



BROWNING
2012 master catalog[®]

2012 master catalog



SHOTGUNS PAGE 2

NEW INTRODUCTIONS	
725 Citori	10-13
A5	6-9
Investor DS	4-5
10 GAUGE: GOLD & BPS	
A5 AUTOLOADING	6-9
A-BOLT	52-53
AUTOLOADING	
A5	6-9
Maxus	32-37
Silver	38-43
BARRELS	
A5	44
BPS	51
Gold	44
Maxus	34
Silver	44
BOLT-ACTION	
BPS PUMP	46-50
BPS EXTRA BARRELS	51
BT-99 TRAP	30-31
CITORI OVER/UNDER	10-21
CYNERGY ACCESSORIES	29
CYNERGY OVER/UNDER	22-29
GOLD EXTRA BARRELS	44
MAXUS AUTOLOADING	32-37
MAXUS EXTRA BARRELS	34
MICRO MIDAS	15, 39, 54-55
OVER AND UNDER	
Citori	10-21
Cynergy	22-29
PUMP	46-50
SILVER AUTOLOADING	38-43
SILVER EXTRA BARRELS	44

RIFLES PAGE 56

A-BOLT	63-67
A-BOLT MAGAZINES	68, 144
AUTOLOADING	
BAR	73-77
Buck Mark	84-85
SA-22	83
BAR	
BAR EXTRA MAGAZINES	76, 145
BAR RECOIL PADS	76
BL-22	81-82
BLR	69-72
BLR MAGAZINES	72, 145
BLR SCOUT MOUNT	71, 142
BOLT-ACTION	
A-Bolt	63-67
T-Bolt	78-80
X-Bolt	56-62
BOSS-CR ACCESSORY	
BUCK MARK	84-85
CUSTOM SHOP	
CENTERFIRE	
A-Bolt	63-67
BAR	73-77
BLR	69-72
X-Bolt	56-62
LEVER-ACTION	
BL-22	81-82
BLR	69-72
MAGAZINES	
A-Bolt	68, 144
BAR	76, 145
BLR	72, 145
T-Bolt Double Helix	79, 145
X-Bolt	60, 143
MICRO MIDAS	55, 57, 81
MOUNTS	71, 142-143
RECOIL PADS	76
RIMFIRE	
BL-22	81-82

Buck Mark	84-85
SA-22	83
T-Bolt	78-80
SA-22	83
T-BOLT	78-80
T-BOLT DOUBLE HELIX MAGAZINE	79, 145
X-BOLT	56-62
X-BOLT EXTRA MAGAZINES	60, 143

PISTOLS PAGE 86

1911-22	86-87
1911-22 MAGAZINES	87, 145
BUCK MARK	88-91
BUCK MARK MAGAZINES	89, 145
HI POWER	92-93
HI POWER MAGAZINES	93, 145

SAFES PAGE 97

ACCESSORY/OPTION INFORMATION

Factory-Installed Accessories	120
Game Scenes	122
Heritage Graphics	122
Interior Options	98, 120
Lock Options	120
User-Installed Accessories	121

FEATURE INFORMATION

Axis Adjustable Shelving	98, 120
Feature Guide	103
Fire Protection	102
Security Features	100-101
Storage	98-99

SAFES: PREMIUM

Gold Series	106-107
Medallion Series	108-109
Platinum Plus Series	104-105
Silver Series	110-111

SAFES: VALUE

Bronze Series	112-113
Compact	113
Sporter	114-115

SAFES: SPECIALTY

Security Door	119
Select Series	118
Tactical Series	116-117
Universal Vault Door	119

GUN CASES PAGE 123

FLOATER CASE	
FLOATER CASE	131
FITTED CASES	
Barrow	125
Canvas Over/Under	127
Crazy Horse Distressed Leather	124
Frisco	125
High Grade Canvas/Crazy Horse Leather	124
John M. Browning Signature	123
Leather/Canvas Universal	125
Sporter	127
Traditional	126
Wild Boar	124
FLEXIBLE CASES	
Bear River Floater	131
Birch Creek	129
Cimmaron	130
Flex Foam Buck Mark Pistol	132, 147
Hidalgo	129
Plainsman	130
Santa Fe	129
Skimmer	131
Talon	131
GUN SLIPS, PLAINSMAN	
GUN SLIPS, PLAINSMAN	130
GUN SOCKS	
GUN SOCKS	131
MOLDED CASES	
Bruiser	128
Mirage	128
PISTOL CASES AND BAGS	
PISTOL CASES AND BAGS	132
TALON ALUMINUM CASES	
TALON ALUMINUM CASES	127

Look for the following icons next to select shotguns to alert you to those ideally suited to clay target shooting:



TRAP



SKEET

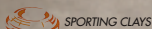

SPORTING CLAYS

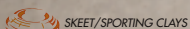

SKEET/SPORTING CLAYS



SKEET/SPORTING CLAYS/FIELD

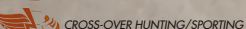

CROSS-OVER HUNTING/SPORTING

BOOKS PAGE 132

ARS MECHANICA	132
JOHN M. BROWNING BIOGRAPHY	132

GUN ACCESSORIES PAGE 133

BAGS	
Shooting	133-135
BINO ACCESSORIES	151
BOSS-CR ACCESSORY	144
CARTRIDGE CASES	149
CHOKE TUBES	
Flush Tubes	155
Extended Tubes	152-154
Injector DS	4-5
Specialty Tubes	153-154
Wrenches	152-155
CHOKE TUBE CASES	149
CLEANING AND GUN CARE ACCESS.	160-161
COMBO KITS	150
DOG TRAINING AND CARE	162-168
HEARING PROTECTION	156-157
MAGAZINES	143-145
MOA SHOOTING STICKS & RESTS	140-141
RANGE KITS	158
RIMFIRE PISTOL ACCESSORIES	146-148
SCOPE RINGS AND BASES	142-143
SHOOTING GLASSES	158
SIGHTS	148, 159
SLINGS	
Synthetic Slings	136-138
Leather Slings	138-139
SNAP CAPS	154

KNIVES PAGE 169

BLACK LABEL TACTICAL BLADES	276-IBC
CAMPING KNIVES	
Backcountry Series	184
Campmate Knife	188
Camp Saws	188
Outdoorsman's Axe and Shears	189
COLLECTIBLE KNIVES	
Crowell/Barker Competition	184
Presentation Lockback	185
Scrimshaw	172
HUNTING AND FISHING KNIVES	
Backcountry Series	184
Big Game	177
Browning 111	182
Crossfox	187
Dirty Bird and Trout	175
Escalade Series	174
Extreme Mountain Hunter	178
Featherweight	177
Field Steel	189
For Her	171
Game Reaper	172
Guide's Choice	174
Hard Core Hunter Combos	173
Kodiak F.D.T.	181
Lil' Bit	179
Obsession Series	181
Outdoorsman Fillet	175
Packer Series	180
Spur Neck	171, 178
Tactical Hunter Series	177
Woodsman Bird and Trout	175
KITCHEN KNIVES	
Outdoorsman Steak Knives	187
Outdoorsman Kitchen Cutlery Set	187
POCKET KNIVES	
Backtrack	182
Classic Series	176
Fast Task Series	185
Gunstock Series	185
Independence	170
Mountain Ti	183
Prism II	183

Sagebrush	186
Wingman	186

LIGHTS PAGE 190

ACCESSORIES/BULBS/BATTERIES	202
CAP LIGHTS	
Night Seeker	199
Night Seeker Pro	199
FLASHLIGHTS	
Alpha and Alpha Max	193
Catalyst	194
Control Point	191
Crossfire	195
Duck Call Lanyard	202
Hi Power	192
Hunt Master and Hunt Master VXT	194
MicroBlast	201
Pro Hunter	195
Spitfire	196
Tactical Hunter	191, 193
Zeta	193
HEADLAMPS	
MicroBlast	198
Nitro	193
Phantom	198
Pro Hunter	197
Renegade	198
KEYCHAIN LIGHTS	
Choke Tube	201
Echo	201
KNIFE/LIGHT COMBOS	200
LANTERNS	202
NIGHT SEEKER POCKET LIGHT	200
PEN LIGHTS	196

CLOTHING PAGE 203

BLAZE	
Big Country Vest	242
Caps	263
Safety Vest	242
BIG GAME	
4X Microfleece	221
650 Down	222
700 Fill Power Down	212
Deluge	215
Dillon WindKill	214
Full Curl Wool	234-237
Hell's Canyon	219-220
High Country	223
Hydro-Fleece PrimaLoft and Soft Shell	206-208
Illusion	213
PrimaLoft	211
Transitions Series	209-215
Wasatch	238-241
XPO Big Game	216-218
CAPS AND HATS	
Camo	261-262
Casual	263-265
Felt Hats	265
Safety	263, 265
Wax Fabric	263
DOWN	
650 Down	222
700 Fill Power Down	212
High Country Jacket	223
FIELDWEAR	
Wasatch	238-241
FOR HER	
650 Down Jacket	222
Caps	262-264
Full Curl Wool	237
High Country Jacket	223
Mohave Short Sleeve Shirt	257
Spartan II Shooting Vest	257
Trapper Creek Mesh Back Shooting Gloves	260
Wasatch	240
XPO Big Game	218

JUNIOR

High Country Jacket	223
Safety Vest	242
Trapper Creek Mesh Shooting Vest	255
Wasatch	240-241
XPO Big Game	218
SHOOTING CLOTHING	
Badger Creek Shirts	258
Ballistic Insulated Shooting Jacket	260
Deluxe Mesh Vest	256
Dusty Mesh Vest	255
Leather Tac-Pro Gloves	260
Mesh Back Gloves	260
Mohave Short Sleeve Shirts	257-258
REACTAR Pad, Harness and Shirt	259
Santa Fe Pro Vest	256
Spartan II Vest For Her	257
SXS Suede Vest	256
Trapper Creek Mesh Vests	254-255
Trapper Creek Mesh Back Gloves	260
SIZING CHART	265



TRANSITIONS SERIES

700 Fill Power Down	212
Deluge	215
Dillon WindKill	214
Illusion	213
NTS Vapor Max	210
PrimaLoft	211

TRANSITIONS: BASE LAYER

NTS Vapor Max	210
---------------	-----

TRANSITIONS: INSULATION LAYER

PrimaLoft	211
700 Fill Power Down	212

TRANSITIONS: PROTECTION LAYER

Deluge	215
Dillon WindKill	214
Illusion	213

UPLAND CLOTHING

Bird'n Lite	246-249
Cross Country	250
Cross Country Pro	251
Game Vests and Bags	253
Pheasants Forever	243-245
Prairielands Shirts	252

WATERFOWL

Dirty Bird	224-232
PrimaLoft	233
Vapor Max	239
Wasatch	238-241

WOOL

Full Curl	234-237
-----------	---------

BUCKMARK DECALS PAGE 266

PRO STAFF PAGE 267-268

BROWNING PRODUCTS PAGE 269

AIR GUNS	273
AUTOMOTIVE	271
BED AND BATH	269
BELTS	269
CAMPING	274
CASUAL SPORTSWEAR	271
OUTDOOR COOKWARE	269
EYEWEAR	270
FISHING	273
FOOTWEAR	270
GIFTS	271
HITCHES	269
METAL PRODUCTS	272
SOCKS	270
SPORTING BAGS/TRAVEL GEAR	274
POLARIS ALL TERRAIN VEHICLES	275

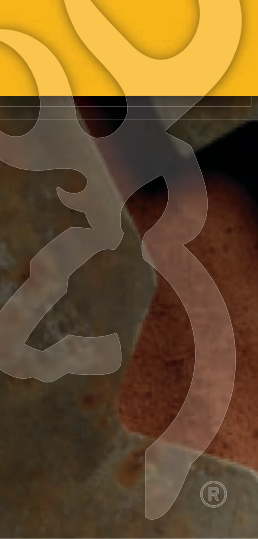

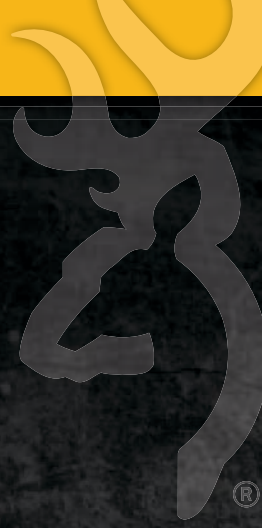

2012
PERFECTION EVOLVED.

725
CITORI

A5™

NEW

INVECTOR-DS

INVECTOR-DS (DOUBLE SEAL) CHOKE SYSTEM

A REVOLUTIONARY STEP FORWARD IN CHOKE TUBES

The new Browning Invector-DS choke tube system is the biggest leap forward in design since interchangeable choke tubes were introduced. With the Invector-DS, we've really done our homework and taken the proven thin wall, muzzle thread choke concept to the next level of shot pattern performance. The exclusive brass alloy band at the base of the tube seals out gas and grit that can work its way between the barrel and tube, making the Invector-DS tubes easy to remove even after extensive shooting. Thin wall construction reduces the flare at the end of the barrel for a sleeker shotgun appearance. Lastly, the Invector-DS offers the most consistent, reliable patterning of any system ever. With all these features, you can't lose with Invector-DS.

Longer overall length, as much as 1 1/8" longer than a leading competitor, allows a gradual choke taper and more parallel surface for denser shot patterns, better pattern percentages and faster shot velocities.

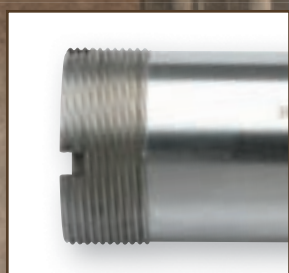
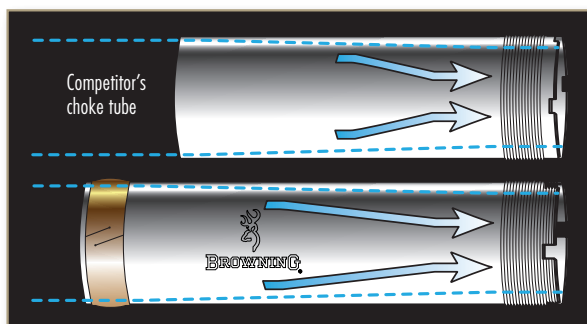

Front threads are precision cut for easy installation and removal, and help minimize barrel flare.



Extended Invector-DS choke tubes have crisp knurling for a sure grip and are clearly marked for easy identification.



All Invector-DS choke tubes are highly polished inside and out and produce dense, predictable patterns.



Invector-DS after extensive shooting



Competitor's tube after extensive shooting



Competitor's tube after extensive shooting

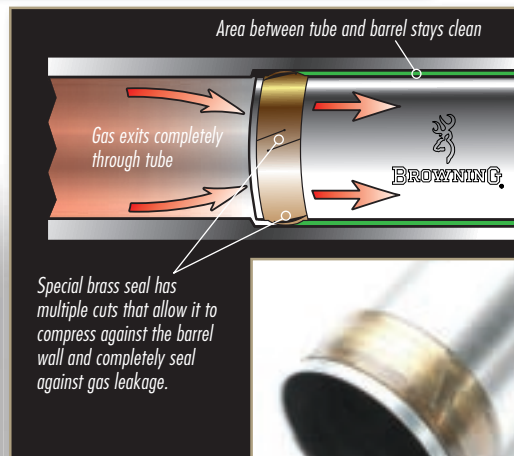

Special brass seal has multiple cuts that allow it to compress against the barrel wall and completely seal against gas leakage.



After extensive shooting, competitors' choke tubes without a gas seal show significant grit and residue build up on the tube. The innovative gas seal on Browning Invector-DS tubes keeps the choke tube cleaner, for easier removal and installation.

EXCLUSIVE BROWNING INVECTOR-DS GAS SEAL

Invector-DS choke tubes feature a proprietary brass seal that prevents gas and grit from slipping into the space between the barrel and choke tube. This durable, long lasting seal compresses tightly against the barrel wall to minimize residue build up on the threads for easier installation and removal than any other choke system with muzzle threads. The seal also helps keep the choke tube snug in the barrel.

THE SHOT PATTERN YOU WANT.

When you thread in a choke tube, you expect it to give you the shot pattern you need for the shooting situation at hand. Invector-DS does this better than any of the competitions' choke systems. From full to cylinder, the internal geometries of Invector-DS choke tubes have been tested again and again to ensure that patterns tighten consistently and reliably. With Invector-DS you get even shot spacing between chokes when it comes to pattern percentages, and the pattern you want when you take the shot.

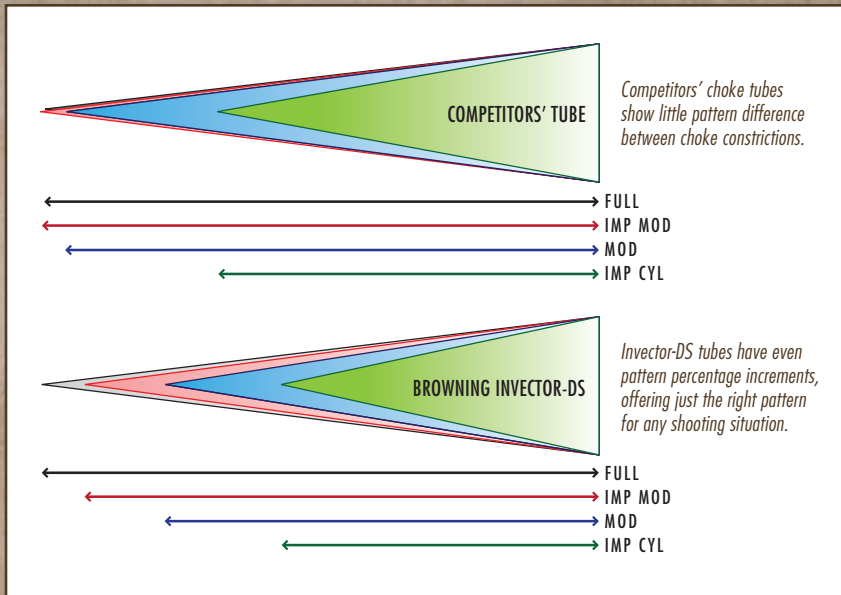

NEW INVECTOR-DS CHOKE TUBES

- Fits flush with the end of the barrel but are longer than competitors' tubes
- Proprietary differential banded gas seal eliminates residue build up and makes chokes easy to remove and install
- Integrated spring suspension holds the seal tight, yet allows expansion against the barrel wall for a perfect fit and a smooth transition for the shot column entering the choke
- Gas is controlled at the interface between choke and where it seats in the bore
- From skeet to full choke, patterns tighten consistently and reliably

DESCRIPTION	12 GA. CODE #	PATTERN PERCENTAGES	SUGG. RETAIL
Full	1133253	75-80 %	\$39.99
Light Full	1133243	70-75 %	39.99
Improved Modified	1133263	65-75 %	39.99
Modified	1133273	55-65 %	39.99
Light Modified	1133233	45-55 %	39.99
Improved Cylinder	1133283	40-45 %	39.99
Skeet	1133293	35-40 %	39.99

Pattern based on the percentage of pellets in a 30" circle at 40 yards.



EXTENDED INVECTOR-DS CHOKE TUBES NEW

- Extends beyond end of barrel for easy removal and even tighter patterns
- Proprietary differential banded gas seal eliminates residue build up and makes chokes easy to remove and install
- Integrated spring suspension holds the seal tight, yet allows expansion against the barrel wall for a perfect fit and a smooth transition for the shot column entering the choke
- Gas is controlled at the interface between choke and where it seats in the bore
- From skeet to full choke, patterns tighten consistently and reliably



DESCRIPTION	12 GA. CODE #	PATTERN PERCENTAGES	SUGG. RETAIL
Full	1134253	75-80 %	\$59.99
Light Full	1134243	70-75 %	59.99
Improved Modified	1134263	65-75 %	59.99
Modified	1134273	55-65 %	59.99
Light Modified	1134233	45-55 %	59.99
Improved Cylinder	1134283	40-45 %	59.99
Skeet	1134293	35-40 %	59.99

Pattern based on the percentage of pellets in a 30" circle at 40 yards.

NEW

TM

A5

COME HELL
OR HIGH WATER

100,000
ROUND GUARANTEE
OR FIVE YEARS



HUMPBACK ACQUISITION ADVANTAGE

GET THE HUMPBACK ACQUISITION ADVANTAGE

Built from rugged and lightweight aircraft-grade aluminum alloy, the A5 receiver's shape is more than a throwback for the sake of nostalgia. The familiar humpback receiver profile melds seamlessly with the rib to extend your sight plane, aiding in natural sight alignment for quicker target acquisition.



INFLEX II TECHNOLOGY

INFLEX II TECHNOLOGY RECOIL PAD

The new Inflex II Technology recoil pad is the next generation of the most recoil absorbing pad available. A softer new outer material provides better lateral stability, even better recoil absorbing performance and is super slippery to prevent snagging on clothing when shouldering. Internal directional deflection construction guides the comb down and away from your cheek for greater shooting comfort and faster, more accurate follow-up shots.

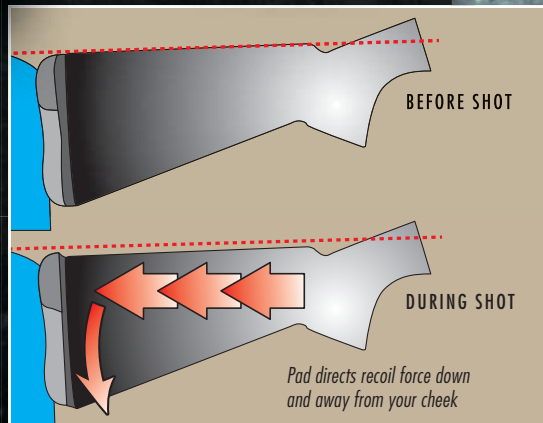



THE NEW A5. THE HUMP IS BACK.

You may notice a family resemblance, but let's get one thing straight — this ain't your Grandpa's Auto-5. In fact, the iconic humpback-shaped receiver is the only thing this new Browning autoloader shares with its legendary namesake. The all new Browning A5 is built to be the most reliable, fastest cycling, best performing and softest shooting recoil-operated (yes, recoil-operated) autoloader on the planet. And we are so confident in the A5, we are standing behind it with a 100,000 round or five-year guarantee that this shotgun will work, come hell or high water. Standing firmly behind this claim is the ultra-reliable, honed to perfection Kinematic Drive System. Other innovations, like the new Invector-DS choke tube system and Inflex II recoil pad are sure to place the A5 right at the top of the industry. With the recoil-operated A5 and our gas-operated Maxus autoloaders, we are poised to dominate every aspect of the autoloading shotgun market. These two guns complement one another in the same way thunder goes with lightning, and the way Browning goes with number one.



KINEMATIC DRIVE™ SYSTEM

In its simplest term, kinetic energy is the energy of motion. The new Browning A5 makes better use of kinetic energy with its powerful, short recoil-operated Kinematic Drive System. Kinematic Drive harnesses recoil energy and converts it into the mechanical motion needed to operate the action. This concept is tried and true, and now perfected by the company that broke ground first with autoloading shotguns. The beauty of Kinematic Drive is the simplicity of design for consistent, reliable function with any load and under the full extremes of weather, temperature, moisture and grime. We believe the new Kinematic Drive is so reliable that the A5 is the first ever autoloading shotgun to carry a 100,000 round or five year guarantee. This gun is designed to work, come hell or high water. Operation is clean because gases are sent out the barrel and away from the action. There's also extreme load versatility. The extensively tested Kinematic Drive offers reliable performance with virtually all loads down to 7/8 ounce light target with no adjustments.



VECTOR PRO™ LENGTHENED FORCING CONE

We were the first manufacturer to recognize the performance advantages of a back-bored barrel and to make it a standard feature on our shotguns. Now we have gone a step further with our Vector Pro lengthened forcing cone. Longer, tapered Vector Pro dimensions minimize shot deformation and maximize pattern uniformity, consistency and density. Back-boring increases bore diameter specifications and decreases friction between the shot cup and the bore to maximize shot pellet velocity and to reduce felt recoil. Reducing constriction from the forcing cone on the shot column results in fewer deformed pellets for more uniform patterns, and keeps more pellets in the central part of the pattern where they're needed to bag more upland birds, waterfowl and clay targets. A larger bore diameter can let gases slip by the shot cup, resulting in both reduced pellet velocity and blown patterns. A smaller bore diameter means the forcing cone can deform pellets, leading to flyers and poor ballistic performance. Our back-bore specifications represent the ideal bore dimensions.



A5 HUNTER GAUGE: 12 | GLOSS FINISH STOCK AND FOREARM

RECEIVER Strong, lightweight aluminum alloy • Black anodized gloss finish **BARREL** Lightweight profile • Flat, ventilated rib **ACTION** 3" chamber • Recoil operated Kinematic Drive is ultra-reliable and cycles a wide range of loads **STOCK** Gloss finish walnut with close radius pistol grip • Sharp 22 lines-per-inch checkering • Shim adjustable for cast and drop **FEATURES** Vector Pro™ lengthened forcing cone • Three Invector-DS™ choke tubes • Inflex II Technology recoil pad • Brass front bead sight • Ivory mid-bead sight • One 1/4" stock spacer and one 1/2" stock spacer, plus lengthened screws for total length of pull adjustment of 3/4" • Included ABS case (not shown)



GA.	BARREL LENGTH	CODE NUMBER	CHOKES INCLUDED	CHAMBER	*AVG. WEIGHT	OVERALL LENGTH	DROP AT COMB	DROP AT HEEL	LENGTH OF PULL	RIB WIDTH	SUGG. RETAIL
NEW	12 30"	0118003003	F, M, IC	3"	6 lbs. 15 oz.	51 3/8"	1 3/4"	2"	14 1/4"	1/4"	\$1,559.99
NEW	12 28"	0118003004	F, M, IC	3"	6 lbs. 13 oz.	49 3/8"	1 3/4"	2"	14 1/4"	1/4"	1,559.99
NEW	12 26"	0118003005	F, M, IC	3"	6 lbs. 11 oz.	47 3/8"	1 3/4"	2"	14 1/4"	1/4"	1,559.99

A FULL SELECTION OF EXTRA BARRELS FOR THE A5 ARE LISTED ON PAGE 44.

*NOTE: Weights listed are approximate.



Features and looks are only part of the A5 equation for success. The new A5 feels incredibly balanced in your hands from pad to muzzle. It feels light and swings fast. Put an A5 to the real test by picking one up. The grip is comfortable, and the forearm is compact and narrow, placing your front hand closer to the bore line for superior hand-eye coordination and pointability.



All Browning firearms are shipped with a free locking device to assist in the safe storage of firearms.



After 500 rounds of steel shot, the higher-quality Browning barrel shows no wear.



The forcing cone of the competition's barrel is pitted and damaged beyond repair after 500 rounds of steel shot.

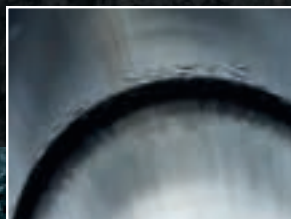

STEEL SHOT PERFORMANCE

The strength of a Browning barrel is legendary, and is built to handle the punishment of steel shot. Unlike some manufacturers' barrels whose guns face an uncertain future after shooting steel, we have long been at the forefront of dependable steel shot performance and durability. Our barrels meet the strictest material and construction quality standards. The barrel blanks are made from rolled and tempered steel bars and are stress relieved to offer exceptional mechanical properties. The barrel blanks are then precision drilled, reamed and honed to exacting specifications. With proper care, a Browning A5 barrel will last a lifetime.

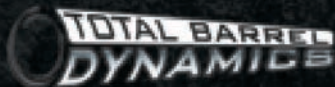

TURNKEY MAGAZINE PLUG

The patented TurnKey Magazine Plug is easily removed in seconds using a vehicle key, allowing the magazine plug to be removed in mere seconds.



SPEED LOAD PLUS

Speed Loading has been popular on Browning autoloaders for decades. Our patented feeding system sends the first shell loaded into the magazine directly into the chamber. Unloading is just as easy with the Speed Unload feature that makes emptying the magazine fast and easy, without having to cycle and chamber every shell with the bolt handle.



ERGONOMIC BOLT LATCH

The A5 includes a Bolt Latch located just ahead of the trigger guard. This handy addition locks the bolt to the rear when the magazine is unloaded and releases a shell from the magazine when the bolt is closed to make loading quick. The oversized shape makes the Bolt Latch easy to locate and operate with or without gloves.



A5 STALKER

GAUGE: 12 | DURA-TOUCH® ARMOR COATING ON STOCK AND FOREARM

NEW

RECEIVER Strong, lightweight aluminum alloy **BARREL** Lightweight profile • Flat, ventilated rib **ACTION** 3" chamber • Recoil operated Kinematic Drive is ultra-reliable and cycles a wide range of loads **STOCK** Composite with close radius pistol grip • Textured gripping surfaces • Shim adjustable for cast and drop • Matte black finish • Dura-Touch® Armor Coating **FEATURES** Vector Pro™ lengthened forcing cone • Three Invector-DS™ choke tubes • Inflex II Technology recoil pad • Fiber-optic front sight • One ¼" stock spacer and one ½" stock spacer, plus lengthened screws for total length of pull adjustment of ¾" • Included ABS case (not shown)

Includes ABS Case

A5, MOSSY OAK® DUCK BLIND®

GAUGE: 12 | DURA-TOUCH® ARMOR COATING ON STOCK AND FOREARM

NEW

Includes ABS Case

RECEIVER Strong, lightweight aluminum alloy **BARREL** Lightweight profile • Flat, ventilated rib **ACTION** 3" chamber • Recoil operated Kinematic Drive is ultra-reliable and cycles a wide range of loads **STOCK** Composite with close radius pistol grip • Textured gripping surfaces • Shim adjustable for cast and drop • Mossy Oak® Duck Blind® camo finish • Dura-Touch® Armor Coating **FEATURES** Vector Pro™ lengthened forcing cone • Three Invector-DS™ choke tubes • Inflex II Technology recoil pad • Fiber-optic front sight • One ¼" stock spacer and one ½" stock spacer, plus lengthened screws for total length of pull adjustment of ¾" • Included ABS case (not shown)

A5, MOSSY OAK® BREAK-UP INFINITY®

GAUGE: 12 | DURA-TOUCH® ARMOR COATING ON STOCK AND FOREARM

NEW

Includes ABS Case

RECEIVER Strong, lightweight aluminum alloy **BARREL** Lightweight profile • Flat, ventilated rib **ACTION** 3" chamber • Recoil operated Kinematic Drive is ultra-reliable and cycles a wide range of loads **STOCK** Composite with close radius pistol grip • Textured gripping surfaces • Shim adjustable for cast and drop • Mossy Oak® Break-Up Infinity® camo finish • Dura-Touch® Armor Coating **FEATURES** Vector Pro™ lengthened forcing cone • Three Invector-DS™ choke tubes • Inflex II Technology recoil pad • Fiber-optic front sight • One ¼" stock spacer and one ½" stock spacer, plus lengthened screws for total length of pull adjustment of ¾" • Included ABS case (not shown)

INVECTOR-DS

INVECTOR-DS™ CHOKE SYSTEM

Better patterning, lighter weight and a sleeker barrel profile are all reasons to check out the new Invector-DS (Double Seal) interchangeable choke tube system. The combination of muzzle-end threads and thin-wall construction allowed us to design a longer, more gradually tapered choke tube that results in more evenly scaled patterns. From cylinder to extra full, patterns tighten consistently in reliable steps. The longer choke taper also produces extremely consistent, dense shot patterns. The flare at the end of the barrel that accommodates the choke tube is also greatly reduced for improved shotgun appearance. A slightly lighter overall barrel weight is achieved for faster swinging and improved balance.

Invector-DS choke tubes have been tested and proven to reduce shot deformation for fewer flyers and gaps in the pattern. The more gradual taper also allows higher shot velocities for hard hitting performance.

To prevent gas and fouling from slipping between the barrel and choke tube we've added a proprietary differential-banded brass seal. This seal compresses against the barrel wall when tightened to keep the choke tube threads clean and make installation and removal easier than any other muzzle thread system. It also keeps the tube snug in the barrel. View the full line of new Invector-DS choke tubes on pages 4-5.



GA.	BARREL LENGTH	CODE NUMBER	CHOKES INCLUDED	CHAMBER	*AVG. WEIGHT	OVERALL LENGTH	DROP AT COMB	DROP AT HEEL	LENGTH OF PULL	RIB WIDTH	SUGG. RETAIL	
A5 STALKER												
NEW	12	30"	0118013003	F, M, IC	3"	7 lbs. 7 oz.	51½"	1¼"	2"	14¼"	¼"	\$1,399.99
NEW	12	28"	0118013004	F, M, IC	3"	7 lbs. 5 oz.	49½"	1¼"	2"	14¼"	¼"	1,399.99
NEW	12	26"	0118013005	F, M, IC	3"	7 lbs. 3 oz.	47½"	1¼"	2"	14¼"	¼"	1,399.99
A5, MOSSY OAK DUCK BLIND												
NEW	12	30"	0118033003	F, M, IC	3"	7 lbs. 7 oz.	51½"	1¼"	2"	14¼"	¼"	\$1,559.99
NEW	12	28"	0118033004	F, M, IC	3"	7 lbs. 5 oz.	49½"	1¼"	2"	14¼"	¼"	1,559.99
NEW	12	26"	0118033005	F, M, IC	3"	7 lbs. 3 oz.	47½"	1¼"	2"	14¼"	¼"	1,559.99
A5, MOSSY OAK BREAK-UP INFINITY												
NEW	12	30"	0118023003	F, M, IC	3"	7 lbs. 7 oz.	51½"	1¼"	2"	14¼"	¼"	\$1,559.99
NEW	12	28"	0118023004	F, M, IC	3"	7 lbs. 5 oz.	49½"	1¼"	2"	14¼"	¼"	1,559.99
NEW	12	26"	0118023005	F, M, IC	3"	7 lbs. 3 oz.	47½"	1¼"	2"	14¼"	¼"	1,559.99

A FULL SELECTION OF EXTRA BARRELS FOR THE A5 ARE LISTED ON PAGE 44.

*NOTE: Weights listed are approximate.

VECTORPRO



BACK-BORED TECHNOLOGY

NEW

SHOTGUNS

725

CITORI

BECOME
ONE
WITH THE
GUN

AT LONG LAST, WE BRING
YOU THE NEW CITORI
725. IT IS LOWER,
LIGHTER, FASTER AND
EVERY BIT AS RUGGED
AS THE CITORI
LEGEND DEMANDS.



**FIRE
LITE**
MECHANICAL
TRIGGER

FIRE LITE MECHANICAL TRIGGER

The exclusive new Fire Lite Mechanical Trigger is a big part of the Citori 725's performance package. Unlike an inertia trigger, Fire Lite does not rely on recoil to set the next shot. Instead, you get immediate second shot capability. The innovative design features reduced take up, a crisp break and shorter overtravel.

THE NEW CITORI 725 — BECOME ONE WITH THE GUN.

The new Citori 725 is the evolution of John M. Browning's legendary B25 Superposed, now with the modern performance advantage of a low-profile receiver. The new 725 receiver is significantly lower than other Citori 12 gauge receivers, yet the 725 shares the renowned durability of generations of Citori over and unders with the rugged full-width hinge pin and tapered locking bolt design. With a 725, you get the "one with the gun" feeling you want, with the long lasting durability you expect from a Browning over and under. And the features don't stop there. The 725 showcases the all-new Fire Lite mechanical trigger that offers unmatched feel and lighter pull weights than ever before. Inflex II Technology has also been added to make shooting more comfortable. On top of it all is a beautiful look that, while familiar, is sleek and fresh. The Citori 725, get your hands on the next over and under performance tradition.

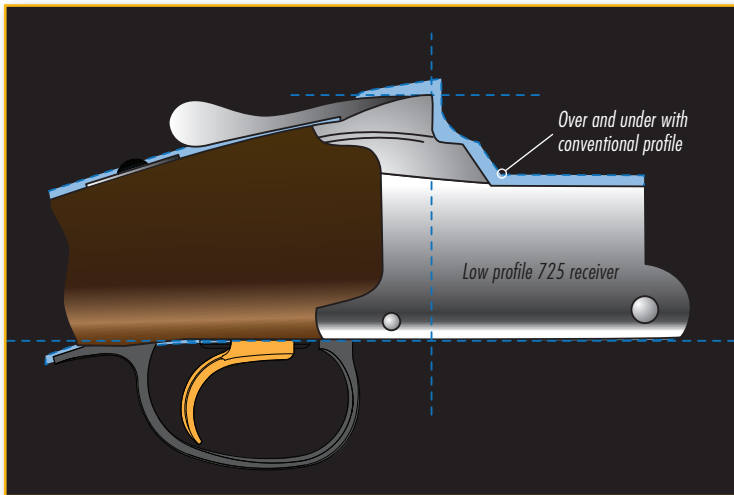

Improved recoil control and less muzzle jump are two of the big benefits of a low-profile receiver. There is also the "one with the gun" feeling that makes the shotgun act like an extension of your body.

ERGO
BALANCED

The new low-profile receiver makes the Citori 725 feel incredibly balanced in your hands, and gives you the "one with the gun" feeling you want. Put a 725 to the real test by picking one up. The 725 feels light and swings fast. The grip is comfortable, and the forearm is narrow and sleek to place your front hand closer to the bore line for superior hand-eye coordination and pointability.

725 FIELD



GAUGE: 12 | GLOSS OIL FINISH STOCK AND FOREARM

RECEIVER Steel • Low-profile • Silver nitride finish • Accented, high-relief engraving **BARREL** Ventilated top rib **ACTION** Mechanical trigger system • Hammer ejectors • Top-tang barrel selector/safety **STOCK** Gloss oil finish Grade II/III walnut with close radius pistol grip **FEATURES** Vector Pro™ lengthened forcing cones • Three Invector-DS™ choke tubes • Ivory front and mid-bead sights

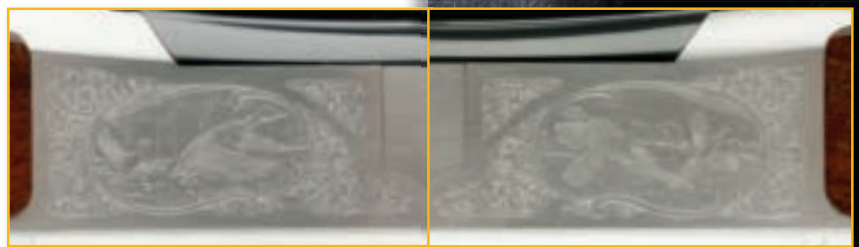

725 Field Engraving, Right

725 Field Engraving, Left

	GA.	BARREL LENGTH	CODE NUMBER	CHOKES INCLUDED	CHAMBER	*AVG. WEIGHT	OVERALL LENGTH	DROP AT COMB	DROP AT HEEL	LENGTH OF PULL	RIB WIDTH	SUGG. RETAIL
NEW	12	28"	0135303004	F, M, IC	3"	7 lbs. 6 oz.	45¾"	1⅝"	2½"	14¼"	¼"	\$2,469.99
NEW	12	26"	0135303005	F, M, IC	3"	7 lbs. 4 oz.	43¾"	1⅝"	2½"	14¼"	¼"	2,469.99

*NOTE: Weights listed are approximate.



All Browning firearms are shipped with a free locking device to assist in the safe storage of firearms.

725 CITORI

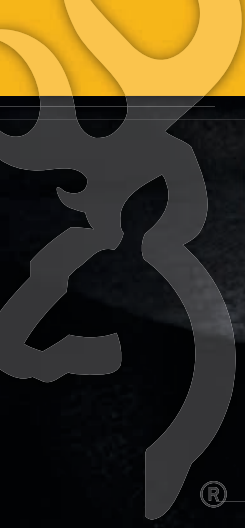

LOCKING BOLT AND HINGE PIN

Unlike other low profile over and unders, the Citori 725 features a transverse-mounted, full-width tapered locking bolt and full-width hinge pin to maintain the legendary Browning strength and reliability counted on for generations. The locking bolt engages a full-width tapered recess in the rear barrel lugs. Tapering the bolt and recess allows the bolt to seat deeper, accommodating for wear. Unlike guns with side-mounted trunnions, the 725's hinge pin extends the full width of the receiver for maximum strength. Like the original Citori, the 725 is engineered to wear in, not out.

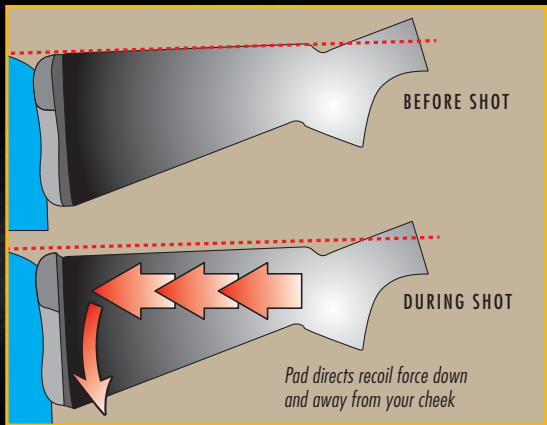

The 725's full width hinge pin provides maximum strength and long-lasting endurance.



INFLEX II TECHNOLOGY

NEW INFLEX II TECHNOLOGY RECOIL PAD

The new Inflex II Technology recoil pad is the next generation of the most recoil absorbing pad available. A softer new material provides better lateral stability, even better recoil absorbing performance and is super slippery to prevent snagging on clothing when shouldering. Internal directional deflection construction guides the comb down and away from your cheek for greater shooting comfort and faster, more accurate follow-up shots.

The competitors' trunnions are weaker and provide only a fraction of the bearing surface that the 725's full-width hinge pin provides.



BECOME
**ONE
WITH THE
GUN**

TRIPLE TRIGGER SYSTEM

All 725 target shotguns come equipped with the Triple Trigger™ System, which fine tunes finger-to-trigger length of pull. Choose a wide checkered, narrow smooth or wide smooth canted trigger shoe.



THE BEST TARGET SHOTGUN EVER BUILT.

Many over and under shooters prefer a low-profile receiver. The lower profile moves the shotgun down and into your body for improved recoil control and reduced muzzle jump for faster target acquisition and more accurate follow up shots. There is also that “one with the gun” feeling, the sensation that the shotgun is an extension of your body that just feels natural and inspires confidence. The new Citori 725 delivers all this without compromising the legendary durability that Browning shotguns are known for. Unlike other low profile guns that rely on undersized trunnions and narrow, tapered pins to lock up their receivers, the 725 still has the rugged full-width hinge pin and transverse mounted locking bolt design of the original Citori. That means the 725 is built strong enough to compete year after year and round after round of breaking clay targets. While this kind of use will wear out lesser low profile over and unders, it simply wears a Citori in. If that isn’t enough, the new Fire Lite mechanical trigger delivers a smooth pull with a light squeeze. Inflex II Technology recoil control keeps you shooting all day with none of the beat down feeling you get with lesser recoil pads. With all the strength of the legendary Citori, plus all the performance and recoil absorbing advantages of a lower profile, the 725 is the total performance package.

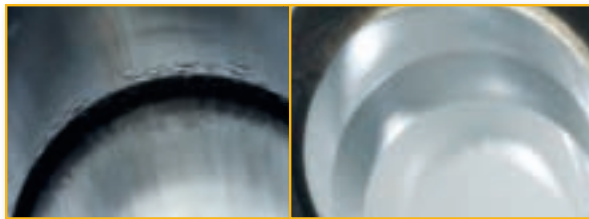

The forcing cone of the competition's barrel is pitted and damaged beyond repair after 500 rounds of steel shot.

After 500 rounds of steel shot, the higher-quality Browning barrel shows no wear.

STEEL SHOT PERFORMANCE

Our barrels are made to handle the punishment of steel shot. Unlike some manufacturers whose guns face an uncertain future after shooting steel, we have long been at the forefront of dependable steel shot performance and durability. Our barrels meet the strictest material and construction quality standards. The barrel blanks are made from rolled and tempered steel bars and are stress relieved to offer exceptional mechanical properties. The barrel blanks are then precision drilled, reamed and honed to exacting specifications. With proper care, Browning Citori 725 barrels will last a lifetime.



INVECTOR-DS™ CHOKE SYSTEM

BETTER PATTERNING, LIGHTER WEIGHT AND A SLEEKER BARREL PROFILE ARE ALL REASONS TO CHECK OUT THE NEW INVECTOR-DS (DOUBLE SEAL) INTERCHANGEABLE CHOKE TUBE SYSTEM.

The combination of muzzle-end threads and thin-wall construction allowed us to design a longer, more gradually tapered choke tube that results in more evenly scaled patterns. From cylinder to extra full, patterns tighten consistently in reliable steps. The longer choke taper also produces extremely consistent, dense shot patterns. The flare at the end of the barrel that accommodates the choke tube is also greatly reduced for improved shotgun appearance and a slightly lighter overall barrel weight is achieved for faster swinging and improved balance. Invector-DS choke tubes have been tested and proven to reduce shot deformation for fewer flyers and gaps in the pattern. The more gradual taper also allows higher shot velocities for hard hitting performance. To prevent gas and fouling from slipping between the barrel and choke tube we've added a proprietary differential-banded brass seal. This seal compresses against the barrel wall when tightened to keep the choke tube threads clean and make installation and removal easier than any other muzzle thread system. It also keeps the tube snug in the barrel. View the full line of new Invector-DS choke tubes on pages 4-5.

725 SPORTING

GAUGE: 12 | GLOSS OIL FINISH STOCK AND FOREARM



RECEIVER Steel • Low-profile • Silver nitride finish • Gold accented engraving **BARREL** Ventilated top and side ribs • Ported **ACTION** Mechanical trigger system • Hammer ejectors • Top-tang barrel selector/safety **STOCK** Gloss oil finish Grade III/IV walnut with close radius pistol grip **FEATURES** Vector Pro™ lengthened forcing cones • Five Invector-DS™ choke tubes • Triple Trigger™ System • HiViz® Pro-Comp sight and ivory mid-bead

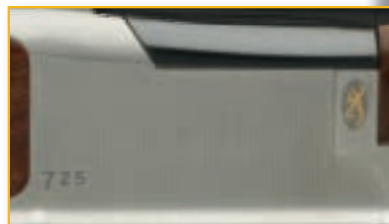

725 Sporting Engraving, Right



725 Sporting Engraving, Bottom

	GA.	BARREL LENGTH	CODE NUMBER	CHOKES INCLUDED	CHAMBER	*AVG. WEIGHT	OVERALL LENGTH	DROP AT COMB	DROP AT HEEL	LENGTH OF PULL	RIB WIDTH	SUGG. RETAIL
NEW	12	32"	0135313009	F, IM, M, IC, SK	3"	7 lbs. 10 oz.	50"	1 1/8"	2 1/2"	14 3/4"	(5/16" - 7/16")	\$3,139.99
NEW	12	30"	0135313010	F, IM, M, IC, SK	3"	7 lbs. 8 oz.	48"	1 1/8"	2 1/2"	14 3/4"	(5/16" - 7/16")	3,139.99
NEW	12	28"	0135313011	F, IM, M, IC, SK	3"	7 lbs. 6 oz.	46"	1 1/8"	2 1/2"	14 3/4"	(5/16" - 7/16")	3,139.99

*NOTE: Weights listed are approximate.





TRIPLE TRIGGER SYSTEM

All Sporting Clays, XT and XS Series Citori shotguns come equipped with the Triple Trigger™ System, which fine tunes finger-to-trigger length of pull. Choose a wide checkered, narrow smooth or wide smooth canted trigger shoe.



LOCKING BOLT AND HINGE PIN

The Citori features a heavy-duty, transverse-mounted, full-width tapered locking bolt that engages a full-width tapered recess in the rear barrel lugs. Tapering the bolt and recess allows the bolt to seat deeper, accommodating for wear. The hinge pin extends across the width of the receiver for maximum strength. Engineering like this ensures the Citori wears in, not out.

HAMMERS AND HAMMER EJECTORS

For positive primer ignition, Citori hammers are driven by powerful coil-type mainsprings. The convenient barrel selector allows a shooter to choose which barrel fires on the first pull of the single trigger, and the second pull fires the remaining barrel. Ejectors are fired by a sharp hammer blow for more positive ejection than the push imparted by competitors' ejectors. The automatic ejectors eject fired hulls when the breech is opened and elevate unfired shells for easy removal.

HAND-FINISHED PERFECTION. Often we hear "you get

what you pay for." That isn't entirely true, because with a Browning Citori, you get much more. The Citori boasts a level of hand fitting, polishing and assembly that rivals guns often costing hundreds or even thousands of dollars more. The extra attention to detail in every Citori does more than assure smooth operation and flawless looks. It adds longevity and integrity to the gun so it's ready for the next generation. Looking for a high performance, high value over and under for a pheasant, quail or dove hunt? Get your hands on a Citori.

All Browning firearms are shipped with a free locking device to assist in the safe storage of firearms.

VECTOR PRO™ LENGTHENED FORCING CONES ON 12 AND 20 GAUGE CITORI SHOTGUNS VECTORPRO™

We were the first manufacturer to recognize the performance advantages of a back-bored barrel and to make it a standard feature on our shotguns. Now we have gone a step further with our Vector Pro lengthened forcing cone. Longer, tapered Vector Pro dimensions minimize shot deformation and maximize pattern uniformity, consistency and density. Back-boring increases bore diameter specifications and decreases friction between the shot cup and the bore to maximize shot pellet velocity and to reduce felt recoil. Reducing constriction from the forcing cone on the shot column results in fewer deformed pellets for more uniform patterns, and keeps more pellets in the central part of the pattern where they're needed to bag more upland birds, waterfowl and clay targets. A larger bore diameter can let gases slip by the shot cup, resulting in both reduced pellet velocity and blown patterns. A smaller bore diameter means the forcing cone can deform pellets, leading to flyers and poor ballistic performance. Our back-bore specifications represent the ideal bore dimensions.

INVECTOR™ CHOKE TUBE SYSTEMS

The proven Standard Invector (28 gauge, .410 bore) or Invector-Plus™ (12, 20 gauge) interchangeable choke tube systems are featured on every Citori shotgun (except Citori 725) and provide consistent, dense shot patterns in the constriction needed for the specific shooting situation. The longer choke taper inside an Invector-Plus choke tube works with back-bored barrels and Vector Pro™ lengthened forcing cones to produce dense patterns with uniform densities and fewer flyers. The superior designs of the Invector systems are far more durable than the choke systems found in competitors' guns, especially when shooting steel shot loads. The Invector systems eliminate gases slipping between the choke tube and barrel that could damage both the choke tube and the barrel. See pages 152 to 155 for a complete listing of choke tubes.



STEEL SHOT PERFORMANCE

The strength of Browning barrels is legendary, and built to handle the punishment of steel shot. Unlike some manufacturers' barrels that show pitting after shooting steel, we have pioneered construction that maximizes steel shot performance and barrel durability. Our barrels meet the strictest material and construction quality standards. The barrel blanks are made from rolled and tempered steel bars and are stress relieved to offer exceptional mechanical properties. The barrel blanks are then precision drilled, reamed and honed to exacting specifications. With proper care, Browning Citori barrels will last a lifetime.

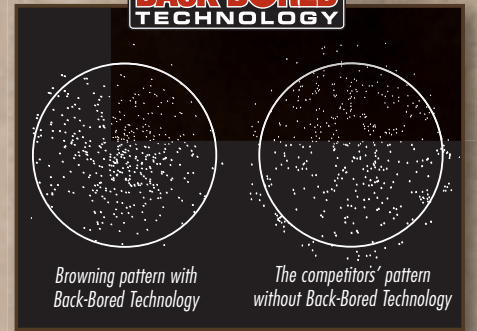

CHROME CHAMBERS

For increased durability and corrosion resistance, all Citori shotguns have hard chrome-plated chambers to resist the toll that thousands of shells can take on lesser quality guns.

Eligible for the Growth Insurance Program. See page 31 for details.

CITORI SATIN HUNTER, MICRO MIDAS GAUGE: 12 (SHOWN), 20 | SATIN FINISH STOCK AND FOREARM

RECEIVER Steel • Blued finish **BARREL** Ventilated rib **ACTION** Single selective trigger • Hammer ejectors • Top-tang barrel selector/safety **STOCK** Satin finish walnut • Compact stock with 13" length of pull **FEATURES** Vector Pro™ lengthened forcing cone • Three Invector-Plus™ choke tubes • Ventilated recoil pad • Ivory front bead sight

GA.	BARREL LENGTH	CODE NUMBER	CHOKES INCLUDED	CHAMBER	*AVG. WEIGHT	OVERALL LENGTH	DROP AT COMB	DROP AT HEEL	LENGTH OF PULL	RIB WIDTH	SUGG. RETAIL
12	26"	013497305	F, M, IC	3"	7 lbs. 12 oz.	41 3/4"	1 3/8"	2 1/2"	13"	3/8"	\$1,599.99
12	24"	013497306	F, M, IC	3"	7 lbs. 10 oz.	39 3/4"	1 3/8"	2 1/2"	13"	3/8"	1,599.99
20	26"	013497605	F, M, IC	3"	6 lbs. 1 oz.	41 3/4"	1 1/2"	2 3/8"	13"	1/4"	1,599.99
20	24"	013497606	F, M, IC	3"	5 lbs. 15 oz.	39 3/4"	1 1/2"	2 3/8"	13"	1/4"	1,599.99

*NOTE: Weights listed are approximate.



Citori White Lightning, Right

CITORI WHITE LIGHTNING

GAUGE: 12, 20 (SHOWN), 28, .410 | GLOSS OIL FINISH STOCK AND FOREARM

- RECEIVER** Steel • Silver nitride finish • High-relief engraving
BARREL Ventilated rib **ACTION** Single selective trigger • Hammer ejectors
 • Top-tang barrel selector/safety **STOCK** Gloss oil finish Grade II/III walnut
 • Lightning-style stock and forearm **FEATURES** Vector Pro™ lengthened forcing cones on 12 and 20 • Three Invector-Plus™ choke tubes on 12 and 20 • Three Standard Invector™ on 28 and .410 • Recoil pad on 12 gauge model • Ivory front bead sight

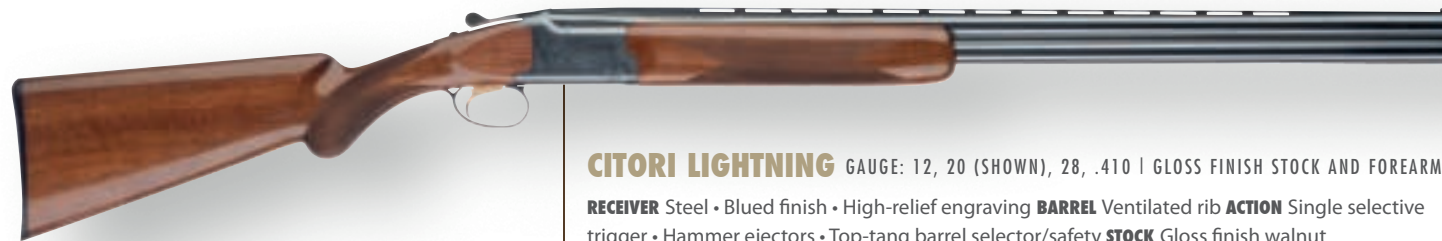

CITORI LIGHTNING GAUGE: 12, 20 (SHOWN), 28, .410 | GLOSS FINISH STOCK AND FOREARM

- RECEIVER** Steel • Blued finish • High-relief engraving **BARREL** Ventilated rib **ACTION** Single selective trigger • Hammer ejectors • Top-tang barrel selector/safety **STOCK** Gloss finish walnut
 • Lightning-style stock and forearm **FEATURES** Vector Pro™ lengthened forcing cones on 12 and 20
 • Three Invector-Plus™ choke tubes on 12 and 20 • Three Standard Invector™ on 28 and .410
 • Recoil pad on 12 gauge model (see Grade IV and VII models on page 21) • Ivory front bead sight



Citori Lightning, Right

GA.	BARREL LENGTH	CODE NUMBER	CHOKES INCLUDED	CHAMBER	*AVG. WEIGHT	OVERALL LENGTH	DROP AT COMB	DROP AT HEEL	LENGTH OF PULL	RIB WIDTH	SUGG. RETAIL
CITORI WHITE LIGHTNING											
12	28"	013462304	F, M, IC	3"	8 lbs. 2 oz.	45"	1 5/8"	2 1/2"	14 1/4"	5/16"	\$2,069.99
12	26"	013462305	F, M, IC	3"	8 lbs.	43"	1 5/8"	2 1/2"	14 1/4"	5/16"	2,069.99
20	28"	013462604	F, M, IC	3"	6 lbs. 9 oz.	45"	1 1/2"	2 3/8"	14 1/4"	1/4"	2,069.99
20	26"	013462605	F, M, IC	3"	6 lbs. 7 oz.	43"	1 1/2"	2 3/8"	14 1/4"	1/4"	2,069.99
28	28"	013462813	F, M, IC	2 3/4"	6 lbs. 12 oz.	45"	1 1/2"	2 3/8"	14 1/4"	1/4"	2,139.99
28	26"	013462814	F, M, IC	2 3/4"	6 lbs. 10 oz.	43"	1 1/2"	2 3/8"	14 1/4"	1/4"	2,139.99
.410	28"	013462913	F, M, IC	3"	6 lbs. 10 oz.	45"	1 1/2"	2 3/8"	14 1/4"	1/4"	2,139.99
.410	26"	013462914	F, M, IC	3"	6 lbs. 8 oz.	43"	1 1/2"	2 3/8"	14 1/4"	1/4"	2,139.99
CITORI LIGHTNING											
12	28"	013461304	F, M, IC	3"	8 lbs. 2 oz.	45"	1 5/8"	2 1/2"	14 1/4"	5/16"	\$1,989.99
12	26"	013461305	F, M, IC	3"	8 lbs.	43"	1 5/8"	2 1/2"	14 1/4"	5/16"	1,989.99
20	28"	013461604	F, M, IC	3"	6 lbs. 9 oz.	45"	1 1/2"	2 3/8"	14 1/4"	1/4"	1,989.99
20	26"	013461605	F, M, IC	3"	6 lbs. 7 oz.	43"	1 1/2"	2 3/8"	14 1/4"	1/4"	1,989.99
28	28"	013461813	F, M, IC	2 3/4"	6 lbs. 12 oz.	45"	1 1/2"	2 3/8"	14 1/4"	1/4"	2,069.99
28	26"	013461814	F, M, IC	2 3/4"	6 lbs. 10 oz.	43"	1 1/2"	2 3/8"	14 1/4"	1/4"	2,069.99
.410	28"	013461913	F, M, IC	3"	6 lbs. 10 oz.	45"	1 1/2"	2 3/8"	14 1/4"	1/4"	2,069.99
.410	26"	013461914	F, M, IC	3"	6 lbs. 8 oz.	43"	1 1/2"	2 3/8"	14 1/4"	1/4"	2,069.99

*NOTE: Weights listed are approximate.

VECTORPRO™



BACK-BORED TECHNOLOGY

NEW



CITORI FEATHER LIGHTNING GAUGE: 12 (SHOWN), 20 | GLOSS OIL FINISH STOCK AND FOREARM

RECEIVER Lightweight alloy with steel breech face and hinge pin • High-relief engraving **BARREL** Ventilated rib **ACTION** Single selective trigger • Hammer ejectors • Top-tang barrel selector/safety **STOCK** Gloss oil finish Grade II/III walnut • Lightning-style stock and forearm **FEATURES** Vector Pro™ lengthened forcing cones • Three Invector-Plus™ choke tubes • Ivory front bead sight



Citori Feather Lightning, Right



CITORI 625 FEATHER, SMALL GAUGE

GAUGE: 20 (SHOWN), 28, .410 | GLOSS OIL FINISH STOCK AND FOREARM

RECEIVER Lightweight alloy with steel breech face and hinge pin • High-relief engraving **BARREL** Lightweight profile • Ventilated rib **ACTION** Single selective trigger • Hammer ejectors • Top-tang barrel selector/safety **STOCK** Gloss oil finish Grade II/III walnut stock with close radius pistol grip • Schnabel forearm **FEATURES** Vector Pro™ lengthened forcing cones on 20 • Three Invector-Plus™ choke tubes on 20 • Three Standard Invector™ on 28 and .410 • Ivory front bead sight



Citori 625 Feather, Small Gauge, Right



CITORI 625 FIELD, SMALL GAUGE

GAUGE: 20 (SHOWN), 28, .410 | GLOSS OIL FINISH STOCK AND FOREARM

RECEIVER Steel • Silver nitride finish • High-relief engraving **BARREL** Lightweight profile • Ventilated rib **ACTION** Single selective trigger • Hammer ejectors • Top-tang barrel selector/safety **STOCK** Gloss oil finish Grade II/III walnut stock with close radius pistol grip • Schnabel forearm **FEATURES** Vector Pro™ lengthened forcing cones on 20 • Three Invector-Plus™ choke tubes on 20 • Three Standard Invector™ on 28 and .410 • Ivory front bead sight



Citori 625 Field, Small Gauge, Left



Citori 625 Field, Small Gauge, Right

GA.	BARREL LENGTH	CODE NUMBER	CHOKES INCLUDED	CHAMBER	*AVG. WEIGHT	OVERALL LENGTH	DROP AT COMB	DROP AT HEEL	LENGTH OF PULL	RIB WIDTH	SUGG. RETAIL
CITORI FEATHER LIGHTNING											
NEW 12	28"	013534304	F, M, IC	3"	6 lbs. 9 oz.	45"	1 3/8"	2 1/2"	14 1/4"	1/4"	\$2,179.99
NEW 12	26"	013534305	F, M, IC	3"	6 lbs. 7 oz.	43"	1 3/8"	2 1/2"	14 1/4"	1/4"	2,179.99
NEW 20	28"	013534604	F, M, IC	3"	6 lbs.	45"	1 1/2"	2 3/8"	14 1/4"	1/4"	2,179.99
NEW 20	26"	013534605	F, M, IC	3"	5 lbs. 14 oz.	43"	1 1/2"	2 3/8"	14 1/4"	1/4"	2,179.99
CITORI 625 FEATHER, SMALL GAUGE											
20	28"	013427604	F, M, IC	3"	5 lbs. 8 oz.	45"	1 1/2"	2 3/8"	14 1/4"	1/4"	\$2,779.99
20	26"	013427605	F, M, IC	3"	5 lbs. 6 oz.	43"	1 1/2"	2 3/8"	14 1/4"	1/4"	2,779.99
28	28"	013427813	F, M, IC	2 3/4"	5 lbs. 11 oz.	45"	1 1/2"	2 3/8"	14 1/4"	1/4"	2,859.99
28	26"	013427814	F, M, IC	2 3/4"	5 lbs. 9 oz.	43"	1 1/2"	2 3/8"	14 1/4"	1/4"	2,859.99
.410	28"	013427913	F, M, IC	3"	5 lbs. 13 oz.	45"	1 1/2"	2 3/8"	14 1/4"	1/4"	2,859.99
.410	26"	013427914	F, M, IC	3"	5 lbs. 11 oz.	43"	1 1/2"	2 3/8"	14 1/4"	1/4"	2,859.99
CITORI 625 FIELD, SMALL GAUGE											
20	28"	013356604	F, M, IC	3"	6 lbs. 9 oz.	45"	1 1/2"	2 3/8"	14 1/4"	1/4"	\$2,629.99
20	26"	013356605	F, M, IC	3"	6 lbs. 7 oz.	43"	1 1/2"	2 3/8"	14 1/4"	1/4"	2,629.99
28	28"	013356813	F, M, IC	2 3/4"	6 lbs. 13 oz.	45"	1 1/2"	2 3/8"	14 1/4"	1/4"	2,659.99
28	26"	013356814	F, M, IC	2 3/4"	6 lbs. 11 oz.	43"	1 1/2"	2 3/8"	14 1/4"	1/4"	2,659.99
.410	28"	013356913	F, M, IC	3"	6 lbs. 14 oz.	45"	1 1/2"	2 3/8"	14 1/4"	1/4"	2,659.99
.410	26"	013356914	F, M, IC	3"	6 lbs. 12 oz.	43"	1 1/2"	2 3/8"	14 1/4"	1/4"	2,659.99

*NOTE: Weights listed are approximate.



CITORI SUPERLIGHT FEATHER

GAUGE: 12, 20 (SHOWN) | GLOSS FINISH STOCK AND FOREARM

- RECEIVER** Lightweight alloy with steel breech face and hinge pin • High-relief engraving
- BARREL** Ventilated rib **ACTION** Single selective trigger • Hammer ejectors • Top-tang barrel selector/safety **STOCK** Gloss finish walnut • English-style straight grip stock
- Schnabel forearm **FEATURES** Vector Pro™ lengthened forcing cones
- Three Invector-Plus™ choke tubes • Ivory front bead sight

ENGINEERED FOR YEARS OF PERFORMANCE.

High-quality fit and finish make the Citori one of the most durable, longest-lasting guns you can own. When you open the breech of a Citori, the quality is evident. Precision manufacturing and hand-fitting ensures enduring quality and smooth operation. Timeless, elegant and exquisitely built, the Citori remains the quintessential over and under shotgun.



CITORI LIGHTNING FEATHER COMBO

GAUGE: 20, 28 | GLOSS FINISH STOCK AND FOREARM

- RECEIVER** Lightweight alloy with steel breech face and hinge pin
- High-relief engraving **BARRELS** Combo includes 3" chambered 20 gauge and 2¾" chambered 28 gauge barrels in 27" length • Ventilated rib
- ACTION** Single selective trigger • Hammer ejectors • Top-tang barrel selector/safety **STOCK** Gloss finish walnut • Lightning-style stock and forearm
- FEATURES** Vector Pro™ lengthened forcing cones on 20 gauge barrels • Three Invector-Plus™ 20 gauge choke tubes • Three Standard Invector™ 28 gauge choke tubes • Ivory front bead sight • Fitted luggage case included



CITORI 625 SPORTING, SMALL GAUGE

GAUGE: 20 (SHOWN), 28, .410 | GLOSS OIL FINISH STOCK AND FOREARM

- RECEIVER** Steel • Silver nitride finish • High-relief engraving with gold embellishment **BARRELS** Ventilated top and side rib • Tapered, floating top rib
- Ported on 20 **ACTION** Single selective trigger • Hammer ejectors • Top-tang barrel selector/safety **STOCK** Gloss oil finish Grade III/IV walnut stock with close radius pistol grip and right-hand palm swell • Schnabel forearm **FEATURES** Vector Pro™ lengthened forcing cones on 20 • Five Diamond Grade extended Invector-Plus™ choke tubes on 20 • Standard Invector™ on 28 and .410 • Sporting recoil pad
- Triple Trigger™ System • HiViz® Pro-Comp fiber-optic sight

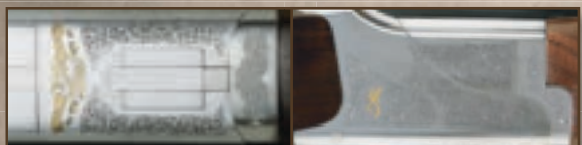

Citori 625 Sporting, Small Gauge, Bottom

Citori 625 Sporting, Small Gauge, Right



CITORI XS SPECIAL WITH LOW POST RIB AND ADJUSTABLE COMB

GAUGE: 12 | SATIN FINISH STOCK AND FOREARM

RECEIVER Steel • Silver nitride finish • Gold accented, high-relief XS Special engraving
BARREL Lightweight profile • Ventilated top and side ribs • Tapered, floating low post top rib • Ported
ACTION Single selective trigger • Hammer ejectors • Top-tang barrel selector/safety **STOCK** Satin finish walnut with right-hand palm swell • Adjustable comb • Semi-beavertail forearm with finger grooves
 • Ideal for skeet and sporting clays **FEATURES** Vector Pro™ lengthened forcing cones • Five Invector-Plus™ Midas™ Grade choke tubes • Triple Trigger™ System • HiViz® Pro-Comp fiber-optic sight



CITORI XS SPECIAL WITH HIGH POST RIB AND ADJUSTABLE COMB

GAUGE: 12 | SATIN FINISH STOCK AND FOREARM

RECEIVER Steel • Silver nitride finish • Gold accented, high-relief XS Special engraving
BARREL Lightweight profile • Ventilated top and side ribs • Tapered, floating high-post top rib • Ported
ACTION Single selective trigger • Hammer ejectors • Top-tang barrel selector/safety **STOCK** Satin finish walnut with right-hand palm swell • Adjustable comb • Semi-beavertail forearm with finger grooves
 • Ideal for skeet and sporting clays **FEATURES** Vector Pro™ lengthened forcing cones • Five Invector-Plus™ Midas™ Grade choke tubes • Triple Trigger™ System • HiViz® Pro-Comp fiber-optic sight

GA.	BARREL LENGTH	CODE NUMBER	CHOKES INCLUDED	CHAMBER	*AVG. WEIGHT	OVERALL LENGTH	DROP AT COMB	DROP AT HEEL	LENGTH OF PULL	TRIB WIDTH (TAPERED)	SUGG. RETAIL
CITORI SUPERLIGHT FEATHER											
12	26"	013055405	F, M, IC	2¾"	6 lbs. 4 oz.	43"	1⅞"	2½"	14¼"	¼"	\$2,389.99
20	26"	013055705	F, M, IC	2¾"	5 lbs. 11 oz.	43"	1½"	2⅝"	14¼"	⅜"	2,389.99
CITORI LIGHTNING FEATHER COMBO											
20 28	27"	013064735	F, M, IC	3" & 2¾"	6 lbs. 3 oz.	44"	1½"	2⅝"	14¼"	¼"	\$3,579.99
CITORI 625 SPORTING, SMALL GAUGE											
20	32"	013355726	F, IM, M, IC, SK	2¾"	7 lbs. 3 oz.	49½"	1⅞"	2⅝"	14¾"	⅜"	\$3,549.99
20	30"	013355727	F, IM, M, IC, SK	2¾"	7 lbs. 1 oz.	47½"	1⅞"	2⅝"	14¾"	⅜"	3,549.99
20	28"	013355728	F, IM, M, IC, SK	2¾"	6 lbs. 15 oz.	45½"	1⅞"	2⅝"	14¾"	⅜"	3,549.99
28	32"	013355811	F, IM, M, IC, SK	2¾"	7 lbs. 6 oz.	49½"	1⅞"	2⅝"	14¾"	⅜"	3,579.99
28	30"	013355812	F, IM, M, IC, SK	2¾"	7 lbs. 4 oz.	47½"	1⅞"	2⅝"	14¾"	⅜"	3,579.99
28	28"	013355813	F, IM, M, IC, SK	2¾"	7 lbs. 2 oz.	45½"	1⅞"	2⅝"	14¾"	⅜"	3,579.99
.410	32"	013355911	F, IM, M, IC, SK	3"	7 lbs. 7 oz.	49½"	1⅞"	2⅝"	14¾"	⅜"	3,579.99
.410	30"	013355912	F, IM, M, IC, SK	3"	7 lbs. 5 oz.	47½"	1⅞"	2⅝"	14¾"	⅜"	3,579.99
.410	28"	013355913	F, IM, M, IC, SK	3"	7 lbs. 3 oz.	45½"	1⅞"	2⅝"	14¾"	⅜"	3,579.99
CITORI XS SPECIAL WITH LOW POST RIB AND ADJUSTABLE COMB											
12	32"	013128426	IM, M, IC, SK, C	2¾"	8 lbs. 12 oz.	49¾"	1⅞" Adj.	1⅞" Adj.	14¾"	(⅝" - ⅞")	\$3,599.99
12	30"	013128427	IM, M, IC, SK, C	2¾"	8 lbs. 10 oz.	47¾"	1⅞" Adj.	1⅞" Adj.	14¾"	(⅝" - ⅞")	3,599.99
CITORI XS SPECIAL WITH HIGH POST RIB AND ADJUSTABLE COMB											
12	32"	013175426	IM, M, IC, SK, C	2¾"	8 lbs. 12 oz.	49¾"	1⅞" Adj.	1⅞" Adj.	14¾"	(⅝" - ⅞")	\$3,599.99
12	30"	013175427	IM, M, IC, SK, C	2¾"	8 lbs. 10 oz.	47¾"	1⅞" Adj.	1⅞" Adj.	14¾"	(⅝" - ⅞")	3,599.99

*NOTE: Weights listed are approximate.



CITORI XS SKEET GAUGE: 12 (SHOWN), 20 | SATIN FINISH STOCK AND FOREARM

RECEIVER Steel • Silver nitride finish • Gold accented, high-relief engraving **BARREL** Lightweight profile • Ventilated top and side ribs • Tapered, floating high post top rib • Ported **ACTION** Single selective trigger • Hammer ejectors • Top-tang barrel selector/safety **STOCK** Satin finish Grade III/IV walnut with right-hand palm swell • Semi-beavertail forearm with finger grooves **FEATURES** Vector Pro™ lengthened forcing cones • Three Invector-Plus™ choke tubes • Triple Trigger™ System • HiViz® Pro-Comp fiber-optic sight • Adjustable comb optional



CITORI XT TRAP GOLD WITH ADJUSTABLE COMB

GAUGE: 12 | GLOSS FINISH STOCK AND FOREARM

RECEIVER Steel • Silver nitride finish • Gold engraving of a game bird transforming into a clay target **BARREL** Ventilated top and side ribs • Tapered, floating high post top rib • Ported **ACTION** Single selective trigger • Hammer ejectors • Top-tang barrel selector/safety **STOCK** Gloss finish Grade V/VI walnut with right-hand palm swell • Semi-beavertail forearm with finger grooves **FEATURES** Vector Pro™ lengthened forcing cones • Three Invector-Plus™ choke tubes • Triple Trigger™ System • HiViz® Pro-Comp sight • Adjustable straight comb • Adjustable GraCoil® recoil reduction system



CITORI XT TRAP GAUGE: 12 | GLOSS FINISH STOCK AND FOREARM

RECEIVER Steel • Silver nitride finish • Gold accented, high-relief engraving **BARREL** Ventilated top and side ribs • Tapered, floating high post top rib • Ported **ACTION** Single selective trigger • Hammer ejectors • Top-tang barrel selector/safety **STOCK** Gloss finish Grade III/IV walnut with right-hand palm swell • Semi-beavertail forearm with finger grooves **FEATURES** Vector Pro™ lengthened forcing cones • Three Invector-Plus™ choke tubes • Triple Trigger™ System • HiViz® Pro-Comp sight • Adjustable straight comb optional

GA.	BARREL LENGTH	CODE NUMBER	CHOKES INCLUDED	CHAMBER	*AVG. WEIGHT	OVERALL LENGTH	DROP AT COMB	DROP AT HEEL	LENGTH OF PULL	RIB WIDTH (TAPERED)	SUGG. RETAIL
CITORI XS SKEET											
12	30"	013065427	SK, SK, IC	2¾"	7 lbs. 15 oz.	47½"	1¼"	1¼"	14¾"	¾"	\$3,189.99
12	28"	013065428	SK, SK, IC	2¾"	7 lbs. 13 oz.	45½"	1¼"	1¼"	14¾"	¾"	3,189.99
20	30"	013065727	SK, SK, IC	2¾"	7 lbs. 4 oz.	47½"	1¼"	1¼"	14¾"	¾"	3,189.99
20	28"	013065728	SK, SK, IC	2¾"	7 lbs. 2 oz.	45½"	1¼"	1¼"	14¾"	¾"	3,189.99
CITORI XS SKEET WITH ADJUSTABLE COMB (SHOWN)											
12	30"	013066427	SK, SK, IC	2¾"	8 lbs. 4 oz.	47½"	1⅞" Adj.	1⅞" Adj.	14¾"	¾"	\$3,599.99
12	28"	013066428	SK, SK, IC	2¾"	8 lbs. 2 oz.	45½"	1⅞" Adj.	1⅞" Adj.	14¾"	¾"	3,599.99
20	30"	013066727	SK, SK, IC	2¾"	7 lbs. 9 oz.	47½"	1⅞" Adj.	1⅞" Adj.	14¾"	¾"	3,599.99
20	28"	013066728	SK, SK, IC	2¾"	7 lbs. 7 oz.	45½"	1⅞" Adj.	1⅞" Adj.	14¾"	¾"	3,599.99
CITORI XT TRAP GOLD WITH ADJUSTABLE COMB											
12	32"	013228426	F, F, IM	2¾"	9 lbs. 2 oz.	49"	1⅞" Adj.	1⅞" Adj.	14¾"	(¼" - ¾")	\$5,719.99
12	30"	013228427	F, F, IM	2¾"	9 lbs.	47"	1⅞" Adj.	1⅞" Adj.	14¾"	(¼" - ¾")	5,719.99
CITORI XT TRAP (SHOWN)											
12	32"	013058426	F, F, IM	2¾"	8 lbs. 8 oz.	49"	1⅞"	2"	14¾"	(¼" - ¾")	\$2,959.99
12	30"	013058427	F, F, IM	2¾"	8 lbs. 6 oz.	47"	1⅞"	2"	14¾"	(¼" - ¾")	2,959.99
CITORI XT TRAP WITH ADJUSTABLE COMB											
12	32"	013057426	F, F, IM	2¾"	8 lbs. 13 oz.	49"	1⅞" Adj.	1⅞" Adj.	14¾"	(¼" - ¾")	\$3,389.99
12	30"	013057427	F, F, IM	2¾"	8 lbs. 11 oz.	47"	1⅞" Adj.	1⅞" Adj.	14¾"	(¼" - ¾")	3,389.99

*NOTE: Weights listed are approximate.





CITORI GRADE IV LIGHTNING GAUGE: 12 (SHOWN), 20, 28, .410 | GLOSS FINISH STOCK AND FOREARM

RECEIVER Steel • Grayed finish • Full coverage high-relief engraving includes the trigger guard and tang screws (12 gauge models illustrate pheasants on the right, mallards on the left. 20, 28 gauge and .410 bore models feature quail and grouse.)

BARREL Ventilated rib **ACTION** Single selective trigger • Hammer ejectors • Top-tang barrel selector/safety **STOCK** Gloss finish Grade III/IV walnut • Lightning-style stock and forearm **FEATURES** Vector Pro™ lengthened forcing cones on 12 and 20 • Three Invector-Plus™ choke tubes on 12 and 20 • Three Standard Invector™ on 28 and .410 • Recoil pad on 12 gauge model • Ivory front bead sight



Grade IV 12 Gauge, Left

Grade IV 12 Gauge, Right

Grade IV 20 & 28 Ga., .410, Left

Grade IV 20 & 28 Ga., .410, Right



CITORI GRADE VII LIGHTNING GAUGE: 12, 20 (SHOWN), 28, .410 | GLOSS FINISH STOCK AND FOREARM

RECEIVER Steel • Blued and grayed finishes available • Full coverage high-relief engraving is gold enhanced and includes the trigger guard, top-tang, forearm takedown lever and bracket (12 gauge models depict two flushing ringnecks and a pointer on the right side and three mallard drakes on the left side. 20, 28 gauge and .410 bore models feature quail and grouse.) **BARREL** Ventilated rib **ACTION** Single selective trigger • Hammer ejectors • Top-tang barrel selector/safety **STOCK** Gloss finish Grade V/VI walnut • Lightning-style stock and forearm **FEATURES** Vector Pro™ lengthened forcing cones on 12 and 20 • Three Invector-Plus™ choke tubes on 12 and 20 • Three Standard Invector™ on 28 and .410 • Recoil pad on 12 gauge model • Ivory front bead sight



Grade VII 12 Gauge, Grayed (Left)



Grade VII 12 Gauge, Grayed (Right)



Grade VII 20 & 28 Ga., .410, Grayed (Left)



Grade VII 20 & 28 Ga., .410, Grayed (Right)

GA.	BARREL LENGTH	CODE NUMBER	CHOKES INCLUDED	CHAMBER	*AVG. WEIGHT	OVERALL LENGTH	DROP AT COMB	DROP AT HEEL	LENGTH OF PULL	RIB WIDTH	SUGG. RETAIL	
CITORI GRADE IV LIGHTNING												
12	28"	013229304	F, M, IC	3"	8 lbs. 3 oz.	45"	1 1/8"	2 1/2"	14 1/4"	5/16"	\$3,499.99	
12	26"	013229305	F, M, IC	3"	8 lbs. 1 oz.	43"	1 1/8"	2 1/2"	14 1/4"	5/16"	3,499.99	
20	28"	013229604	F, M, IC	3"	6 lbs. 12 oz.	45"	1 1/2"	2 3/8"	14 1/4"	1/4"	3,499.99	
20	26"	013229605	F, M, IC	3"	6 lbs. 10 oz.	43"	1 1/2"	2 3/8"	14 1/4"	1/4"	3,499.99	
28	28"	013229813	F, M, IC	2 3/4"	6 lbs. 10 oz.	45"	1 1/2"	2 3/8"	14 1/4"	1/4"	3,589.99	
28	26"	013229814	F, M, IC	2 3/4"	6 lbs. 8 oz.	43"	1 1/2"	2 3/8"	14 1/4"	1/4"	3,589.99	
.410	28"	013229913	F, M, IC	3"	6 lbs. 10 oz.	45"	1 1/2"	2 3/8"	14 1/4"	1/4"	3,589.99	
.410	26"	013229914	F, M, IC	3"	6 lbs. 8 oz.	43"	1 1/2"	2 3/8"	14 1/4"	1/4"	3,589.99	
CITORI GRADE VII LIGHTNING												
Blued	12	28"	013302304	F, M, IC	3"	8 lbs. 3 oz.	45"	1 1/8"	2 1/2"	14 1/4"	5/16"	\$5,559.99
Blued	12	26"	013302305	F, M, IC	3"	8 lbs. 1 oz.	43"	1 1/8"	2 1/2"	14 1/4"	5/16"	5,559.99
Grayed	12	28"	013308304	F, M, IC	3"	8 lbs. 3 oz.	45"	1 1/8"	2 1/2"	14 1/4"	5/16"	5,559.99
Grayed	12	26"	013308305	F, M, IC	3"	8 lbs. 1 oz.	43"	1 1/8"	2 1/2"	14 1/4"	5/16"	5,559.99
Blued	20	28"	013302604	F, M, IC	3"	6 lbs. 12 oz.	45"	1 1/2"	2 3/8"	14 1/4"	1/4"	5,559.99
Blued	20	26"	013302605	F, M, IC	3"	6 lbs. 10 oz.	43"	1 1/2"	2 3/8"	14 1/4"	1/4"	5,559.99
Grayed	20	28"	013308604	F, M, IC	3"	6 lbs. 12 oz.	45"	1 1/2"	2 3/8"	14 1/4"	1/4"	5,559.99
Grayed	20	26"	013308605	F, M, IC	3"	6 lbs. 10 oz.	43"	1 1/2"	2 3/8"	14 1/4"	1/4"	5,559.99
Blued	28	28"	013302813	F, M, IC	2 3/4"	6 lbs. 9 oz.	45"	1 1/2"	2 3/8"	14 1/4"	1/4"	5,659.99
Blued	28	26"	013302814	F, M, IC	2 3/4"	6 lbs. 7 oz.	43"	1 1/2"	2 3/8"	14 1/4"	1/4"	5,659.99
Grayed	28	28"	013308813	F, M, IC	2 3/4"	6 lbs. 9 oz.	45"	1 1/2"	2 3/8"	14 1/4"	1/4"	5,659.99
Grayed	28	26"	013308814	F, M, IC	2 3/4"	6 lbs. 7 oz.	43"	1 1/2"	2 3/8"	14 1/4"	1/4"	5,659.99
Blued	.410	28"	013302913	F, M, IC	3"	6 lbs. 10 oz.	45"	1 1/2"	2 3/8"	14 1/4"	1/4"	5,659.99
Blued	.410	26"	013302914	F, M, IC	3"	6 lbs. 8 oz.	43"	1 1/2"	2 3/8"	14 1/4"	1/4"	5,659.99
Grayed	.410	28"	013308913	F, M, IC	3"	6 lbs. 10 oz.	45"	1 1/2"	2 3/8"	14 1/4"	1/4"	5,659.99
Grayed	.410	26"	013308914	F, M, IC	3"	6 lbs. 8 oz.	43"	1 1/2"	2 3/8"	14 1/4"	1/4"	5,659.99

*NOTE: Weights listed are approximate.



TRULY INNOVATIVE.

Even on the rack, a Browning Cynergy sets itself apart from other over and under shotguns. Open the breech and you'll know why. The low-profile

Cynergy is a new experience in over and under shotguns with performance, recoil control, speed and reliability that you must shoot to fully appreciate.

REVERSE STRIKER MECHANICAL TRIGGER

The Cynergy features the innovative Reverse Striker ignition system; a striker-based, mechanical trigger that offers the benefits of a crisp feel, reduced locktime and less overtravel than other over and under shotguns. Because inertia is not needed for the hammers to set, the design eliminates the possibility of the second barrel not firing. Cynergy target models are equipped with the Triple Trigger™ System, allowing you to adjust the length of pull and switch between styles of trigger shoes: Wide checkered, narrow smooth or wide smooth canted.

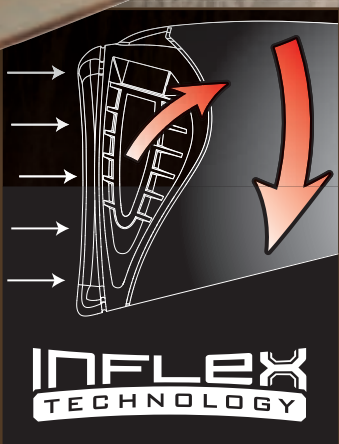
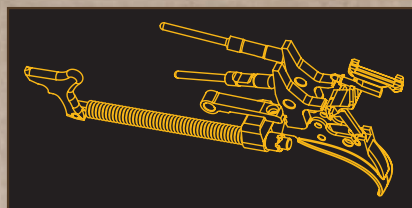

INFLEX TECHNOLOGY RECOIL PAD

The Inflex Technology recoil pad system provides long travel recoil reduction for a massive 25% decrease in felt recoil on 12 gauge guns and makes recoil virtually non-existent on small gauge guns. A slick Parylene coating prevents the pad from snagging on clothing and allows the recoil pad to remain soft. Three pad lengths are available in 1/2" increments to provide length of pull adjustment to fit a wide variety of shooters. A 1/4" spacer is included for customizing. See page 29 for accessories. (Inflex Technology pad not available on Cynergy Classics.)



VECTOR**PRO**



Cynergy Field, Left



Cynergy Field, Right

CYNERGY FIELD

GAUGE: 12 (SHOWN), 20, 28, .410 | GLOSS OIL FINISH STOCK AND FOREARM

RECEIVER Steel • Silver nitride finish • Ultra-low profile • MonoLock Hinge • Jewelled monobloc • High-relief engraving on the receiver, forearm iron and top lever (12 gauge models illustrate pheasants and ducks. Small gauge models feature quail and grouse.) **BARREL** Lightweight profile • Ventilated top and side ribs **ACTION** Reverse Striker ignition system • Impact Ejectors • Top-tang barrel selector/safety **STOCK** Gloss oil finish and upgraded Grade II/III walnut **FEATURES** Vector Pro™ lengthened forcing cones on 12 and 20 • Three Invector-Plus™ choke tubes on 12 and 20 • Three Standard Invector™ on 28 and .410 • Inflex Technology recoil pad system • ¼" stock spacer • Ivory front and mid-bead sights

GA.	BARREL LENGTH	CODE NUMBER	CHOKES INCLUDED	CHAMBER	*AVG. WEIGHT	OVERALL LENGTH	DROP AT COMB	DROP AT HEEL	LENGTH OF PULL	TRIB WIDTH	SUGG. RETAIL
12	28"	013297304	F, M, IC	3"	7 lbs. 11 oz.	45"	1¼"	2½"	14¼"	⅝"	\$2,799.99
12	26"	013297305	F, M, IC	3"	7 lbs. 9 oz.	43"	1¼"	2½"	14¼"	⅝"	2,799.99
20	28"	013297604	F, M, IC	3"	6 lbs. 4 oz.	45"	1½"	2⅝"	14¼"	⅞"	2,859.99
20	26"	013297605	F, M, IC	3"	6 lbs. 2 oz.	43"	1½"	2⅝"	14¼"	⅞"	2,859.99
28	28"	013297813	F, M, IC	2¾"	6 lbs. 4 oz.	45"	1½"	2⅝"	14¼"	⅞"	2,859.99
28	26"	013297814	F, M, IC	2¾"	6 lbs. 2 oz.	43"	1½"	2⅝"	14¼"	⅞"	2,859.99
.410	28"	013297913	F, M, IC	3"	6 lbs. 1 oz.	45"	1½"	2⅝"	14¼"	⅞"	2,859.99
.410	26"	013297914	F, M, IC	3"	5 lbs. 15 oz.	43"	1½"	2⅝"	14¼"	⅞"	2,859.99

*NOTE: Weights listed are approximate.

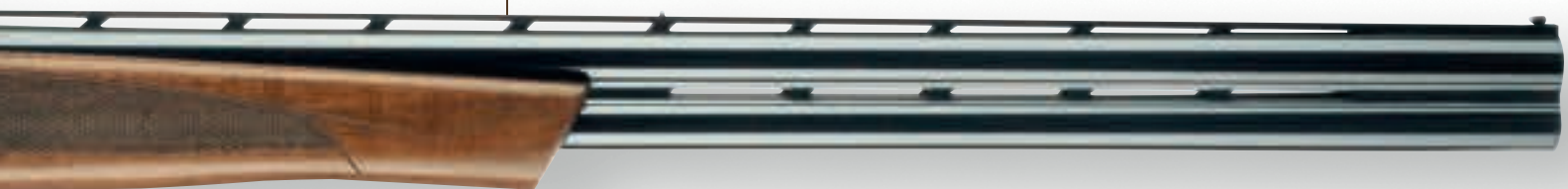

VECTOR PRO™ LENGTHENED FORCING CONES ON 12 AND 20 GAUGE CYNERGY SHOTGUNS

We were the first manufacturer to recognize the performance advantages of a back-bored barrel and to make it a standard feature on our shotguns. Now we have gone a step further with our Vector Pro lengthened forcing cone. Longer, tapered Vector Pro dimensions minimize shot deformation and maximize pattern uniformity, consistency and density. Back-boring increases bore diameter specifications and decreases friction between the shot cup and the bore to maximize shot pellet velocity and to reduce felt recoil. Reducing constriction from the forcing cone on the shot column results in fewer deformed pellets for more uniform patterns, and keeps more pellets in the central part of the pattern where they're needed to bag more upland birds, waterfowl and clay targets. A larger bore diameter can let gases slip by the shot cup, resulting in both reduced pellet velocity and blown patterns. A smaller bore diameter means the forcing cone can deform pellets, leading to flyers and poor ballistic performance. Our back-bore specifications represent the ideal bore dimensions.



MONOLOCK HINGE

The strong MonoLock Hinge design is the engineering behind the Cynergy's low profile receiver. The MonoLock Hinge is the integration of the monobloc and the hinge, and has up to 300% more surface area to pivot on than traditional trunnion-style hinges. Rectangular locking pins provide extra strength and feature a "Wear-In Relief" that keeps the action tight. Jeweling adds a beautiful appearance, smoother function and improves durability.

VECTOR**PRO**



CHROME CHAMBERS

For increased durability and corrosion resistance, all Cynergy shotguns feature hard chrome-plated chambers to resist the toll that thousands of shells can take on lesser quality guns.

STEEL SHOT PERFORMANCE

The strength of Browning barrels is legendary, and built to handle the punishment of steel shot. Unlike some manufacturers' barrels that show pitting after shooting steel, we have pioneered construction that maximizes steel shot performance and barrel durability. Our barrels meet the strictest material and construction quality standards. The barrel blanks are made from rolled and tempered steel bars and are stress relieved to offer exceptional mechanical properties. The barrel blanks are then precision drilled, reamed and honed to exacting specifications. With proper care, Browning Cynergy barrels will last a lifetime.





CYNERGY FEATHER GAUGE: 12 (SHOWN), 20, 28, .410 | GLOSS OIL FINISH STOCK AND FOREARM

RECEIVER Lightweight alloy with steel breech face • Gold enhanced grayed finish • Ultra-low profile • MonoLock Hinge • Jewelled monobloc
BARREL Lightweight profile • Ventilated top and side ribs

ACTION Reverse Striker ignition system • Impact Ejectors • Top-tang barrel selector/safety

STOCK Gloss oil finish and upgraded Grade II/III walnut **FEATURES** Vector Pro™ lengthened forcing cones on 12 and 20 • Three Invector-Plus™ choke tubes on 12 and 20 • Three Standard Invector™ on 28 and .410 • Inflex Technology recoil pad system • ¼" stock spacer • Ivory front and mid-bead sights

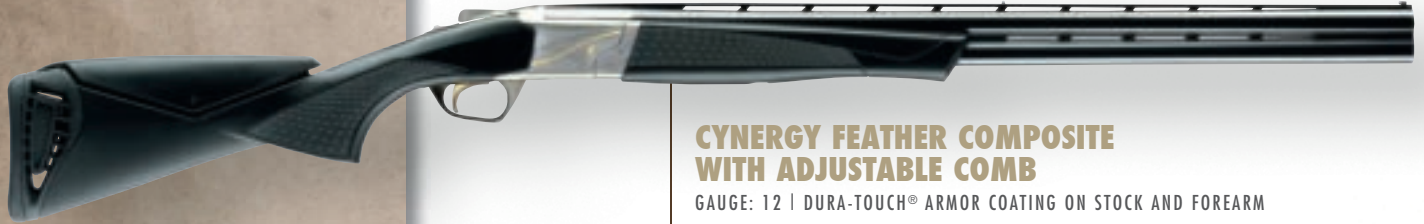

CYNERGY FEATHER COMPOSITE WITH ADJUSTABLE COMB

GAUGE: 12 | DURA-TOUCH® ARMOR COATING ON STOCK AND FOREARM

RECEIVER Lightweight alloy with steel breech face • Gold enhanced grayed finish • Ultra-low profile • MonoLock Hinge • Jewelled monobloc

BARREL Lightweight profile • Ventilated top and side ribs **ACTION** Reverse Striker ignition system • Impact Ejectors • Top-tang barrel selector/safety

STOCK Black composite with rubber overmoldings in grip areas • Dura-Touch® Armor Coating • Adjustable comb **FEATURES** Vector Pro™ lengthened forcing cones • Three Invector-Plus™ choke tubes • Inflex Technology recoil pad system • ¼" stock spacer • Ivory front and mid-bead sights

DURA-TOUCH®
Armor Coating

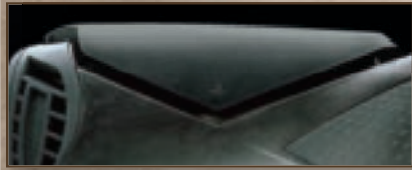

ADJUSTABLE COMB

Composite models include an integrated, adjustable comb system that allows the gun to be easily customized to your individual needs. Drop at comb adjustments are made in 1/8" increments. For cast on/cast off customizing, accessory combs are available on page 29.



SUPERIOR GRIPPING SURFACES

Composite Cynergy models combine molded-in rubberized textured gripping surfaces and our proven Dura-Touch® Armor Coating for a sure hold and a sleek feel in all climates and weather conditions.

GA.	BARREL LENGTH	CODE NUMBER	CHOKES INCLUDED	CHAMBER	*AVG. WEIGHT	OVERALL LENGTH	DROP AT COMB	DROP AT HEEL	LENGTH OF PULL	TRIB WIDTH	SUGG. RETAIL
CYNERGY FEATHER											
12	28"	013293304	F, M, IC	3"	6 lbs. 11 oz.	45"	1 1/8"	2 1/2"	14 1/4"	5/16"	\$2,899.99
12	26"	013293305	F, M, IC	3"	6 lbs. 13 oz.	43"	1 1/8"	2 1/2"	14 1/4"	5/16"	2,899.99
20	28"	013293604	F, M, IC	3"	5 lbs. 10 oz.	45"	1 1/2"	2 3/8"	14 1/4"	7/32"	2,919.99
20	26"	013293605	F, M, IC	3"	5 lbs. 8 oz.	43"	1 1/2"	2 3/8"	14 1/4"	7/32"	2,919.99
28	28"	013293813	F, M, IC	2 3/4"	5 lbs. 15 oz.	45"	1 1/2"	2 3/8"	14 1/4"	7/32"	2,919.99
28	26"	013293814	F, M, IC	2 3/4"	5 lbs. 15 oz.	43"	1 1/2"	2 3/8"	14 1/4"	7/32"	2,919.99
.410	28"	013293913	F, M, IC	3"	6 lbs.	45"	1 1/2"	2 3/8"	14 1/4"	7/32"	2,919.99
.410	26"	013293914	F, M, IC	3"	6 lbs.	43"	1 1/2"	2 3/8"	14 1/4"	7/32"	2,919.99

CYNERGY FEATHER COMPOSITE WITH ADJUSTABLE COMB											
12	28"	013275304	F, M, IC	3"	6 lbs. 9 oz.	45"	1 1/8" Adj.	2 1/2" Adj.	14 1/4"	5/16"	\$2,799.99
12	26"	013275305	F, M, IC	3"	6 lbs. 7 oz.	43"	1 1/8" Adj.	2 1/2" Adj.	14 1/4"	5/16"	2,799.99

*NOTE: Weights listed are approximate.

VECTORPRO®



BACK-BORED TECHNOLOGY



CYNERGY SPORTING GAUGE: 12 (SHOWN), 20 | GLOSS OIL FINISH STOCK AND FOREARM

RECEIVER Steel • Silver nitride finish • Ultra-low profile • MonoLock Hinge • Jewelled monobloc • High-relief scroll engraving on receiver, forearm iron and top lever **BARREL** Lightweight profile • Ventilated top and side ribs • Ported **ACTION** Reverse Striker ignition system • Impact Ejectors • Top-tang barrel selector/safety **STOCK** Gloss oil finish Grade III/IV walnut **FEATURES** Vector Pro™ lengthened forcing cones • Three Invector-Plus™ Diana™ Grade choke tubes • Inflex Technology recoil pad system • Triple Trigger™ System • HiViz® Pro-Comp fiber-optic sight • ¼" stock spacer



CYNERGY SPORTING WITH ADJUSTABLE COMB

GAUGE: 12 | GLOSS OIL FINISH STOCK AND FOREARM

RECEIVER Steel • Silver nitride finish • Ultra-low profile • MonoLock Hinge • Jewelled monobloc • High-relief scroll engraving on receiver, forearm iron and top lever **BARREL** Lightweight profile • Ventilated top and side ribs • Ported **ACTION** Reverse Striker ignition system • Impact Ejectors • Top-tang barrel selector/safety **STOCK** Gloss oil finish Grade III/IV walnut • Comb adjustment for cast and drop **FEATURES** Vector Pro™ lengthened forcing cones • Three Invector-Plus™ Diana™ Grade choke tubes • Inflex Technology recoil pad system • Triple Trigger™ System • HiViz® Pro-Comp fiber-optic sight • ¼" stock spacer

CYNERGY

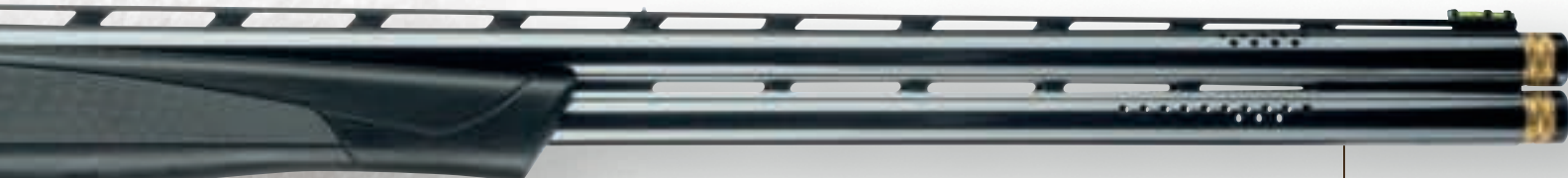

CYNERGY SPORTING COMPOSITE WITH ADJUSTABLE COMB

GAUGE: 12 | DURA-TOUCH[®] ARMOR COATING ON STOCK AND FOREARM



RECEIVER Steel • Silver nitride finish • Ultra-low profile • MonoLock Hinge • Jewelled monobloc • High-relief scroll engraving on receiver, forearm iron and top lever **BARREL** Lightweight profile • Ventilated top and side ribs • Ported **ACTION** Reverse Striker ignition system • Impact Ejectors • Top-tang barrel selector/safety **STOCK** Black composite with rubber overmoldings in grip areas • Dura-Touch[®] Armor Coating • Adjustable comb **FEATURES** Vector Pro™ lengthened forcing cones • Three Invector-Plus™ Diana™ Grade choke tubes • Inflex Technology recoil pad system • Triple Trigger™ System • HiViz® Pro-Comp fiber-optic sight • ¼" stock spacer



GA.	BARREL LENGTH	CODE NUMBER	CHOKES INCLUDED	CHAMBER	*AVG. WEIGHT	OVERALL LENGTH	DROP AT COMB	DROP AT HEEL	LENGTH OF PULL	RIB WIDTH (TAPERED)	SUGG. RETAIL
CYNERGY SPORTING											
12	32"	013294326	M, IC, SK	3"	8 lbs. 1 oz.	50"	1 ¹ / ₁₆ "	2 ³ / ₁₆ "	14 ¹ / ₄ "	(³ / ₁₆ " - ⁷ / ₁₆ "	\$4,019.99
12	30"	013294327	M, IC, SK	3"	7 lbs. 15 oz.	48"	1 ¹ / ₁₆ "	2 ³ / ₁₆ "	14 ¹ / ₄ "	(³ / ₁₆ " - ⁷ / ₁₆ "	4,019.99
12	28"	013294328	M, IC, SK	3"	7 lbs. 13 oz.	46"	1 ¹ / ₁₆ "	2 ³ / ₁₆ "	14 ¹ / ₄ "	(³ / ₁₆ " - ⁷ / ₁₆ "	4,019.99
20	32"	013294626	M, IC, SK	3"	6 lbs. 8 oz.	50"	1 ¹ / ₁₆ "	2 ³ / ₁₆ "	14 ¹ / ₄ "	¼"	4,039.99
20	30"	013294627	M, IC, SK	3"	6 lbs. 6 oz.	48"	1 ¹ / ₁₆ "	2 ³ / ₁₆ "	14 ¹ / ₄ "	¼"	4,039.99
20	28"	013294628	M, IC, SK	3"	6 lbs. 4 oz.	46"	1 ¹ / ₁₆ "	2 ³ / ₁₆ "	14 ¹ / ₄ "	¼"	4,039.99
CYNERGY SPORTING WITH ADJUSTABLE COMB											
12	32"	013295326	M, IC, SK	3"	8 lbs. 7 oz.	50"	1 ⁵ / ₁₆ "	2 ⁷ / ₁₆ " Adj.	14 ¹ / ₄ "	(³ / ₁₆ " - ⁷ / ₁₆ "	\$4,499.99
12	30"	013295327	M, IC, SK	3"	8 lbs. 5 oz.	48"	1 ⁵ / ₁₆ "	2 ⁷ / ₁₆ " Adj.	14 ¹ / ₄ "	(³ / ₁₆ " - ⁷ / ₁₆ "	4,499.99
12	28"	013295328	M, IC, SK	3"	8 lbs. 3 oz.	46"	1 ⁵ / ₁₆ "	2 ⁷ / ₁₆ " Adj.	14 ¹ / ₄ "	(³ / ₁₆ " - ⁷ / ₁₆ "	4,499.99
CYNERGY SPORTING COMPOSITE WITH ADJUSTABLE COMB											
12	32"	013296326	M, IC, SK	3"	7 lbs. 13 oz.	50"	1 ¹ / ₁₆ " Adj.	2 ³ / ₁₆ " Adj.	14 ¹ / ₄ "	(³ / ₁₆ " - ⁷ / ₁₆ "	\$3,869.99
12	30"	013296327	M, IC, SK	3"	7 lbs. 11 oz.	48"	1 ¹ / ₁₆ " Adj.	2 ³ / ₁₆ " Adj.	14 ¹ / ₄ "	(³ / ₁₆ " - ⁷ / ₁₆ "	3,869.99
12	28"	013296328	M, IC, SK	3"	7 lbs. 9 oz.	46"	1 ¹ / ₁₆ " Adj.	2 ³ / ₁₆ " Adj.	14 ¹ / ₄ "	(³ / ₁₆ " - ⁷ / ₁₆ "	3,869.99

*NOTE: Weights listed are approximate.



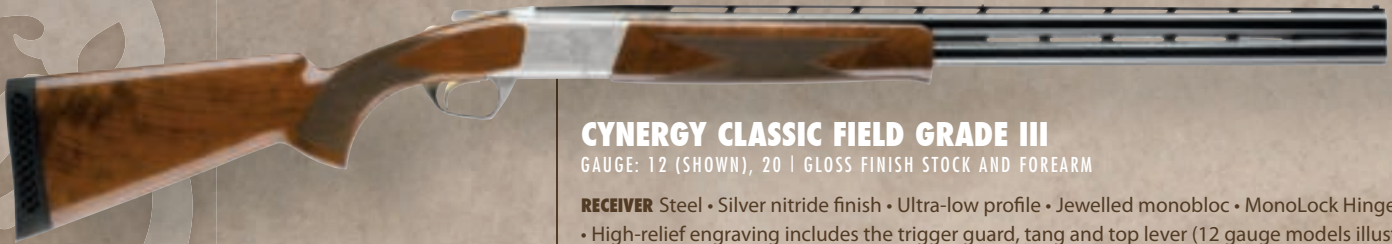

CYNERGY CLASSIC FIELD GRADE III

GAUGE: 12 (SHOWN), 20 | GLOSS FINISH STOCK AND FOREARM

- RECEIVER** Steel • Silver nitride finish • Ultra-low profile • Jewelled monobloc • MonoLock Hinge • High-relief engraving includes the trigger guard, tang and top lever (12 gauge models illustrate pheasants on the left, mallards on the right. 20 gauge models feature teal and partridge.)
- BARREL** Lightweight profile • Ventilated top and side ribs **ACTION** Reverse Striker ignition system • Impact Ejectors • Top-tang barrel selector/safety
- STOCK** Gloss finish Grade III/IV walnut
- FEATURES** Vector Pro™ lengthened forcing cones • Three Invector-Plus™ choke tubes • Ivory front and mid-bead sights • Recoil pad on 12 gauge model



Cynergy Classic Field Gr. III
12 Gauge, Bottom

Cynergy Classic Field Gr. III
12 Gauge, Left

Cynergy Classic Field Gr. III
12 Gauge, Right

Cynergy Classic Field Gr. III
20 Gauge, Bottom

Cynergy Classic Field Gr. III
20 Gauge, Left

Cynergy Classic Field Gr. III
20 Gauge, Right



CYNERGY CLASSIC FIELD GRADE VI

GAUGE: 12 (SHOWN), 20 | GLOSS FINISH STOCK AND FOREARM

- RECEIVER** Steel • Silver nitride finish • Ultra-low profile • Jewelled monobloc • MonoLock Hinge • Full coverage high-relief engraving is gold enhanced and includes the trigger guard, tang and top lever (12 gauge models illustrate pheasants on the right, mallards on the left. 20 gauge models feature quail and grouse.)
- BARREL** Lightweight profile • Ventilated top and side ribs
- ACTION** Reverse Striker ignition system • Impact Ejectors • Top-tang barrel selector/safety
- STOCK** Gloss finish Grade V/VI walnut
- FEATURES** Vector Pro™ lengthened forcing cones • Three Invector-Plus™ choke tubes • Ivory front and mid-bead sights • Recoil pad on 12 gauge model

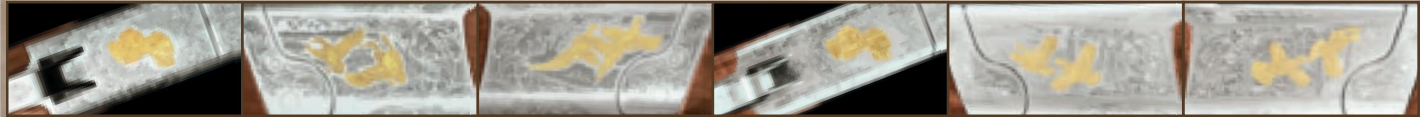

Cynergy Classic Field Gr. VI
12 Gauge, Bottom

Cynergy Classic Field Gr. VI
12 Gauge, Left

Cynergy Classic Field Gr. VI
12 Gauge, Right

Cynergy Classic Field Gr. VI
20 Gauge, Bottom

Cynergy Classic Field Gr. VI
20 Gauge, Left

Cynergy Classic Field Gr. VI
20 Gauge, Right



GA.	BARREL LENGTH	CODE NUMBER	CHOKES INCLUDED	CHAMBER	*AVG. WEIGHT	OVERALL LENGTH	DROP AT COMB	DROP AT HEEL	LENGTH OF PULL	TRIB WIDTH	SUGG. RETAIL
CYNERGY CLASSIC FIELD GRADE III											
12	28"	013252304	F, M, IC	3"	8 lbs. 1 oz.	45"	1 3/8"	2 1/2"	14 1/4"	3/16"	\$3,999.99
12	26"	013252305	F, M, IC	3"	7 lbs. 15 oz.	43"	1 3/8"	2 1/2"	14 1/4"	3/16"	3,999.99
20	28"	013252604	F, M, IC	3"	6 lbs. 10 oz.	45"	1 1/2"	2 3/8"	14 1/4"	7/32"	4,059.99
20	26"	013252605	F, M, IC	3"	6 lbs. 8 oz.	43"	1 1/2"	2 3/8"	14 1/4"	7/32"	4,059.99
CYNERGY CLASSIC FIELD GRADE VI											
12	28"	013253304	F, M, IC	3"	8 lbs. 1 oz.	45"	1 3/8"	2 1/2"	14 1/4"	3/16"	\$6,099.99
12	26"	013253305	F, M, IC	3"	7 lbs. 15 oz.	43"	1 3/8"	2 1/2"	14 1/4"	3/16"	6,099.99
20	28"	013253604	F, M, IC	3"	6 lbs. 10 oz.	45"	1 1/2"	2 3/8"	14 1/4"	7/32"	6,119.99
20	26"	013253605	F, M, IC	3"	6 lbs. 8 oz.	43"	1 1/2"	2 3/8"	14 1/4"	7/32"	6,119.99

*NOTE: Weights listed are approximate.



IMPACT EJECTORS

Impact Ejectors are aided by the punch of a secondary striker spring for more positive, reliable ejection of fired hulls from the chambers. Unfired shells are elevated for easy removal.



CYNERGY CLASSIC FIELD GAUGE: 12 (SHOWN), 20, 28, .410 | GLOSS OIL FINISH STOCK AND FOREARM

RECEIVER Steel • Silver nitride finish • Ultra-low profile • Jewelled monobloc • MonoLock Hinge • High-relief engraving (12 gauge models illustrate pheasants on the left, mallards on the right. Small gauge models feature quail and grouse.) **BARREL** Lightweight profile • Ventilated top and side ribs **ACTION** Reverse Striker ignition system • Impact Ejectors • Top-tang barrel selector/safety **STOCK** Gloss oil finish and upgraded Grade II/III walnut **FEATURES** Vector Pro™ lengthened forcing cones on 12 and 20 • Three Invector-Plus™ choke tubes on 12 and 20 • Three Standard Invector™ on 28 and .410 • Ivory front and mid-bead sights • Recoil pad on 12 gauge model



Cynergy Classic Field 12 Gauge, Left



Cynergy Classic Field 12 Gauge, Right



Cynergy Classic Field 12 Gauge, Bottom



CYNERGY CLASSIC SPORTING

GAUGE: 12 (SHOWN), 20, 28, .410 | GLOSS OIL FINISH STOCK AND FOREARM

RECEIVER Steel • Silver nitride finish • Ultra-low profile • Jewelled monobloc • MonoLock Hinge **BARREL** Lightweight profile • Ventilated top and side ribs • Ported **ACTION** Reverse Striker ignition system • Impact Ejectors • Top-tang barrel selector/safety **STOCK** Gloss oil finish Grade III/IV walnut **FEATURES** Vector Pro™ lengthened forcing cones on 12 and 20 • Three Invector-Plus™ Midas™ Grade choke tubes on 12 and 20 • Three Standard Invector™ on 28 and .410 • Triple Trigger™ System • HiViz® Pro-Comp fiber-optic sight



Cynergy Classic Sporting, Right



Cynergy Classic Sporting, Bottom



GA.	BARREL LENGTH	CODE NUMBER	CHOKES INCLUDED	CHAMBER	*AVG. WEIGHT	OVERALL LENGTH	DROP AT COMB	DROP AT HEEL	LENGTH OF PULL	RIB WIDTH (TAPERED)	SUGG. RETAIL
CYNERGY CLASSIC FIELD											
12	28"	013702304	F, M, IC	3"	7 lbs. 13 oz.	45"	1 5/8"	2 1/2"	14 1/4"	5/16"	\$2,539.99
12	26"	013702305	F, M, IC	3"	7 lbs. 11 oz.	43"	1 5/8"	2 1/2"	14 1/4"	5/16"	2,539.99
20	28"	013702604	F, M, IC	3"	6 lbs. 6 oz.	45"	1 1/2"	2 3/8"	14 1/4"	7/32"	2,589.99
20	26"	013702605	F, M, IC	3"	6 lbs. 4 oz.	43"	1 1/2"	2 3/8"	14 1/4"	7/32"	2,589.99
28	28"	013702813	F, M, IC	2 3/4"	6 lbs. 9 oz.	45"	1 1/2"	2 3/8"	14 1/4"	7/32"	2,589.99
28	26"	013702814	F, M, IC	2 3/4"	6 lbs. 7 oz.	43"	1 1/2"	2 3/8"	14 1/4"	7/32"	2,589.99
.410	28"	013702913	F, M, IC	3"	6 lbs. 6 oz.	45"	1 1/2"	2 3/8"	14 1/4"	7/32"	2,589.99
.410	26"	013702914	F, M, IC	3"	6 lbs. 4 oz.	43"	1 1/2"	2 3/8"	14 1/4"	7/32"	2,589.99
CYNERGY CLASSIC SPORTING											
12	32"	013703326	M, IC, SK	3"	7 lbs. 15 oz.	50"	1 1/8"	2 3/8"	14 3/4"	(5/16" - 7/16")	\$3,599.99
12	30"	013703327	M, IC, SK	3"	7 lbs. 13 oz.	48"	1 1/8"	2 3/8"	14 3/4"	(5/16" - 7/16")	3,599.99
12	28"	013703328	M, IC, SK	3"	7 lbs. 11 oz.	46"	1 1/8"	2 3/8"	14 3/4"	(5/16" - 7/16")	3,599.99
20	32"	013703626	M, IC, SK	3"	6 lbs. 8 oz.	50"	1 1/8"	2 3/8"	14 3/4"	1/4"	3,639.99
20	30"	013703627	M, IC, SK	3"	6 lbs. 6 oz.	48"	1 1/8"	2 3/8"	14 3/4"	1/4"	3,639.99
20	28"	013703628	M, IC, SK	3"	6 lbs. 4 oz.	46"	1 1/8"	2 3/8"	14 3/4"	1/4"	3,639.99
28	30"	013703812	M, IC, SK	2 3/4"	6 lbs. 9 oz.	48"	1 1/8"	2 3/8"	14 3/4"	1/4"	3,639.99
28	28"	013703813	M, IC, SK	2 3/4"	6 lbs. 7 oz.	46"	1 1/8"	2 3/8"	14 3/4"	1/4"	3,639.99
.410	30"	013703912	M, IC, SK	3"	6 lbs. 6 oz.	48"	1 1/8"	2 3/8"	14 3/4"	1/4"	3,639.99
.410	28"	013703913	M, IC, SK	3"	6 lbs. 4 oz.	46"	1 1/8"	2 3/8"	14 3/4"	1/4"	3,639.99

*NOTE: Weights listed are approximate.



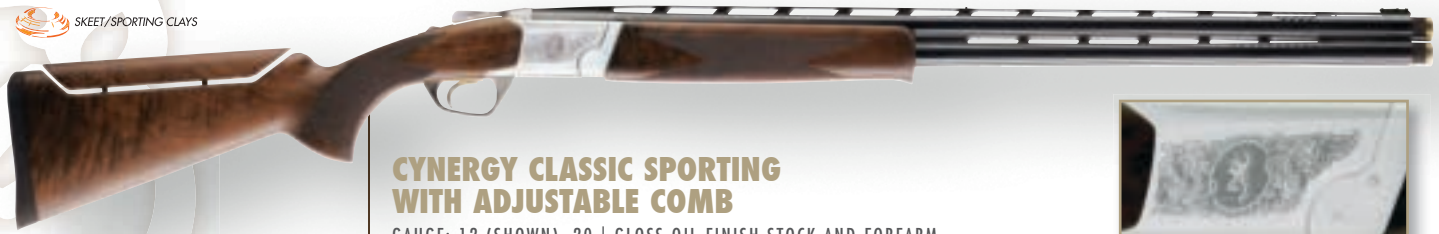

CYNERGY CLASSIC SPORTING WITH ADJUSTABLE COMB

GAUGE: 12 (SHOWN), 20 | GLOSS OIL FINISH STOCK AND FOREARM

RECEIVER Steel • Silver nitride finish • Ultra-low profile • Jewelled monobloc • MonoLock Hinge **BARREL** Lightweight profile • Ventilated top and side ribs • Ported **ACTION** Reverse Striker ignition system • Impact Ejectors • Top-tang barrel selector/safety **STOCK** Grade III/IV gloss oil finish walnut **FEATURES** Vector Pro™ lengthened forcing cones • Three Invector-Plus™ Midas™ Grade choke tubes • Triple Trigger™ System • HiViz® Pro-Comp fiber-optic sight



Cynergy Classic Sporting, Right



Cynergy Classic Sporting, Bottom



CYNERGY CLASSIC TRAP GAUGE: 12 | GLOSS FINISH STOCK AND FOREARM

RECEIVER Steel • Silver nitride finish • Ultra-low profile • Jewelled monobloc • MonoLock Hinge **BARREL** Lightweight profile • Tapered floating top rib • Ported **ACTION** Reverse Striker ignition system • Impact Ejectors • Top-tang barrel selector/safety **STOCK** Gloss finish Monte Carlo Grade III/IV walnut stock with right-hand palm swell • Modified semi-beavertail forearm with finger grooves **FEATURES** Vector Pro™ lengthened forcing cones • Three Invector-Plus™ Midas™ Grade choke tubes • Triple Trigger™ System • HiViz® Pro-Comp fiber-optic sight



CYNERGY CLASSIC TRAP WITH ADJUSTABLE COMB

GAUGE: 12 | GLOSS FINISH STOCK AND FOREARM

RECEIVER Steel • Silver nitride finish • Ultra-low profile • Jewelled monobloc • MonoLock Hinge **BARREL** Lightweight profile • Tapered floating top rib • Ported **ACTION** Reverse Striker ignition system • Impact Ejectors • Top-tang barrel selector/safety **STOCK** Gloss finish Monte Carlo Grade III/IV walnut stock with right-hand palm swell • Modified semi-beavertail forearm with finger grooves **FEATURES** Vector Pro™ lengthened forcing cones • Three Invector-Plus™ Midas™ Grade choke tubes • Triple Trigger™ System • HiViz® Pro-Comp fiber-optic sight

GA.	BARREL LENGTH	CODE NUMBER	CHOKES INCLUDED	CHAMBER	*AVG. WEIGHT	OVERALL LENGTH	DROP AT COMB	DROP AT HEEL	LENGTH OF PULL	RIB WIDTH (TAPERED)	SUGG. RETAIL
CYNERGY CLASSIC SPORTING WITH ADJUSTABLE COMB											
12	32"	013704326	M, IC, SK	3"	8 lbs. 11 oz.	50"	1¾" Adj.	2½" Adj.	14¾"	(⅜" - ⅞")	\$3,999.99
12	30"	013704327	M, IC, SK	3"	8 lbs. 9 oz.	48"	1¾" Adj.	2½" Adj.	14¾"	(⅜" - ⅞")	3,999.99
12	28"	013704328	M, IC, SK	3"	8 lbs. 7 oz.	46"	1¾" Adj.	2½" Adj.	14¾"	(⅜" - ⅞")	3,999.99
20	32"	013704626	M, IC, SK	3"	7 lbs. 4 oz.	50"	1⅝" Adj.	2⅝" Adj.	14¾"	¼"	4,039.99
20	30"	013704627	M, IC, SK	3"	7 lbs. 2 oz.	48"	1⅝" Adj.	2⅝" Adj.	14¾"	¼"	4,039.99
20	28"	013704628	M, IC, SK	3"	7 lbs.	46"	1⅝" Adj.	2⅝" Adj.	14¾"	¼"	4,039.99
CYNERGY CLASSIC TRAP											
12	32"	013235426	F, F, IM	2¾"	8 lbs. 12 oz.	50¾"	1⅞"	2"	14⅝"	(¼" - ⅜")	\$3,869.99
12	30"	013235427	F, F, IM	2¾"	8 lbs. 10 oz.	48¾"	1⅞"	2"	14⅝"	(¼" - ⅜")	3,869.99
CYNERGY CLASSIC TRAP WITH ADJUSTABLE COMB											
12	32"	013254426	F, F, IM	2¾"	8 lbs. 15 oz.	50¾"	1⅞" Adj.	2" Adj.	14⅝"	(¼" - ⅜")	\$4,269.99
12	30"	013254427	F, F, IM	2¾"	8 lbs. 13 oz.	48¾"	1⅞" Adj.	2" Adj.	14⅝"	(¼" - ⅜")	4,269.99

*NOTE: Weights listed are approximate.

VECTORPRO



BACK-BORED TECHNOLOGY



CYNERGY CLASSIC TRAP UNSINGLE COMBO WITH ADJUSTABLE COMB GAUGE: 12 | GLOSS FINISH STOCK AND FOREARM

RECEIVER Steel • Silver nitride finish • Ultra-low profile • Jewelled monobloc • MonoLock Hinge

BARREL Double and single barrel sets included • Lightweight profile over and under barrel set

• Single barrel set features an adjustable Unsingle rib for fine-tuning of rib angle for sight picture and point of impact • Ported **ACTION** Reverse Striker ignition system • Impact Ejectors • Top-tang barrel selector/safety **STOCK** Gloss finish Monte Carlo Grade III/IV walnut stock with right-hand palm swell • Modified semi-beavertail forearm with finger grooves **FEATURES** Vector Pro™ lengthened forcing cones • Four Invector-Plus™ Midas™ Grade choke tubes • Triple Trigger™ System • HiViz® Pro-Comp fiber-optic sight • Green canvas fitted case with Cynergy logo



GA.	BARREL LENGTH	CODE NUMBER	CHOKES INCLUDED	CHAMBER	*AVG. WEIGHT	OVERALL LENGTHS	DROP AT COMB	DROP AT HEEL	LENGTH OF PULL	RIB WIDTH (TAPERED)	SUGG. RETAIL
12	32"/34"	013269479	F, F, F, IM	2 3/4"	8 lbs. 15 oz.	48 1/4" / 50 1/4"	1 1/16" Adj.	2" Adj.	14 3/8"	(1/4" - 3/8")	\$5,999.99
12	32"/32"	013269469	F, F, F, IM	2 3/4"	8 lbs. 15 oz.	48 1/4"	1 1/16" Adj.	2" Adj.	14 3/8"	(1/4" - 3/8")	5,999.99
12	30"/34"	013269468	F, F, F, IM	2 3/4"	8 lbs. 13 oz.	46 1/4" / 50 1/4"	1 1/16" Adj.	2" Adj.	14 3/8"	(1/4" - 3/8")	5,999.99
12	30"/32"	013269467	F, F, F, IM	2 3/4"	8 lbs. 13 oz.	46 1/4" / 48 1/4"	1 1/16" Adj.	2" Adj.	14 3/8"	(1/4" - 3/8")	5,999.99

*NOTE: Weights listed are approximate.

VECTORPRO™



BACK-BORED TECHNOLOGY



Recoil Pads for Composite Models*



Recoil Pads for Wood Models*



Composite Model Adjustable Comb



Spacers

CYNERGY ACCESSORIES RECOIL PADS | SPACERS | COMBS

DESCRIPTION	CODE NUMBER	SUGG. RETAIL
Short Composite Recoil Pad	11400	\$34.99
Medium Composite Recoil Pad	11401	34.99
Long Composite Recoil Pad	11402	34.99
Short Wood Recoil Pad	11410	34.99
Medium Wood Recoil Pad	11411	34.99
Long Wood Recoil Pad	11412	34.99
1/4" Composite Stock Spacer	11430	7.99
1/4" Wood Stock Spacer	11431	7.99
Cast-on Adj. Comb, Composite	11420	24.99
Cast-off Adj. Comb, Composite	11421	24.99

*NOTE: All new guns are shipped with medium pads.

Length of pull is adjustable from 13 3/4"-15" with the purchase of the recoil pads and stock spacers above. See page 22 for details on Inflex pads.



INVECTOR -PLUS™ CHOKE TUBE SYSTEM

The Invector-Plus interchangeable choke tube system provides consistent, dense shot patterns in the constriction needed for your shooting situation. The longer choke taper inside an Invector-Plus choke tube works with Back-Bored Technology to produce patterns with more uniform densities and fewer flyers. The superior design eliminates gases slipping between the choke tube and barrel that could damage the choke tube and the barrel. See pages 152 to 155 for a complete listing of choke tubes.

CHROME CHAMBERS

The BT-99 features a chrome-plated chamber to resist the toll thousands of shells can take on lesser quality guns. Corrosion resistance is also greatly improved.

VECTOR PRO™ LENGTHENED FORCING CONE

Longer, tapered Vector Pro dimensions minimize shot deformation and maximize pattern uniformity, consistency and density. Back-boring increases bore diameter specifications and decreases friction between the shot cup and the bore to maximize shot pellet velocity and reduce felt recoil. Reducing constriction from the forcing cone on the shot column results in fewer deformed pellets for more uniform patterns, and keeps more pellets in the central part of the pattern where they're needed to smoke clays.



BROWNING QUALITY AT EVERY LEVEL.

From the Micro to the top-end Golden Clays model, a BT-99 will deliver all day long. There is not a better single-barrel trap gun, at any price, than the rugged BT-99. These tough, reliable guns are built to elevate your trap game.



FOREARM

A beavertail forearm helps control recoil and assists hand-eye coordination.



RIB

High-post, 1/2" rib.



EXTRACTOR

The BT-99 features an extractor to lift hulls.



BT-99 GRADE III GAUGE: 12 | GLOSS FINISH STOCK AND FOREARM

RECEIVER Steel • Silver nitride finish • Gold accented, high-relief engraving **BARREL** High-post ventilated rib • Ported **ACTION** Extractor only **STOCK** Gloss finish Monte Carlo Grade III/IV walnut stock • Beavertail forearm **FEATURES** Vector-Pro™ lengthened forcing cone • Three Invector-Plus™ choke tubes • Adjustable comb optional • Ivory front and mid-bead sights

Grade III, Left

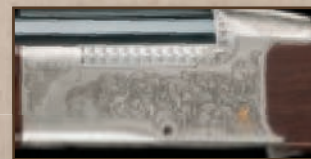

Grade III, Right

GA.	BARREL LENGTH	CODE NUMBER	CHOKES INCLUDED	CHAMBER	*AVG. WEIGHT	OVERALL LENGTH	DROP AT COMB	DROP AT HEEL	LENGTH OF PULL	RIB WIDTH	SUGG. RETAIL
BT-99 GRADE III											
12	34"	017070425	F, IM, M	2 3/4"	8 lbs. 6 oz.	51"	1 3/8"	2"	14 3/8"	1 1/2"	\$2,539.99
12	32"	017070426	F, IM, M	2 3/4"	8 lbs. 5 oz.	49"	1 3/8"	2"	14 3/8"	1 1/2"	2,539.99
BT-99 GRADE III WITH ADJUSTABLE COMB											
12	34"	017071425	F, IM, M	2 3/4"	8 lbs. 6 oz.	51"	1 1/4" Adj.	2" Adj.	14 3/8"	1 1/2"	\$2,829.99
12	32"	017071426	F, IM, M	2 3/4"	8 lbs. 5 oz.	49"	1 1/4" Adj.	2" Adj.	14 3/8"	1 1/2"	2,829.99

*NOTE: Weights listed are approximate.





BT-99 GOLDEN CLAYS WITH ADJUSTABLE COMB

GAUGE: 12 | GLOSS FINISH STOCK AND FOREARM

RECEIVER Steel • Silver nitride finish • Gold accented, high-relief engraving **BARREL** High-post ventilated rib • Ported **ACTION** Extractor only **STOCK** Gloss finish Grade V/VI walnut • Beavertail forearm **FEATURES** Vector-Pro™ lengthened forcing cone • Three Invector-Plus™ choke tubes • Adjustable straight comb • Adjustable GraCoil® recoil reduction system • Ivory front and mid-bead sights

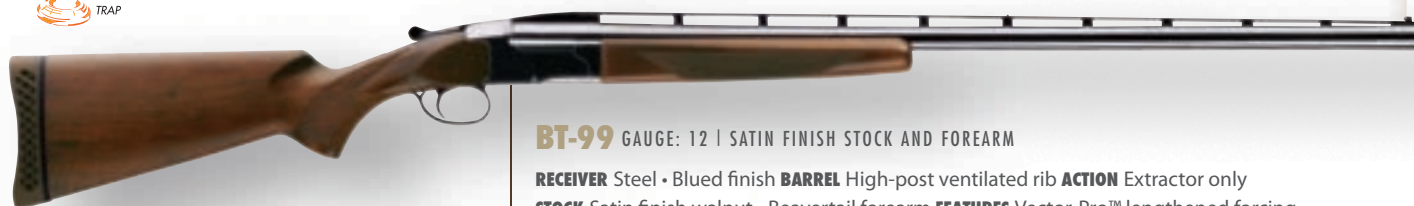

BT-99 GAUGE: 12 | SATIN FINISH STOCK AND FOREARM

RECEIVER Steel • Blued finish **BARREL** High-post ventilated rib **ACTION** Extractor only **STOCK** Satin finish walnut • Beavertail forearm **FEATURES** Vector-Pro™ lengthened forcing cone • Adjustable straight comb optional • Recoil pad • Ivory front and mid-bead sights • One Invector-Plus™ choke tube



Eligible for the Growth Insurance Program. See below for details.

BT-99 MICRO GAUGE: 12 | SATIN FINISH STOCK AND FOREARM

RECEIVER Steel • Blued finish **BARREL** High-post ventilated rib **ACTION** Extractor only **STOCK** Satin finish walnut • Beavertail forearm • Scaled down to comfortably fit smaller shooters **FEATURES** Vector-Pro™ lengthened forcing cone • Recoil pad • Ivory front and mid-bead sights • One Invector-Plus™ choke tube

GA.	BARREL LENGTH	CODE NUMBER	CHOKES INCLUDED	CHAMBER	*AVG. WEIGHT	OVERALL LENGTH	DROP AT COMB	DROP AT HEEL	LENGTH OF PULL	RIB WIDTH	SUGG. RETAIL
BT-99 GOLDEN CLAYS WITH ADJUSTABLE COMB											
12	34"	017057401	F, IM, M	2¾"	9 lbs.	51"	1½" Adj.	1¼" Adj.	13¾" - 14¾"	1½"	\$4,339.99
12	32"	017057402	F, IM, M	2¾"	8 lbs. 15 oz.	49"	1½" Adj.	1¼" Adj.	13¾" - 14¾"	1½"	4,339.99
BT-99 (SHOWN)											
12	34"	017054401	Full	2¾"	8 lbs. 5 oz.	51"	1½"	1½"	14¾"	1½"	\$1,429.99
12	32"	017054402	Full	2¾"	8 lbs. 4 oz.	49"	1½"	1½"	14¾"	1½"	1,429.99
BT-99 WITH ADJUSTABLE COMB											
12	34"	017055401	Full	2¾"	8 lbs. 5 oz.	51"	1½" Adj.	1¼" Adj.	14¾"	1½"	\$1,679.99
12	32"	017055402	Full	2¾"	8 lbs. 4 oz.	49"	1½" Adj.	1¼" Adj.	14¾"	1½"	1,679.99
BT-99 MICRO											
12	32"	017061402	Full	2¾"	7 lbs. 13 oz.	48½"	1½"	1½"	13¾"	1½"	\$1,429.99
12	30"	017061403	Full	2¾"	7 lbs. 12 oz.	46½"	1½"	1½"	13¾"	1½"	1,429.99

*NOTE: Weights listed are approximate.

BROWNING GROWTH INSURANCE PROGRAM

Purchasing a firearm for a growing shooter is a tough decision to make. You can choose an inexpensive "youth" model with questionable quality that will soon be outgrown. Or you can buy a quality adult-size firearm they can "grow into" but may prevent them from reaching their shooting potential because of poor fit. We offer the perfect solution with the Growth Insurance Program. Purchase a new Browning Micro Midas or Micro firearm and you are eligible to purchase a full-size stock at 50% off the retail price down the road. That's a big savings for you, and it allows the shooter to enjoy a firearm of the highest quality that is sure to fit and maximize their shooting performance and enjoyment, both now and for years to come. Visit browning.com for complete details.



All Browning firearms are shipped with a free locking device to assist in the safe storage of firearms.

MAXIMUM RELIABILITY. MAXIMUM PERFORMANCE.

Real-world reliability is the most important feature any manufacturer can build into a firearm. That's why it was the first priority when we set about developing the Browning Maxus. The Power Drive Gas System is designed to perform under harsh hunting and shooting conditions with a wide array of loads. But reliability isn't the whole story. The Maxus delivers 18% less felt recoil for greater comfort, 44% less muzzle jump for more accurate follow-up shots, 19% faster bolt speed and 24% faster locktime than the nearest competitor. Unequaled reliability and features, all found in the finest, most reliable gas-operated autoloader ever to swing on a bird.

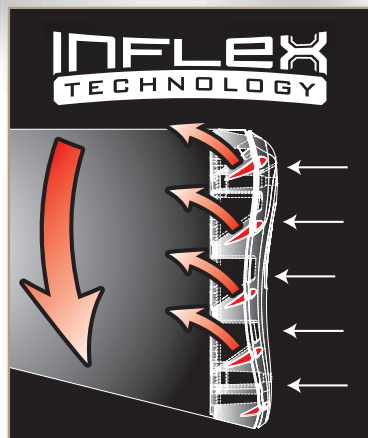

INFLEX TECHNOLOGY RECOIL PAD

The Inflex Technology recoil pad is the softest pad on any autoloader. More than a mass of recoil absorbing material, it has been engineered with directional deflection to pull the comb down and away from your face with every shot for even greater comfort and faster follow-up shooting.



SPEED LOCK FOREARM

The traditional screw-on magazine cap has been replaced with the patented Speed Lock Forearm. This secure forearm attachment system makes taking down the Maxus for cleaning or storage fast and makes attaching or removing the sling a snap.

THE SOFTEST SHOOTING AUTOLOADER EVER

Felt recoil is more than just an instantaneous peak force; it is the total energy absorbing experience when you fire a shell. While no recoil reduction system can escape the laws of physics, the Maxus will change your mind about recoil control. The Power Drive Gas System, Inflex Technology recoil pad, back-boring and natural Browning balance combine to transfer up to 18% less total felt recoil force to your shoulder than other autoloaders on the market.

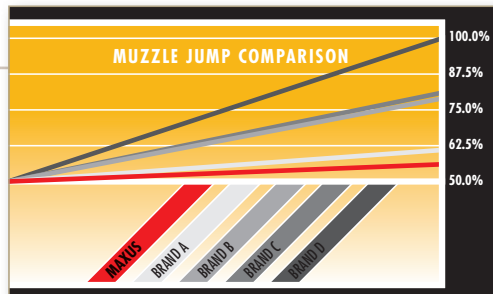

LESS MUZZLE JUMP

Less felt recoil means less muzzle jump and that instantly translates into more birds in your bag. The Power Drive Gas System works perfectly with the Inflex Technology recoil pad to reduce muzzle jump as much as 44% compared to the competition.

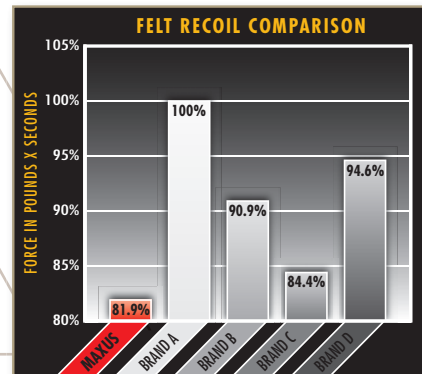

STEEL SHOT PERFORMANCE

The strength of Browning barrels is legendary, and built to handle the punishment of steel shot. Unlike some manufacturers' barrels that show pitting after shooting steel, we have pioneered construction that maximizes steel shot performance and barrel durability. Our barrels meet the strictest material and construction quality standards. The barrel blanks are made from rolled and tempered steel bars and are stress relieved to offer exceptional mechanical properties. The barrel blanks are then precision drilled, reamed and honed to exacting specifications. With proper care, a Browning Maxus barrel will last a lifetime.



The forcing cone of the competition is pitted and damaged beyond repair after 500 rounds of steel shot.

After 500 rounds of steel shot, the higher-quality Browning barrel shows no wear.



VECTOR PRO™ LENGTHENED FORCING CONE

We were the first manufacturer to recognize the performance advantages of a back-bored barrel and to make it a standard feature on our shotguns. Now we have gone a step further with our Vector Pro lengthened forcing cone. Longer, tapered Vector Pro dimensions minimize shot deformation and maximize pattern uniformity, consistency and density. Back-boring increases bore diameter specifications and decreases friction between the shot cup and the bore to maximize shot pellet velocity and to reduce felt recoil. Reducing constriction from the forcing cone on the shot column results in fewer deformed pellets for more uniform patterns, and keeps more pellets in the central part of the pattern where they're needed to bag more upland birds, waterfowl and clay targets. A larger bore diameter can let gases slip by the shot cup, resulting in both reduced pellet velocity and blown patterns. A smaller bore diameter means the forcing cone can deform pellets, leading to flyers and poor ballistic performance.

Our back-bore specifications represent the ideal bore dimensions.

VECTORPRO

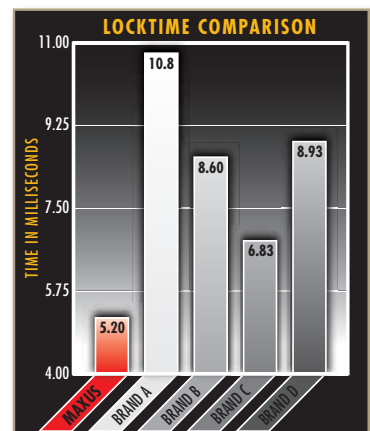

TOTAL BARREL DYNAMICS

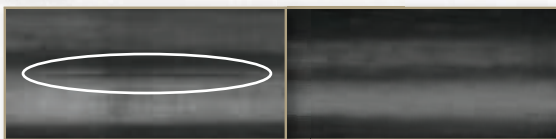

The competitors' choke tube is grooved and pitted after shooting 500 rounds of steel shot.

Browning's Invector-Plus choke tube is still flawless after 500 rounds of steel.

INVECTOR-PLUS™ CHOKE SYSTEM

The proven Invector-Plus interchangeable choke tube system works with Vector Pro™ and back-boring to offer consistent, dense shot patterns with just the constriction needed for the shooting situation. The longer choke taper inside an Invector-Plus choke tube produces consistent patterns with more uniform densities and fewer flyers. The superior design of the Invector-Plus system is far more durable than the choke systems found in our competitors' guns, especially when shooting steel shot. Invector-Plus eliminates gases slipping between the choke tube and barrel that could damage the choke tube and the barrel. See page 152 through 155 for a complete listing of choke tubes.

BACK-BORED TECHNOLOGY

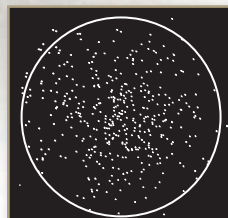

Browning pattern with Back-Bored Technology

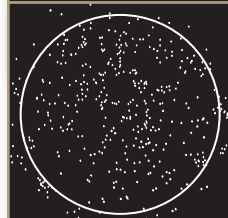

The competitors' pattern without Back-Bored Technology

LIGHTNING TRIGGER

A great feeling trigger isn't just for the rifle crowd. The Lightning Trigger is the finest fire control system ever offered in an autoloading shotgun. It is designed to offer a smooth, crisp feel with minimal travel. With locktimes averaging .0052 seconds, the Lightning Trigger is 24% faster than the nearest competing autoloader, making every pull perfect. It's also easy to remove for cleaning.

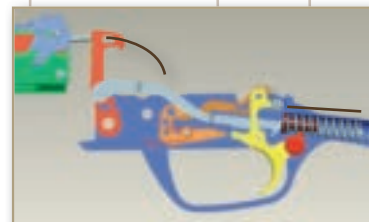

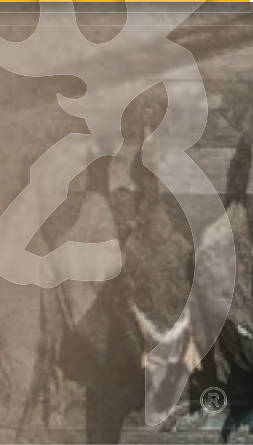

BAR N' GRILL



MAGAZINE CUT-OFF

The Maxus is equipped with a magazine cut-off that allows you to easily unload the chamber to change loads for different birds without cycling a shell from the magazine.



MAXIMUM GRIP

Composite models combine in-molded textured gripping surfaces and our proven Dura-Touch® Armor Coating for a sure hold and a sleek feel in all climate conditions.

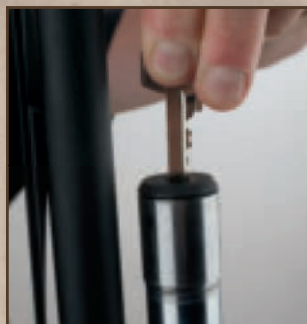

TURNKEY
MAGAZINE PLUG

The patented TurnKey Magazine Plug is easily removed using a vehicle key. Combined with the Speed Lock System, the magazine plug can be removed from the Maxus in mere seconds.



POWERDRIVE
GAS SYSTEM

The Power Drive Gas System is the finest gas system on any autoloading shotgun ever. Extensive research and testing have produced a piston design that is extremely reliable in all conditions, regardless of the heavy or light loads being used. The gas piston features larger exhaust ports that dump gases faster with heavy loads to control recoil and 20% longer stroke travel to increase reliability with light loads. A patented, enclosed seal design keeps residue out of the action for cleaner operation. Maxus with Power Drive equals outstanding performance.

SPEED LOAD
PLUS

Speed Loading has been popular on our autoloaders for decades. Our patented feeding system sends the first shell loaded into the magazine directly into the chamber. Unloading is just as easy with the Speed Unload feature that makes emptying the magazine fast and easy, without having to cycle and chamber every shell with the bolt handle.

MAXUS EXTRA BARRELS

MODEL	GA.	BARREL LENGTH	CODE NUMBER	CHOKES INCLUDED	CHAMBER	RATE OF TWIST	SUGG. RETAIL
Hunter	12	30"	111608303	F, M, IC	3"	—	\$339.99
Hunter	12	28"	111608304	F, M, IC	3"	—	339.99
Hunter	12	26"	111608305	F, M, IC	3"	—	339.99
Hunter	12	30"	111608203	F, M, IC	3½"	—	419.99
Hunter	12	28"	111608204	F, M, IC	3½"	—	419.99
Hunter	12	26"	111608205	F, M, IC	3½"	—	419.99
Stalker	12	28"	111600304	F, M, IC	3"	—	339.99
Stalker	12	26"	111600305	F, M, IC	3"	—	339.99
Stalker	12	28"	111600204	F, M, IC	3½"	—	419.99
Stalker	12	26"	111600205	F, M, IC	3½"	—	419.99
MODB	12	28"	111601304	F, M, IC	3"	—	379.99
MODB	12	26"	111601305	F, M, IC	3"	—	379.99
MODB	12	28"	111601204	F, M, IC	3½"	—	439.99
MODB	12	26"	111601205	F, M, IC	3½"	—	439.99
Rifled Deer Stalker**	12	22"	111620321	Rif. Bbl./Cant.	3"	1 in 28"	459.99

** To prevent damage to forearms, all Maxus rifled cantilever barrels are delivered with a new forearm specifically designed to fit over the thicker rifled barrel walls.



Hunter, Left



Hunter, Right

MAXUS HUNTER GAUGE: 12 | GLOSS FINISH STOCK AND FOREARM

RECEIVER Strong, lightweight aluminum alloy • Durable satin nickel finish • Laser engraving (pheasant on the right, mallard on the left) **BARREL** Lightweight profile • Flat, ventilated rib **ACTION** Gas-operated autoloader • 3" and 3½" chamber models • Power Drive Gas System reduces recoil and cycles a wide range of loads **STOCK** Gloss finish walnut with close radius pistol grip • Sharp 22 lines-per-inch checkering • Speed Lock Forearm • Shim adjustable for length of pull, cast and drop **FEATURES** Vector Pro™ lengthened forcing cone • Three Invector-Plus™ choke tubes • Inflex Technology recoil pad • Ivory front bead sight • One ¼" stock spacer



Hi-Viz Sight Set



MAXUS ALL-PURPOSE, MOSSY OAK® BREAK-UP INFINITY®

GAUGE: 12 | DURA-TOUCH® ARMOR COATING ON STOCK AND FOREARM

RECEIVER Strong, lightweight aluminum alloy • Drilled and tapped for scope mounts **BARREL** Lightweight profile • Flat, ventilated rib **ACTION** Gas-operated autoloader • 3½" chamber • Power Drive Gas System reduces recoil and cycles a wide range of loads **STOCK** Composite with close radius pistol grip • Speed Lock Forearm • Textured gripping surfaces • Shim adjustable for length of pull, cast and drop • Mossy Oak® Break-Up Infinity® camo finish • Dura-Touch® Armor Coating **FEATURES** Vector Pro™ lengthened forcing cone • Four Invector-Plus™ choke tubes (XF Turkey Tube included) • HiViz® magnetic combo sight set • Inflex Technology recoil pad • Ivory front bead sight • One ¼" stock spacer



MAXUS RIFLED DEER, MOSSY OAK® BREAK-UP INFINITY®

GAUGE: 12 | DURA-TOUCH® ARMOR COATING ON STOCK AND FOREARM

RECEIVER Strong, lightweight aluminum alloy **BARREL** Thick-walled, fully rifled for slug ammunition only **ACTION** Gas-operated autoloader • 3" chamber • Power Drive Gas System reduces recoil and cycles a wide range of loads **STOCK** Composite with close radius pistol grip • Speed Lock Forearm • Textured gripping surfaces • Shim adjustable for length of pull, cast and drop • Mossy Oak® Break-Up Infinity® camo finish • Dura-Touch® Armor Coating **FEATURES** Cantilever scope mount • Inflex Technology recoil pad • One ¼" stock spacer

GA.	BARREL LENGTH	CODE NUMBER	CHOKES INCLUDED	CHAMBER	*AVG. WEIGHT	OVERALL LENGTH	DROP AT COMB	DROP AT HEEL	LENGTH OF PULL	RATE OF TWIST	RIB WIDTH	SUGG. RETAIL
MAXUS HUNTER												
12	30"	011608303	F, M, IC	3"	7 lbs. 1 oz.	51"	1¾"	2"	14¼"	—	¼"	\$1,499.99
12	28"	011608304	F, M, IC	3"	7 lbs.	49"	1¾"	2"	14¼"	—	¼"	1,499.99
12	26"	011608305	F, M, IC	3"	6 lbs. 15 oz.	47"	1¾"	2"	14¼"	—	¼"	1,499.99
12	30"	011608203	F, M, IC	3½"	7 lbs. 1 oz.	51"	1¾"	2"	14¼"	—	¼"	1,639.99
12	28"	011608204	F, M, IC	3½"	7 lbs.	49"	1¾"	2"	14¼"	—	¼"	1,639.99
12	26"	011608205	F, M, IC	3½"	6 lbs. 15 oz.	47"	1¾"	2"	14¼"	—	¼"	1,639.99
MAXUS ALL-PURPOSE, MOSSY OAK BREAK-UP INFINITY												
12	26"	011619205	XF, F, M, IC	3½"	6 lbs. 15 oz.	47¼"	1¾"	2"	14¼"	—	¼"	\$1,679.99
MAXUS RIFLED DEER, MOSSY OAK BREAK-UP INFINITY												
12	22"	011617321	Rif. Bbl./Cant.	3"	7 lbs. 3 oz.	43¼"	1¾"	2"	14¼"	1 in 28"	—	\$1,589.99





DURA-TOUCH
Armor Coating

MAXUS RIFLED DEER STALKER

GAUGE: 12 | DURA-TOUCH® ARMOR COATING ON STOCK AND FOREARM

RECEIVER Strong, lightweight aluminum alloy **BARREL** Thick-walled, fully rifled for slug ammunition only **ACTION** Gas-operated autoloader • 3" chamber • Power Drive Gas System reduces recoil and cycles a wide range of loads **STOCK** Composite with close radius pistol grip • Speed Lock Forearm • Textured gripping surfaces • Shim adjustable for length of pull, cast and drop • Matte black finish • Dura-Touch® Armor Coating **FEATURES** Cantilever scope mount • Inflex Technology recoil pad • One ¼" stock spacer



DURA-TOUCH
Armor Coating

MAXUS SPORTING CARBON FIBER



GAUGE: 12 | DURA-TOUCH® ARMOR COATING ON STOCK AND FOREARM

RECEIVER Strong, lightweight aluminum alloy • Carbon fiber finish on top and bottom **BARREL** Lightweight profile • Flat, ventilated rib • Carbon fiber finish **ACTION** Gas-operated autoloader • 3" chamber • Power Drive Gas System reduces recoil and cycles a wide range of loads **STOCK** Composite with close radius pistol grip • Speed Lock Forearm • Textured gripping surfaces • Shim adjustable for length of pull, cast and drop • Carbon fiber finish • Dura-Touch® Armor Coating **FEATURES** Vector Pro™ lengthened forcing cone • Five Invector-Plus™ choke tubes • Inflex Technology recoil pad • HiViz® Pro-Comp fiber-optic front sight • Ivory mid-bead sight • Two ¼" stock spacers • Included ABS case



OPTIMAL DIMENSIONS

The Maxus features a trim forearm and close radius pistol grip to maximize control. An externally relieved steel magazine tube reduces weight for a faster swing while retaining durability. Drop and cast can be tuned using the included stock shim kit. A low rib is in line with the top of the receiver and translates into dead-flat point of impact.

GA.	BARREL LENGTH	CODE NUMBER	CHOKES INCLUDED	CHAMBER	*AVG. WEIGHT	OVERALL LENGTH	DROP AT COMB	DROP AT HEEL	LENGTH OF PULL	RATE OF TWIST	RIB WIDTH (TAPERED)	SUGG. RETAIL
MAXUS RIFLED DEER STALKER												
12	22"	011620321	Rif. Bbl./Cant.	3"	7 lbs. 3 oz.	43¼"	1¾"	2"	14¼"	1 in 28"	—	\$1,469.99
MAXUS SPORTING CARBON FIBER												
12	30"	011609303	F, IM, M, IC, SK	3"	7 lbs.	51"	1¾"	2"	14¼"	—	8-6 mm	\$1,499.99
12	28"	011609304	F, IM, M, IC, SK	3"	6 lbs. 15 oz.	49"	1¾"	2"	14¼"	—	8-6 mm	1,499.99

*NOTE: Weights listed are approximate.





DURA-TOUCH
Armor Coating

MAXUS STALKER GAUGE: 12 | DURA-TOUCH® ARMOR COATING ON STOCK AND FOREARM

RECEIVER Strong, lightweight aluminum alloy **BARREL** Lightweight profile • Flat, ventilated rib **ACTION** Gas-operated autoloader • 3" and 3½" chamber models • Power Drive Gas System reduces recoil and cycles a wide range of loads **STOCK** Composite with close radius pistol grip • Speed Lock Forearm • Textured gripping surfaces • Shim adjustable for length of pull, cast and drop • Matte black finish • Dura-Touch® Armor Coating **FEATURES** Vector Pro™ lengthened forcing cone • Three Invector-Plus™ choke tubes • Inflex Technology recoil pad • Ivory front bead sight • One ¼" stock spacer



MOSSY OAK
DUCK BLIND
DURA-TOUCH
Armor Coating

MAXUS, MOSSY OAK® DUCK BLIND®

GAUGE: 12 | DURA-TOUCH® ARMOR COATING ON STOCK AND FOREARM

RECEIVER Strong, lightweight aluminum alloy **BARREL** Lightweight profile • Flat, ventilated rib **ACTION** Gas-operated autoloader • 3" and 3½" chamber models • Power Drive Gas System reduces recoil and cycles a wide range of loads **STOCK** Composite with close radius pistol grip • Speed Lock Forearm • Textured gripping surfaces • Shim adjustable for length of pull, cast and drop • Mossy Oak® Duck Blind® camo finish • Dura-Touch® Armor Coating **FEATURES** Vector Pro™ lengthened forcing cone • Three Invector-Plus™ choke tubes • Inflex Technology recoil pad • Ivory front bead sight • One ¼" stock spacer



MAXUS SPORTING

GAUGE: 12 | GLOSS FINISH STOCK AND FOREARM



RECEIVER Strong, lightweight aluminum alloy • Durable satin nickel finish • Laser engraving of game birds transforming into clay birds (quail on the right, mallard on the left) **BARREL** Lightweight profile • Flat, ventilated rib **ACTION** Gas-operated autoloader • 3" chamber • Power Drive Gas System reduces recoil and cycles a wide range of loads **STOCK** Gloss finish high grade walnut with close radius pistol grip • Speed Lock Forearm • Shim adjustable for length of pull, cast and drop **FEATURES** Vector Pro™ lengthened forcing cone • Five Invector-Plus™ choke tubes • Inflex Technology recoil pad • HiViz® Pro-Comp fiber-optic front sight • Ivory mid-bead sight • Two ¼" stock spacers • Included ABS case

GA.	BARREL LENGTH	CODE NUMBER	CHOKES INCLUDED	CHAMBER	*AVG. WEIGHT	OVERALL LENGTH	DROP AT COMB	DROP AT HEEL	LENGTH OF PULL	RIB WIDTH	SUGG. RETAIL
MAXUS STALKER											
12	28"	011600304	F, M, IC	3"	6 lbs. 15 oz.	49¼"	1¼"	2"	14¼"	¼"	\$1,339.99
12	26"	011600305	F, M, IC	3"	6 lbs. 14 oz.	47¼"	1¼"	2"	14¼"	¼"	1,339.99
12	28"	011600204	F, M, IC	3½"	6 lbs. 15 oz.	49¼"	1¼"	2"	14¼"	¼"	1,499.99
12	26"	011600205	F, M, IC	3½"	6 lbs. 14 oz.	47¼"	1¼"	2"	14¼"	¼"	1,499.99
MAXUS, MOSSY OAK DUCK BLIND											
12	28"	011601304	F, M, IC	3"	6 lbs. 15 oz.	49¼"	1¼"	2"	14¼"	¼"	\$1,469.99
12	26"	011601305	F, M, IC	3"	6 lbs. 14 oz.	47¼"	1¼"	2"	14¼"	¼"	1,469.99
12	28"	011601204	F, M, IC	3½"	6 lbs. 15 oz.	49¼"	1¼"	2"	14¼"	¼"	1,599.99
12	26"	011601205	F, M, IC	3½"	6 lbs. 14 oz.	47¼"	1¼"	2"	14¼"	¼"	1,599.99
MAXUS SPORTING											
12	30"	011616303	F, IM, M, IC, SK	3"	7 lbs. 1 oz.	51"	1¼"	2"	14¼"	8-6 mm	\$1,699.99
12	28"	011616304	F, IM, M, IC, SK	3"	7 lbs.	49"	1¼"	2"	14¼"	8-6 mm	1,699.99

*NOTE: Weights listed are approximate.



BROWNING QUALITY AND LASTING VALUE.

If you put value right next to performance when selecting an autoloading shotgun, pick up a reliable, no-nonsense Browning Silver. These value-added guns offer features like Browning fit and finish, predictable handling and reliable versatility — the things that matter most to hunters — when hunting pheasant, duck, deer or turkey. With a Silver, affordability doesn't require compromise.



LOAD VERSATILITY

The Active Valve-equipped gas piston efficiently adjusts to reliably fire a wide range of loads. 12 gauge 3" models fire everything from light, 1 oz., 2¾" target loads to the heaviest 3" magnums. The larger 3½" version is built to handle a similar range, from 1½ oz., 2¾" field loads up to hard-hitting 3½" magnums. Competitors' guns can't match this versatility.



TRIGGER

The trigger guard is large and has carefully rounded edges to accommodate gloved fingers. Additionally, the Silver's entire trigger assembly can be removed in just seconds for a thorough cleaning.



LESS RECOIL WITH THE ACTIVE VALVE

The self-adjusting Active Valve gas system in Silver autoloaders diverts gases from fired shells to operate the action instead of adding to recoil. When shooting light loads, most of the gases operate the action. With magnum loads, only a small amount of gas is necessary to operate the action, while the remaining gases are vented through the Active Valve and out the top of the forearm and away from the receiver for clean, reliable operation. The gas piston and Active Valve operate independently, putting less pressure on the gas piston for greater longevity and more efficient operation than the competitors' gas-operated autoloaders. Because the Active Valve expels unnecessary gases, it reduces recoil before it ever strikes your shoulder — without the need for heavy hydraulic recoil dampers, sticky gel pads and gimmicky gel stock inserts. Superior recoil reduction from the Active Valve also equals faster, more accurate follow-up shots and all-day shooting comfort regardless of the loads you shoot.



Light Load (1 oz.)



Heavy Load (2 oz.)



BACK-BORED BARREL TECHNOLOGY

Back-boring reduces friction between the shot cup and the bore for increased shot pellet velocity, minimized pellet deformation for more uniform patterns and reduced felt recoil. We were the first manufacturer to put back-boring and its advantages into production shotguns. Through intense research, our back-bore specifications have been perfected and represent the ideal bore diameter needed to minimize shot deformation and maximize pattern uniformity, consistency and density. Any larger and gases slip by the shot cup, resulting in reduced pellet velocity and blown patterns. Any smaller, and the forcing cone will deform pellets and result in poor ballistic performance, flyers and uneven, spotty pellet coverage on the target.

INVECTOR-PLUS™ CHOKE TUBE SYSTEM

The proven Invector-Plus interchangeable choke tube system comes on every Silver shotgun to provide consistent, dense shot patterns in just the constriction needed for your shooting situation. The longer choke taper inside an Invector-Plus choke tube works hand-in-hand with Back-Bored Technology to produce consistent patterns with more uniform densities and fewer flyers. The superior design of the Invector-Plus system is far more durable than the choke systems found in competitors' guns, especially when shooting steel shot loads. Invector-Plus eliminates gases slipping between the choke tube and barrel that could damage both the choke tube and the barrel. See pages 152 to 155 for a complete listing of choke tubes.

STEEL SHOT PERFORMANCE

The strength of Browning barrels is legendary, and built to handle the punishment of steel shot. Unlike some manufacturers' barrels that show pitting after shooting steel, we have pioneered construction that maximizes steel shot performance and barrel durability. Our barrels meet the strictest material and construction quality standards. The barrel blanks are made from rolled and tempered steel bars and are stress relieved to offer exceptional mechanical properties. The barrel blanks are then precision drilled, reamed and honed to exacting specifications. With proper care, a Browning Silver barrel will last a lifetime.

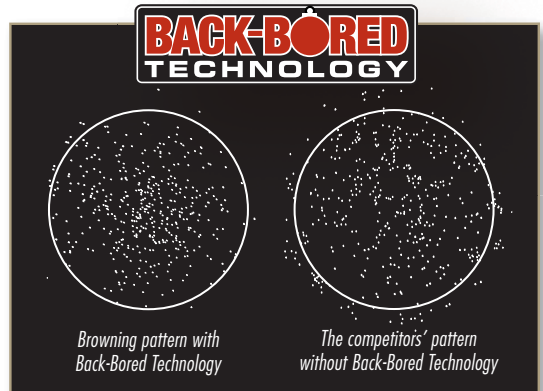

Browning pattern with Back-Bored Technology

The competitor's pattern without Back-Bored Technology



Eligible for the Growth Insurance Program. See page 31 for details.

SILVER HUNTER MICRO MIDAS

GAUGE: 12 (SHOWN), 20 | SATIN FINISH STOCK AND FOREARM

- RECEIVER** Strong, lightweight aluminum alloy • Semi-humpback design • Silver finish
- BARREL** Lightweight profile • Ventilated rib **ACTION** Gas-operated autoloader • 3" chamber
- Active Valve System reliably cycles a wide range of loads **STOCK** Satin finish • Compact 13" length of pull for smaller shooters **FEATURES** Three Invector-Plus™ choke tubes
- Ivory front bead sight • One ¼" stock spacer

MAGAZINE CAPACITY

- 2¾": Four in magazine, one in chamber.
 - 3": Three in magazine, one in chamber.
 - 3½": Three in magazine, one in chamber.
- (A three-shot magazine adapter plug is included.)

GA.	BARREL LENGTH	CODE NUMBER	CHOKES INCLUDED	CHAMBER	*AVG. WEIGHT	OVERALL LENGTH	DROP AT COMB	DROP AT HEEL	LENGTH OF PULL	RIB WIDTH	SUGG. RETAIL
12	26"	011389305	F, M, IC	3"	7 lbs. 5 oz.	45¾"	1½"	1¾"	13"	¼"	\$1,179.99
12	24"	011389306	F, M, IC	3"	7 lbs. 3 oz.	43¾"	1½"	1¾"	13"	¼"	1,179.99
20	26"	011389605	F, M, IC	3"	6 lbs. 2 oz.	45¾"	1½"	1¾"	13"	¼"	1,179.99
20	24"	011389606	F, M, IC	3"	6 lbs.	43¾"	1½"	1¾"	13"	¼"	1,179.99

*NOTE: Weights listed are approximate.



SILVER HUNTER GAUGE: 12 (SHOWN), 20 | SATIN FINISH STOCK AND FOREARM

RECEIVER Strong, lightweight aluminum alloy • Semi-humpback design • Silver finish
BARREL Lightweight profile • Ventilated rib **ACTION** Gas-operated autoloader • 3" and 3½"
 chamber models • Active Valve System reliably cycles a wide range of loads **STOCK** Satin
 finish walnut **FEATURES** Three Invector-Plus™ choke tubes • Ivory front bead sight

Eligible for the Growth Insurance Program. See page 31 for details.



SILVER MICRO GAUGE: 20 | SATIN FINISH STOCK AND FOREARM

RECEIVER Strong, lightweight aluminum alloy • Semi-humpback design • Silver finish **BARREL**
 Lightweight profile • Ventilated rib **ACTION** Gas-operated autoloader • 3" chamber • Active Valve
 System reliably cycles a wide range of loads **STOCK** Satin finish walnut • Compact stock dimensions
 fit smaller shooters **FEATURES** Three Invector-Plus™ choke tubes • Ivory front bead sight

Eligible for the Growth Insurance Program. See page 31 for details.



SILVER SPORTING MICRO GAUGE: 12 | GLOSS FINISH STOCK AND FOREARM

RECEIVER Strong, lightweight aluminum alloy • Semi-humpback design • Silver finish
BARREL Lightweight profile • Ventilated rib • Ported **ACTION** Gas-operated autoloader
 • 2¾" chamber • Active Valve System reliably cycles a wide range of loads **STOCK** Gloss finish
 walnut • Stock features ¾" length of pull adjustment in ¼" increments using the three included
 adjustment spacers • Premium Pachmayr® Decelerator® recoil pad **FEATURES** Three Invector-Plus™
 choke tubes • Ivory front bead sight

GA.	BARREL LENGTH	CODE NUMBER	CHOKES INCLUDED	CHAMBER	*AVG. WEIGHT	OVERALL LENGTH	DROP AT COMB	DROP AT HEEL	LENGTH OF PULL	RIB WIDTH	SUGG. RETAIL
SILVER HUNTER											
12	28"	011350204	F, M, IC	3½"	7 lbs. 9 oz.	49"	1½"	2"	14¼"	¼"	\$1,339.99
12	26"	011350205	F, M, IC	3½"	7 lbs. 8 oz.	47"	1½"	2"	14¼"	¼"	1,339.99
12	30"	011350303	F, M, IC	3"	7 lbs. 6 oz.	51"	1½"	2"	14¼"	¼"	1,179.99
12	28"	011350304	F, M, IC	3"	7 lbs. 5 oz.	49"	1½"	2"	14¼"	¼"	1,179.99
12	26"	011350305	F, M, IC	3"	7 lbs. 4 oz.	47"	1½"	2"	14¼"	¼"	1,179.99
20	28"	011350604	F, M, IC	3"	6 lbs. 7 oz.	48¾"	1½"	2¼"	14¼"	¼"	1,179.99
20	26"	011350605	F, M, IC	3"	6 lbs. 5 oz.	46¾"	1½"	2¼"	14¼"	¼"	1,179.99
SILVER MICRO											
20	26"	011375605	F, M, IC	3"	6 lbs. 3 oz.	46"	1½"	1¾"	13¾"	¼"	\$1,179.99
SILVER SPORTING MICRO											
12	28"	011373428	F, M, IC	2¾"	7 lbs. 5 oz.	48"	1½"	1¾"	13¾" Adj.	¼"	\$1,299.99

*NOTE: Weights listed are approximate.



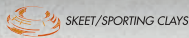
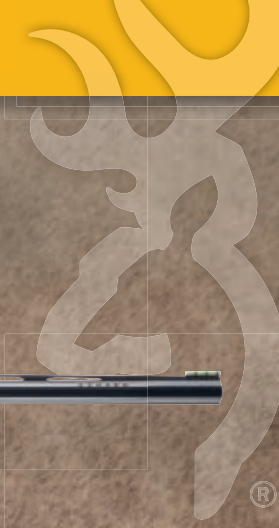

SILVER SPORTING GAUGE: 12 | GLOSS FINISH STOCK AND FOREARM

RECEIVER Strong, lightweight aluminum alloy • Semi-humpback design • Silver finish **BARREL** Lightweight profile • Ventilated rib • Ported **ACTION** Gas-operated autoloader • 2¾" chamber • Active Valve System reliably cycles a wide range of loads **STOCK** Gloss finish walnut stock and forearm • Stock features ¾" length of pull adjustment in ¼" increments using the three included adjustment spacers • Premium Pachmayr® Decelerator® recoil pad **FEATURES** Three Invector-Plus™ choke tubes • HiViz® TriComp fiber-optic sight • Ivory mid-bead sight • Two Active Valve pistons included to optimize performance with light or heavy loads



SILVER LIGHTNING FULL LINE DEALER

GAUGE: 12 | GLOSS FINISH STOCK AND FOREARM

RECEIVER Strong, lightweight aluminum alloy • Semi-humpback design • Silver finish **BARREL** Lightweight profile • Ventilated rib **ACTION** Gas-operated autoloader • 3" and 3½" chamber models • Active Valve System reliably cycles a wide range of loads **STOCK** Lightning-style, gloss finish walnut stock **FEATURES** Three Invector-Plus™ choke tubes • Ivory front bead sight • Available only from Browning Full Line and Medallion Dealers



SILVER STALKER

GAUGE: 12 | DURA-TOUCH® ARMOR COATING ON STOCK AND FOREARM

RECEIVER Strong, lightweight aluminum alloy • Semi-humpback design **BARREL** Lightweight profile • Ventilated rib **ACTION** Gas-operated autoloader • 3½" chamber • Active Valve System reliably cycles a wide range of loads **STOCK** Composite • Matte black finish • Dura-Touch® Armor Coating **FEATURES** Three Invector-Plus™ choke tubes • Ivory front bead sight



GA.	BARREL LENGTH	CODE NUMBER	CHOKES INCLUDED	CHAMBER	*AVG. WEIGHT	OVERALL LENGTH	DROP AT COMB	DROP AT HEEL	LENGTH OF PULL	RIB WIDTH	SUGG. RETAIL
SILVER SPORTING											
12	30"	011377427	F, M, IC	2¾"	7 lbs. 9 oz.	50¾"	1½"	1¼"	14¼" Adj.	¼"	\$1,299.99
12	28"	011377428	F, M, IC	2¾"	7 lbs. 8 oz.	48¾"	1½"	1¼"	14¼" Adj.	¼"	1,299.99
SILVER LIGHTNING FULL LINE DEALER											
12	28"	011368204	F, M, IC	3½"	7 lbs. 9 oz.	49"	1¾"	2"	14¼"	¼"	\$1,359.99
12	26"	011368205	F, M, IC	3½"	7 lbs. 8 oz.	47"	1¾"	2"	14¼"	¼"	1,359.99
12	28"	011368304	F, M, IC	3"	7 lbs. 6 oz.	49"	1¾"	2"	14¼"	¼"	1,179.99
12	26"	011368305	F, M, IC	3"	7 lbs. 4 oz.	47"	1¾"	2"	14¼"	¼"	1,179.99
SILVER STALKER											
12	28"	011351204	F, M, IC	3½"	7 lbs. 9 oz.	49"	1¾"	2"	14¼"	¼"	\$1,199.99
12	26"	011351205	F, M, IC	3½"	7 lbs. 8 oz.	47"	1¾"	2"	14¼"	¼"	1,199.99

*NOTE: Weights listed are approximate.





SILVER, MOSSY OAK® BREAK-UP INFINITY®

GAUGE: 12 | DURA-TOUCH® ARMOR COATING ON STOCK AND FOREARM

RECEIVER Strong, lightweight aluminum alloy • Semi-humpback design **BARREL** Lightweight profile • Ventilated rib **ACTION** Gas-operated autoloader • 3½" chamber • Active Valve System reliably cycles a wide range of loads **STOCK** Composite • Dura-Touch® Armor Coating • Mossy Oak® Break-Up Infinity® camo finish **FEATURES** Three Invector-Plus™ choke tubes • Ivory front bead sight



SILVER, MOSSY OAK® DUCK BLIND®

GAUGE: 12 | DURA-TOUCH® ARMOR COATING ON STOCK AND FOREARM

RECEIVER Strong, lightweight aluminum alloy • Semi-humpback design **BARREL** Lightweight profile • Ventilated rib **ACTION** Gas-operated autoloader • 3½" chamber • Active Valve System reliably cycles a wide range of loads **STOCK** Composite • Dura-Touch® Armor Coating • Mossy Oak® Duck Blind® camo finish **FEATURES** Three Invector-Plus™ choke tubes • Ivory front bead sight



SILVER NWTF, MOSSY OAK® BREAK-UP INFINITY®

GAUGE: 12 | DURA-TOUCH® ARMOR COATING ON STOCK AND FOREARM

RECEIVER Strong, lightweight aluminum alloy • Semi-humpback design • Drilled and tapped for scope mounts **BARREL** Lightweight profile • Ventilated rib **ACTION** Gas-operated autoloader • 3" and 3½" chamber models • Active Valve System reliably cycles a wide range of loads **STOCK** Composite • Dura-Touch® Armor Coating • Mossy Oak® Break-Up Infinity® camo finish **FEATURES** HiViz® 4-in-1 fiber-optic sight • Three Invector-Plus™ choke tubes



ULTIMATE CONCEALMENT

We offer our guns in the most cutting edge, three-dimensional camo patterns available. Realistic 3D camouflage patterns blend into nature to keep you hidden from cautious, wary eyes.



MAXIMUM GRIP

Composite Silver models combine checkered gripping surfaces and proven Dura-Touch® Armor Coating for a sure hold and a sleek feel in all climate conditions.

GA.	BARREL LENGTH	CODE NUMBER	CHOKES INCLUDED	CHAMBER	*AVG. WEIGHT	OVERALL LENGTH	DROP AT COMB	DROP AT HEEL	LENGTH OF PULL	RIB WIDTH	SUGG. RETAIL
SILVER MOSSY OAK BREAK-UP INFINITY											
12	26"	011384205	F, M, IC	3½"	7 lbs. 8 oz.	47"	1¼"	2"	14¼"	¼"	\$1,339.99
SILVER MOSSY OAK DUCK BLIND											
12	28"	011366204	F, M, IC	3½"	7 lbs. 9 oz.	49"	1¼"	2"	14¼"	¼"	\$1,339.99
12	26"	011366205	F, M, IC	3½"	7 lbs. 8 oz.	47"	1¼"	2"	14¼"	¼"	1,339.99
SILVER NWTF, MOSSY OAK BREAK-UP INFINITY											
12	24"	011385206	Full Str Trky, M, IC	3½"	7 lbs. 4 oz.	45"	1¼"	2"	14¼"	¼"	\$1,539.99
12	24"	011385306	XF, M, IC	3"	7 lbs.	45"	1¼"	2"	14¼"	¼"	1,359.99

*NOTE: Weights listed are approximate.





DURA-TOUCH®
Armor Coating



SILVER RIFLED DEER, MOSSY OAK® BREAK-UP INFINITY®

GAUGE: 12 (SHOWN), 20 | DURA-TOUCH® ARMOR COATING ON STOCK AND FOREARM

RECEIVER Strong, lightweight aluminum alloy • Semi-humpback design

BARREL Thick-walled for slug ammunition only **ACTION** Gas-operated autoloader • 3" chamber • Active Valve System reliably cycles a wide range of loads

STOCK Composite • Dura-Touch® Armor Coating • Mossy Oak® Break-Up Infinity® camo finish **FEATURES** Cantilever scope mount



DURA-TOUCH®
Armor Coating

SILVER RIFLED DEER STALKER

GAUGE: 12 | DURA-TOUCH® ARMOR COATING ON STOCK AND FOREARM

RECEIVER Strong, lightweight aluminum alloy • Semi-humpback design

BARREL Thick-walled for slug ammunition only **ACTION** Gas-operated autoloader • 3" chamber • Active Valve System reliably cycles a wide range of loads

STOCK Composite • Dura-Touch® Armor Coating • Matte black finish **FEATURES** Cantilever scope mount



SILVER RIFLED DEER SATIN GAUGE: 20 | SATIN FINISH STOCK AND FOREARM

RECEIVER Strong, lightweight aluminum alloy • Semi-humpback design **BARREL** Thick-walled for slug ammunition only **ACTION** Gas-operated autoloader • 3" chamber • Active Valve System reliably cycles a wide range of loads **STOCK** Satin finish walnut **FEATURES** Cantilever scope mount (Scope and rings not included)

GA.	BARREL LENGTH	CODE NUMBER	CHOKES INCLUDED	CHAMBER	*AVG. WEIGHT	OVERALL LENGTH	DROP AT COMB	DROP AT HEEL	LENGTH OF PULL	RATE OF TWIST	SUGG. RETAIL
SILVER RIFLED DEER, MOSSY OAK BREAK-UP INFINITY											
12	22"	011386321	Rif. Bbl./Cant.	3"	7 lbs. 12 oz.	43"	1¼"	2"	14¼"	1 in 28"	\$1,419.99
20	22"	011386621	Rif. Bbl./Cant.	3"	6 lbs. 12 oz.	42¾"	1¼"	2¼"	14¼"	1 in 24"	1,419.99
SILVER RIFLED DEER STALKER											
12	22"	011351321	Rif. Bbl./Cant.	3"	7 lbs. 12 oz.	43"	1¼"	2"	14¼"	1 in 28"	\$1,279.99
SILVER RIFLED DEER SATIN											
20	22"	011371621	Rif. Bbl./Cant.	3"	6 lbs. 12 oz.	42¾"	1¼"	2¼"	14¼"	1 in 24"	\$1,339.99

*NOTE: Weights listed are approximate.





A5™ EXTRA BARRELS

MODEL	GA.	BARREL LENGTH	CODE NUMBER	CHOKES INCLUDED	CHAMBER	RATE OF TWIST	SUGG. RETAIL
NEW Hunter	12	30"	1118003003	F, M, IC	3"	—	\$399.99
NEW Hunter	12	28"	1118003004	F, M, IC	3"	—	399.99
NEW Hunter	12	26"	1118003005	F, M, IC	3"	—	399.99
NEW Stalker	12	30"	1118013003	F, M, IC	3"	—	399.99
NEW Stalker	12	28"	1118013004	F, M, IC	3"	—	399.99
NEW Stalker	12	26"	1118013005	F, M, IC	3"	—	399.99
NEW MOINF	12	30"	1118023003	F, M, IC	3"	—	439.99
NEW MOINF	12	28"	1118023004	F, M, IC	3"	—	439.99
NEW MOINF	12	26"	1118023005	F, M, IC	3"	—	439.99
NEW MODB	12	30"	1118033003	F, M, IC	3"	—	439.99
NEW MODB	12	28"	1118033004	F, M, IC	3"	—	439.99
NEW MODB	12	26"	1118033005	F, M, IC	3"	—	439.99

A5 shotgun barrels listed in this chart are designed to fit A5 shotguns built in 2012 and later. They are not compatible with any other Browning autoloading shotgun.

SILVER® EXTRA BARRELS

MODEL	GA.	BARREL LENGTH	CODE NUMBER	CHOKES INCLUDED	CHAMBER	RATE OF TWIST	SUGG. RETAIL
Hunter	12	28"	111350204	F, M, IC	3½"	—	\$419.99
Hunter	12	26"	111350205	F, M, IC	3½"	—	419.99
Hunter	12	30"	111350303	F, M, IC	3"	—	339.99
Hunter	12	28"	111350304	F, M, IC	3"	—	339.99
Hunter	12	26"	111350305	F, M, IC	3"	—	339.99
Hunter/Micro*	20	28"	111350604	F, M, IC	3"	—	339.99
Hunter/Micro*	20	26"	111350605	F, M, IC	3"	—	339.99
Deer Satin	20	22"	111371621	Rif. Bbl./Cant.	3"	1 in 24"	419.99
Stalker	12	28"	111351204	F, M, IC	3½"	—	419.99
Stalker	12	26"	111351205	F, M, IC	3½"	—	419.99
Deer MONBU**	12	22"	111379321	Rif. Bbl./Cant.	3"	1 in 28"	539.99
Deer MOINF**	12	22"	111387321	Rif. Bbl./Cant.	3"	1 in 28"	539.99
Deer Stalker**	12	22"	111380321	Rif. Bbl./Cant.	3"	1 in 28"	459.99
MONBU	12	24"	111352206	F, M, IC	3½"	—	439.99
MOINF	12	24"	111384206	F, M, IC	3½"	—	439.99
MOINF	12	26"	111384205	F, M, IC	3½"	—	439.99
MODB	12	28"	111366204	F, M, IC	3½"	—	439.99
MODB	12	26"	111366205	F, M, IC	3½"	—	439.99

*20 gauge Silver shotgun barrels fit on Silver Hunter and Silver Micro 20 gauge models.

**To prevent damage to forearms, all Silver rifled cantilever barrels are delivered with a new forearm specifically designed to fit over the thicker, rifled barrel walls.

GOLD® EXTRA BARRELS

MODEL	GA.	BARREL LENGTH	CODE NUMBER	CHOKES INCLUDED	CHAMBER	RATE OF TWIST	SUGG. RETAIL
GOLD 12 GAUGE CAMOUFLAGE							
MONBU	12	22"	111116221	Rif. Bbl./Cant.	3½"	1 in 28"	\$620.99
MONSG	12	26"	111117305	F, M, IC	3"	—	432.99
GOLD 12 & 20 GAUGE							
Deer Hunter	12	22"	111106220	Rif. Bbl./Cant.	3½"	1 in 28"	\$503.99
Deer Hunter	12	22"	111106319	Rif. Tube/Cant.	3"	1 in 28"	435.99
Fusion	20	28"	111141604	F, M, IC	3"	—	480.99
Fusion	20	26"	111141605	F, M, IC	3"	—	480.99
GOLD 12 & 20 GAUGE SUPERLITE HUNTER							
SL Hunter	12	28"	111259304	F, M, IC	3"	—	\$402.99
SL Hunter	12	26"	111259305	F, M, IC	3"	—	402.99
SL Hunter	20	28"	111259604	F, M, IC	3"	—	402.99
GOLD EVOLVE 12 GAUGE							
Evolve Sporting	12	30"	111262427	F, M, IC	2¾"	—	\$552.99
Evolve Sporting	12	28"	111262428	F, M, IC	2¾"	—	552.99
Evolve	12	30"	111149303	F, M, IC	3"	—	514.99
Evolve	12	28"	111149304	F, M, IC	3"	—	514.99
Evolve	12	26"	111149305	F, M, IC	3"	—	514.99
GOLD 10 GAUGE CAMOUFLAGE							
MOINF	10	28"	111280113	F, M, IC	3½"	—	\$354.99
MOINF	10	26"	111280114	F, M, IC	3½"	—	354.99
MOINF	10	24"	111280115	XF Turkey	3½"	—	354.99
MODB	10	28"	111270113	F, M, IC	3½"	—	354.99
MODB	10	26"	111270114	F, M, IC	3½"	—	354.99



Mossy Oak® Break-Up Infinity® camo will be offered in conjunction with New Break-Up® camo on select Browning extra barrels.

IMPORTANT: DO NOT ATTEMPT THE USE OF 3½" CHAMBERED BARRELS WITH 3" RECEIVERS NOR 3" CHAMBERED BARRELS WITH 3½" RECEIVERS.

WHACK 'EM AND STACK 'EM.

When heavy birds like Canada and snow geese are diving on your blind, or big toms are strutting out yonder, nothing beats the pure power and reliable performance of a burly Browning 10 gauge shotgun.

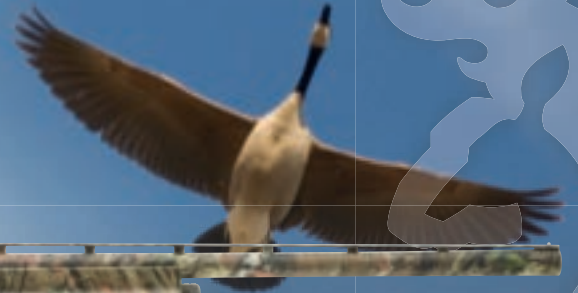

GOLD® LIGHT 10 GAUGE

GAUGE: 10 | DURA-TOUCH® ARMOR COATING ON STOCK AND FOREARM

RECEIVER Aluminum alloy **BARREL** Ventilated rib **ACTION** Gas-operated autoloader • 3½" chamber • Magazine capacity - Four in the magazine plus one in the chamber **STOCK** Composite • Dura-Touch® Armor Coating • Mossy Oak® camo finishes **FEATURES** Three Standard Invector™ choke tubes • NWT model includes HiViz® 4-in-1 fiber-optic sight



BPS® 10 GAUGE

GAUGE: 10 | NON-GLARE COMPOSITE FINISH ON STOCK AND FOREARM

RECEIVER Forged and machined steel **BARREL** Ventilated rib **ACTION** Bottom ejection • Dual steel action bars • 3½" chamber • Top-tang safety • Magazine capacity - Four in the magazine plus one in the chamber **STOCK** Composite • Dura-Touch® Armor Coating • Mossy Oak® camo finishes • Matte black on Stalker **FEATURES** Three Standard Invector™ choke tubes • Brass front bead sight



NWT BPS® 10 GAUGE, MOSSY OAK® BREAK-UP INFINITY®

GAUGE: 10 | DURA-TOUCH® ARMOR COATING ON STOCK AND FOREARM

RECEIVER Forged and machined steel • Drilled and tapped for scope mounts **BARREL** Ventilated rib • 24" length **ACTION** Bottom ejection • Dual steel action bars • 3½" chamber • Top-tang safety • Magazine capacity - Four in the magazine plus one in the chamber **STOCK** Composite • Dura-Touch® Armor Coating • Mossy Oak® Break-Up Infinity® camo finish • NWT logo **FEATURES** Standard Invector™ X-Full Turkey choke tube • HiViz® 4-in-1 fiber-optic sight • Endorsed by the National Wild Turkey Federation

GA.	BARREL LENGTH	CODE NUMBER	CHOKES INCLUDED	CHAMBER	*AVG. WEIGHT	OVERALL LENGTH	DROP AT COMB	DROP AT HEEL	LENGTH OF PULL	RIB WIDTH	SUGG. RETAIL	
GOLD LIGHT 10 GAUGE, MOSSY OAK BREAK-UP INFINITY (SHOWN) AND MOSSY OAK DUCK BLIND												
MOINF	10	28"	011280113	F, M, IC	3½"	9 lbs. 10 oz.	50"	1½"	2½"	14½"	⅝"	\$1,739.99
MOINF	10	26"	011280114	F, M, IC	3½"	9 lbs. 9 oz.	48"	1½"	2½"	14½"	⅝"	1,739.99
NWTF/MOINF	10	24"	011281115	XF Turkey	3½"	9 lbs. 4 oz.	46"	1½"	2½"	14½"	⅝"	1,869.99
MODB	10	28"	011270113	F, M, IC	3½"	9 lbs. 10 oz.	50"	1½"	2½"	14½"	⅝"	1,739.99
MODB	10	26"	011270114	F, M, IC	3½"	9 lbs. 9 oz.	48"	1½"	2½"	14½"	⅝"	1,739.99
BPS 10 GAUGE STALKER												
Stalker	10	28"	012212113	F, M, IC	3½"	10 lbs. 9 oz.	50"	1½"	2½"	14¼"	⅝"	\$759.99
Stalker	10	26"	012212114	F, M, IC	3½"	10 lbs. 8 oz.	48"	1½"	2½"	14¼"	⅝"	759.99
BPS 10 GAUGE, MOSSY OAK BREAK-UP INFINITY AND MOSSY OAK DUCK BLIND (SHOWN)												
MOINF	10	28"	012257113	F, M, IC	3½"	10 lbs. 9 oz.	50"	1½"	2½"	14¼"	⅝"	\$899.99
MOINF	10	26"	012257114	F, M, IC	3½"	10 lbs. 8 oz.	48"	1½"	2½"	14¼"	⅝"	899.99
MODB	10	28"	012243113	F, M, IC	3½"	10 lbs. 9 oz.	50"	1½"	2½"	14¼"	⅝"	899.99
MODB	10	26"	012243114	F, M, IC	3½"	10 lbs. 8 oz.	48"	1½"	2½"	14¼"	⅝"	899.99
NWTF BPS 10 GAUGE, MOSSY OAK BREAK-UP INFINITY												
MOINF	10	24"	012258115	XF Turkey	3½"	10 lbs. 3 oz.	46"	1½"	2½"	14¼"	⅝"	\$979.99

*NOTE: Weights listed are approximate.



**THE BROWNING BPS.
THE BEST PUMP SHOTGUN AVAILABLE.**

In an industry cluttered with budget-priced, lesser quality pump shotguns, the BPS remains a steadfast alternative with rugged steel construction and legendary Browning precision. There is a BPS shotgun ready to chase nearly every game, from slug models for deer, to small gauge guns for doves, to competition-worthy trap models. The BPS has proven itself reliable and has seen tough duty in marshes, cornfields and on shooting ranges. Rely on a BPS to come through, regardless of the conditions.

TANG SAFETY

The thumb-operated, top-tang safety on the BPS can easily be operated with the right or left hand, even with gloved fingers.



BACK-BORED BARREL TECHNOLOGY

We were the first manufacturer to recognize the advantages of a back-bored barrel. Back-boring increases the bore diameter to reduce friction between the shot cup and the bore to maximize shot velocity and reduce felt recoil. Our back-bore specifications have been researched, perfected and represent the ideal bore diameter needed to minimize shot deformation and maximize pattern uniformity, consistency and density. Any larger and gases slip by the shot cup, resulting in reduced pellet velocity and blown patterns. Any smaller, and the forcing cone will deform pellets and result in poor ballistic performance, flyers and uneven, spotty pellet coverage on the target.

INVECTOR™ CHOKE TUBE SYSTEMS

The proven Standard Invector (28 gauge, .410 bore) or Invector-Plus™ (12, 20 gauge) interchangeable choke tube systems are featured on every BPS shotgun and provide consistent, dense shot patterns in the constriction needed for the specific shooting situation. The longer choke taper inside an Invector-Plus choke tube works with back-boring to produce dense patterns with uniform densities and fewer flyers. The superior designs of the Invector systems are far more durable than the choke systems found in competitors' guns, especially when shooting steel shot loads. The Invector systems eliminate gases slipping between the choke tube and barrel that could damage both the choke tube and the barrel. See pages 152 to 155 for a complete listing of choke tubes.



STEEL SHOT PERFORMANCE

The strength of Browning barrels is legendary, and built to handle the punishment of steel shot. Unlike some manufacturers' barrels that show pitting after shooting steel, we have pioneered construction that maximizes steel shot performance and barrel durability. Our barrels meet the strictest material and construction quality standards. The barrel blanks are made from rolled and tempered steel bars and are stress relieved to offer exceptional mechanical properties. The barrel blanks are then precision drilled, reamed and honed to exacting specifications. With proper care, a Browning BPS barrel will last a lifetime.



BACK-BORED TECHNOLOGY

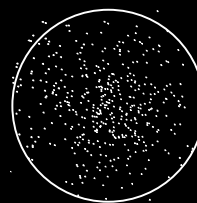

Browning pattern with Back-Bored Technology

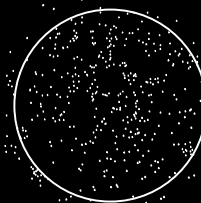

The competitors' pattern without Back-Bored Technology



BPS HUNTER GAUGE: 12 (SHOWN), 16, 20, 28, .410 | SATIN FINISH STOCK AND FOREARM

RECEIVER Forged and machined steel **BARREL** Ventilated rib **ACTION** Bottom ejection • Dual steel action bars • Top-tang safety **STOCK** Satin finish walnut **FEATURES** Three Invector-Plus™ choke tubes with 12 and 20 • Three Standard Invector™ with 16, 28 and .410 • Recoil pad on 12 gauge model • Brass front bead sight

MAGAZINE CAPACITY

2¾": Four in magazine, one in chamber.
 3": Three in magazine, one in chamber.
 3½": Three in magazine, one in chamber.
 (A three-shot magazine adapter plug is included.)

BPS UPLAND SPECIAL GAUGE: 12, 16, 20 (SHOWN) | SATIN FINISH STOCK AND FOREARM

RECEIVER Forged and machined steel **BARREL** Ventilated rib **ACTION** Bottom ejection • Dual steel action bars • Top-tang safety **STOCK** Satin finish walnut • English-style straight grip **FEATURES** Three Invector-Plus™ choke tubes with 12 and 20 • Three Standard Invector™ with 16 • Brass front bead sight

Eligible for the Growth Insurance Program. See page 31 for details.



BPS MICRO

GAUGE: 20 | SATIN FINISH STOCK AND FOREARM

RECEIVER Forged and machined steel
BARREL Compact 22" length • Ventilated rib
ACTION Bottom ejection • Dual steel action bars • Top-tang safety **STOCK** Satin finish walnut • Compact dimensions to suit smaller shooters **FEATURES** Three Invector-Plus™ choke tubes • Brass front bead sight

BOTTOM EJECTION AND LOADING

Unique bottom ejection provides operating convenience by throwing empty shells straight down, out of your line of sight, making the BPS the best pump shotgun choice for both right- and left-handed shooters.



RELIABLE PUMP-ACTION

The proven pump-action design of the BPS is sound and reliable. All components are durably constructed of solid steel and housed inside a receiver machined from a solid block of forged steel. Rigid double slide bars are made from heat-treated steel to eliminate twisting and binding for faster, more efficient operation. The BPS offers smooth operation in all conditions and gives you the ability to stay on target while delivering rapid follow-up shots. A convenient serrated slide release is located at the rear of the trigger guard.

GA.	BARREL LENGTH	CODE NUMBER	CHOKES INCLUDED	CHAMBER	*AVG. WEIGHT	OVERALL LENGTH	DROP AT COMB	DROP AT HEEL	LENGTH OF PULL	RIB WIDTH	SUGG. RETAIL
BPS HUNTER											
12	28"	012211304	F, M, IC	3"	7 lbs. 11 oz.	48¾"	1⅝"	1⅞"	14¼"	⅝"	\$659.99
12	26"	012211305	F, M, IC	3"	7 lbs. 10 oz.	46¾"	1⅝"	1⅞"	14¼"	⅝"	659.99
16	28"	012211513	F, M, IC	2¾"	7 lbs. 2 oz.	48¾"	1⅝"	1⅞"	14¼"	⅝"	699.99
16	26"	012211514	F, M, IC	2¾"	7 lbs. 1 oz.	46¾"	1⅝"	1⅞"	14¼"	⅝"	699.99
20	28"	012211604	F, M, IC	3"	7 lbs. 1 oz.	48¾"	1⅝"	1⅞"	14¼"	⅝"	659.99
20	26"	012211605	F, M, IC	3"	7 lbs.	46¾"	1⅝"	1⅞"	14¼"	⅝"	659.99
28	28"	012211813	F, M, IC	2¾"	7 lbs.	48¾"	1⅝"	1⅞"	14¼"	⅝"	699.99
28	26"	012211814	F, M, IC	2¾"	6 lbs. 15 oz.	46¾"	1⅝"	1⅞"	14¼"	⅝"	699.99
.410	26"	012211914	F, M, IC	3"	7 lbs.	46¾"	1⅝"	1⅞"	14¼"	⅝"	699.99
BPS UPLAND SPECIAL											
12	22"	012216307	F, M, IC	3"	7 lbs. 8 oz.	42½"	1⅝"	1⅞"	14"	⅝"	\$659.99
16	26"	012216514	F, M, IC	2¾"	6 lbs. 13 oz.	46½"	1⅝"	1⅞"	14"	⅝"	699.99
16	24"	012216515	F, M, IC	2¾"	6 lbs. 12 oz.	44½"	1⅝"	1⅞"	14"	⅝"	699.99
20	22"	012216607	F, M, IC	3"	6 lbs. 11 oz.	42½"	1⅝"	1⅞"	14"	⅝"	659.99
BPS MICRO											
20	22"	012225607	F, M, IC	3"	6 lbs. 14 oz.	41¾"	1⅝"	1⅞"	13¼"	⅝"	\$659.99

*NOTE: Weights listed are approximate.





BPS Rifled Deer, 12 gauge

BPS Rifled Deer, 20 gauge

DURA-TOUCH®
Armor Coating

BPS RIFLED DEER, MOSSY OAK® BREAK-UP INFINITY®

GAUGE: 12, 20 | DURA-TOUCH® ARMOR COATING ON STOCK AND FOREARM

- RECEIVER** Forged and machined steel **BARREL** Thick-walled for slug ammunition only
- Rifled, 12 gauge: 1 in 28" twist, 20 gauge: 1 in 24" twist **ACTION** Bottom ejection
 - Dual steel action bars • Top-tang safety **STOCK** 12 gauge: composite, 20 gauge: wood
 - Dura-Touch® Armor Coating • Mossy Oak® Break-Up Infinity® camo finish

FEATURES Cantilever scope mount

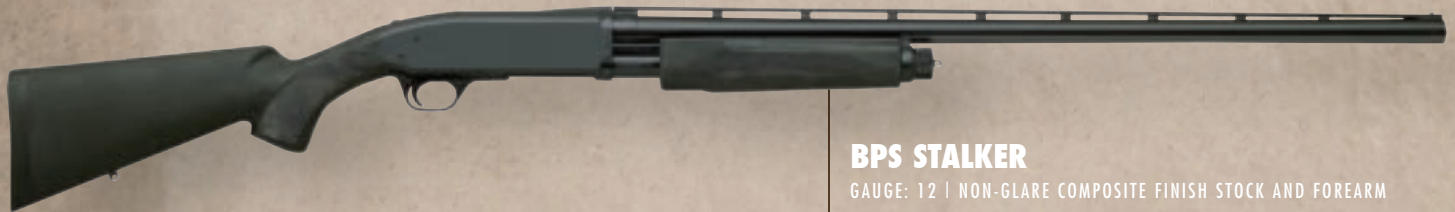

BPS STALKER

GAUGE: 12 | NON-GLARE COMPOSITE FINISH STOCK AND FOREARM

- RECEIVER** Forged and machined steel **BARREL** Ventilated rib
- ACTION** Bottom ejection • Dual steel action bars • Top-tang safety
- STOCK** Composite • Matte black finish **FEATURES** Three Invector-Plus™ choke tubes • Brass front bead sight



MAXIMUM GRIP

Camo composite BPS models combine in-molded checkered gripping surfaces and our proven Dura-Touch® Armor Coating for a sure hold and a sleek feel in all climate conditions.



BPS Mossy Oak® Duck Blind®

GA.	BARREL LENGTH	CODE NUMBER	CHOKES INCLUDED	CHAMBER	*AVG. WEIGHT	OVERALL LENGTH	DROP AT COMB	DROP AT HEEL	LENGTH OF PULL	RIB WIDTH	SUGG. RETAIL
BPS RIFLED DEER, MOSSY OAK BREAK-UP INFINITY											
12	22"	012259324	Rif. Bbl./Cant.	3"	7 lbs. 10 oz.	42½"	1½"	2½"	14¼"	—	\$829.99
20	22"	012259624	Rif. Bbl./Cant.	3"	7 lbs. 5 oz.	42¼"	1½"	1½"	14¼"	—	939.99
BPS STALKER											
12	30"	012212303	F, M, IC	3"	8 lbs. 2 oz.	50¾"	1½"	2½"	14¼"	⅜"	\$659.99
12	28"	012212304	F, M, IC	3"	8 lbs. 1 oz.	48¾"	1½"	2½"	14¼"	⅜"	659.99
12	26"	012212305	F, M, IC	3"	8 lbs.	46¾"	1½"	2½"	14¼"	⅜"	659.99
12	28"	012212204	F, M, IC	3½"	8 lbs. 5 oz.	49¼"	1½"	2½"	14¼"	⅜"	759.99
12	26"	012212205	F, M, IC	3½"	8 lbs. 4 oz.	47¼"	1½"	2½"	14¼"	⅜"	759.99

*NOTE: Weights listed are approximate.





BPS RIFLED DEER HUNTER

GAUGE: 12 (SHOWN), 20 | SATIN FINISH STOCK AND FOREARM

RECEIVER Forged and machined steel **BARREL** Thick-walled for slug ammunition only
 • Rifled, 12 gauge: 1 in 28" twist, 20 gauge: 1 in 24" twist **ACTION** Bottom ejection • Dual steel action bars • Top-tang safety **STOCK** Satin finish walnut **FEATURES** Cantilever scope mount



BPS, MOSSY OAK® BREAK-UP INFINITY®

GAUGE: 12 | DURA-TOUCH® ARMOR COATING ON STOCK AND FOREARM

RECEIVER Forged and machined steel • NWTF® model is drilled and tapped for scope mounts **BARREL** Ventilated rib **ACTION** Bottom ejection • Dual steel action bars • Top-tang safety **STOCK** Composite • Dura-Touch® Armor Coating • Mossy Oak® Break-Up Infinity® camo finish **FEATURES** Three Invector-Plus™ choke tubes • NWTF® models include the HiViz® 4-in-1 fiber-optic sight and buttstock decal



BPS, MOSSY OAK® DUCK BLIND®

GAUGE: 12 | DURA-TOUCH® ARMOR COATING ON STOCK AND FOREARM

RECEIVER Forged and machined steel **BARREL** Ventilated rib **ACTION** Bottom ejection • Dual steel action bars • Top-tang safety **STOCK** Composite • Dura-Touch® Armor Coating • Mossy Oak® Duck Blind® camo finish **FEATURES** Three Invector-Plus™ choke tubes • Brass front bead sight



GA.	BARREL LENGTH	CODE NUMBER	CHOKES INCLUDED	CHAMBER	*AVG. WEIGHT	OVERALL LENGTH	DROP AT COMB	DROP AT HEEL	LENGTH OF PULL	RIB WIDTH	RATE OF TWIST	SUGG. RETAIL
BPS RIFLED DEER HUNTER												
12	22"	012214324	Rif. Bbl./Cant.	3"	7 lbs. 10 oz.	42½"	1½"	2½"	13¾"	—	1 in 28"	\$789.99
20	22"	012214624	Rif. Bbl./Cant.	3"	7 lbs. 4 oz.	42¼"	1¾"	1¾"	13¾"	—	1 in 24"	799.99
BPS, MOSSY OAK BREAK-UP INFINITY												
12	28"	012257204	F, M, IC	3½"	8 lbs. 5 oz.	49¼"	1½"	2½"	14¼"	⅝"	—	\$899.99
12	26"	012257205	F, M, IC	3½"	8 lbs. 4 oz.	47¼"	1½"	2½"	14¼"	⅝"	—	899.99
NWTF	12	24"	012258206	XF Trky, M, IC	3½"	8 lbs. 3 oz.	45¼"	1½"	2½"	14¼"	⅝"	979.99
12	28"	012257304	F, M, IC	3"	8 lbs. 1 oz.	48¾"	1½"	2½"	14¼"	⅝"	—	779.99
12	26"	012257305	F, M, IC	3"	8 lbs.	46¾"	1½"	2½"	14¼"	⅝"	—	779.99
NWTF	12	24"	012258306	XF Trky, M, IC	3"	7 lbs. 15 oz.	44¾"	1½"	2½"	14¼"	⅝"	909.99
BPS, MOSSY OAK DUCK BLIND												
12	28"	012243204	F, M, IC	3½"	8 lbs. 5 oz.	49¼"	1½"	2½"	14¼"	⅝"	—	\$899.99
12	26"	012243205	F, M, IC	3½"	8 lbs. 4 oz.	47¼"	1½"	2½"	14¼"	⅝"	—	899.99
12	28"	012243304	F, M, IC	3"	8 lbs. 1 oz.	48¾"	1½"	2½"	14¼"	⅝"	—	779.99
12	26"	012243305	F, M, IC	3"	8 lbs.	46¾"	1½"	2½"	14¼"	⅝"	—	779.99

*NOTE: Weights listed are approximate.



BPS TRAP GAUGE: 12 | SATIN FINISH STOCK AND FOREARM

RECEIVER Engraved • Forged and machined steel • Highly polished blue finish
BARREL Ventilated rib **ACTION** Bottom ejection • Dual steel action bars • Top-tang safety
STOCK Satin finish walnut • Raised comb **FEATURES** Magazine cut-off • Three
 Investor-Plus™ choke tubes • HiViz® ProComp fiber-optic sight with mid-bead

Magazine Cut-off

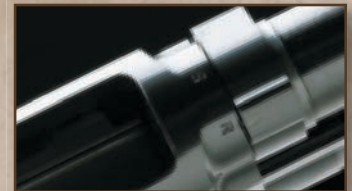

Eligible for the Growth Insurance Program. See below for details.



BPS MICRO TRAP GAUGE: 12 | SATIN FINISH STOCK AND FOREARM

RECEIVER Engraved • Forged and machined steel • Highly polished blue
 finish **BARREL** Ventilated rib **ACTION** Bottom ejection • Dual steel action
 bars • Top-tang safety **STOCK** Satin finish walnut • Raised comb • Compact
 stock dimensions to fit smaller shooters **FEATURES** Magazine cut-off • Three
 Investor-Plus™ choke tubes • HiViz® ProComp fiber-optic sight with mid-bead

Magazine Cut-off

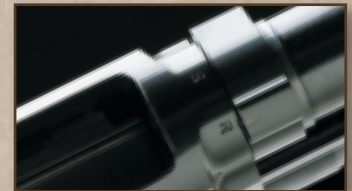

GA.	BARREL LENGTH	CODE NUMBER	CHOKES INCLUDED	CHAMBER	*AVG. WEIGHT	OVERALL LENGTH	DROP AT COMB	DROP AT HEEL	LENGTH OF PULL	RIB WIDTH	SUGG. RETAIL
BPS TRAP											
12	30"	012242403	F, IM, M	2 ³ / ₄ "	8 lbs. 6 oz.	51"	1 ³ / ₈ "	2"	14 ³ / ₈ "	5 ¹ / ₁₆ "	\$799.99
BPS MICRO TRAP											
12	28"	012241404	F, IM, M	2 ³ / ₄ "	8 lbs. 1 oz.	48 ¹ / ₄ "	1 ³ / ₈ "	2"	13 ³ / ₄ "	5 ¹ / ₁₆ "	\$799.99

*NOTE: Weights listed are approximate.

BROWNING GROWTH INSURANCE PROGRAM

Purchasing a firearm for a growing shooter is a tough decision to make. You can choose an inexpensive "youth" model with questionable quality that will soon be outgrown. Or you can buy a quality adult-size firearm they can "grow into" but may prevent them from reaching their shooting potential because of poor fit. We offer the perfect solution with the Growth Insurance Program. Purchase a new Browning Micro Midas or Micro firearm and you are eligible to purchase a full-size stock at 50% off the retail price down the road. That's a big savings for you, and it allows the shooter to enjoy a firearm of the highest quality that is sure to fit and maximize their shooting performance and enjoyment, both now and for years to come. Visit browning.com for complete details.





Mossy Oak® Break-Up Infinity® camo will be offered in conjunction with New Break-Up camo on select Browning extra barrels.

BPS® EXTRA BARRELS

MODEL	GA.	BARREL LENGTH	CODE NUMBER	CHOKES INCLUDED	CHAMBER	FEATURES	RATE OF TWIST	SUGG. RETAIL
10 GAUGE								
Hunter	10	28"	111211113	F, M, IC	3½"	—	—	\$309.99
Hunter	10	26"	111211114	F, M, IC	3½"	—	—	309.99
Hunter	10	24"	111211115	F, M, IC	3½"	—	—	309.99
Stalker	10	28"	111212113	F, M, IC	3½"	—	—	309.99
Stalker	10	26"	111212114	F, M, IC	3½"	—	—	309.99
Stalker	10	24"	111212115	F, M, IC	3½"	—	—	309.99
MONSG	10	28"	111220113	F, M, IC	3½"	—	—	339.99
MONSG	10	26"	111220114	F, M, IC	3½"	—	—	339.99
MONSG	10	24"	111220115	F, M, IC	3½"	—	—	339.99
MONBU	10	28"	111219113	F, M, IC	3½"	—	—	339.99
MOINF	10	28"	111257113	F, M, IC	3½"	—	—	339.99
MONBU	10	26"	111219114	F, M, IC	3½"	—	—	339.99
MOINF	10	26"	111257114	F, M, IC	3½"	—	—	339.99
MONBU	10	24"	111219115	XF Turkey	3½"	—	—	339.99
MOINF	10	24"	111257115	XF Turkey	3½"	—	—	339.99
MODB	10	28"	111243113	F, M, IC	3½"	—	—	339.99
MODB	10	26"	111243114	F, M, IC	3½"	—	—	339.99
12 GAUGE CAMOUFLAGE								
MONBU	12	28"	111219204	F, M, IC	3½"	—	—	\$339.99
MOINF	12	28"	111257204	F, M, IC	3½"	—	—	339.99
MONBU	12	26"	111219205	F, M, IC	3½"	—	—	339.99
MOINF	12	26"	111257205	F, M, IC	3½"	—	—	339.99
MOINF	12	24"	111257206	XF Turkey	3½"	—	—	339.99
MONSG	12	26"	111220205	F, M, IC	3½"	—	—	339.99
MONSG	12	24"	111220206	F, M, IC	3½"	—	—	339.99
MODB	12	28"	111243204	F, M, IC	3½"	—	—	339.99
MODB	12	26"	111243205	F, M, IC	3½"	—	—	339.99
MONBU	12	28"	111219304	F, M, IC	3"	—	—	299.99
MOINF	12	28"	111257304	F, M, IC	3"	—	—	299.99
MOINF	12	26"	111257305	F, M, IC	3"	—	—	299.99
MOINF	12	24"	111257306	XF Turkey	3"	—	—	299.99
MONSG	12	28"	111220304	F, M, IC	3"	—	—	299.99
MONSG	12	26"	111220305	F, M, IC	3"	—	—	299.99
MONSG	12	24"	111220306	F, M, IC	3"	—	—	299.99
MODB	12	28"	111243304	F, M, IC	3"	—	—	299.99
MODB	12	26"	111243305	F, M, IC	3"	—	—	299.99
12 GAUGE, 16 GAUGE, 20 GAUGE, 28 GAUGE & .410 BORE								
Hunter	12	28"	111211204	F, M, IC	3½"	—	—	\$309.99
Hunter	12	26"	111211205	F, M, IC	3½"	—	—	309.99
Hunter	12	24"	111211206	F, M, IC	3½"	—	—	309.99
Hunter	12	28"	111211304	F, M, IC	3"	—	—	269.99
Hunter	12	26"	111211305	F, M, IC	3"	—	—	269.99
Hunter	12	24"	111211306	F, M, IC	3"	—	—	269.99
Hunter	16	28"	111211513	F, M, IC	2¾"	—	—	269.99
Hunter	16	26"	111211514	F, M, IC	2¾"	—	—	269.99
Hunter	20	28"	111211604	F, M, IC	3"	—	—	269.99
Hunter	20	26"	111211605	F, M, IC	3"	—	—	269.99
Hunter	20	22"	111211607	F, M, IC	3"	—	—	269.99
Hunter	28	28"	111211813	F, M, IC	2¾"	—	—	269.99
Hunter	28	26"	111211814	F, M, IC	2¾"	—	—	269.99
Hunter	.410	26"	111211914	F, M, IC	3"	—	—	269.99
Stalker	12	28"	111212204	F, M, IC	3½"	—	—	309.99
Stalker	12	26"	111212205	F, M, IC	3½"	—	—	309.99
Stalker	12	24"	111212206	F, M, IC	3½"	—	—	309.99
Stalker	12	30"	111212303	F, M, IC	3"	—	—	269.99
Stalker	12	28"	111212304	F, M, IC	3"	—	—	269.99
Stalker	12	26"	111212305	F, M, IC	3"	—	—	269.99
Stalker	12	24"	111212306	F, M, IC	3"	—	—	269.99
Upland Special	12	22"	111216307	F, M, IC	3"	—	—	269.99
GAME GUN								
Deer Special	12	22"	111214221	Rif. Bbl./Cant.	3½"	Satin, Cantilever scope mount	1 in 28"	\$439.99
Deer Special	20	22"	111214621	Rif. Bbl./Cant.	3"	Satin, Cantilever scope mount	1 in 24"	399.99
Deer Special	12	22"	111214324	Rif. Bbl./Cant.	3"	Satin, Cantilever scope mount	1 in 28"	399.99
Turkey Special	12	20½"	111215323	XF Turkey	3"	Satin, with Sight	—	319.99
Turkey Special	12	20½"	111215223	XF Turkey	3½"	Satin, with Sight	—	359.99

IMPORTANT: DO NOT ATTEMPT THE USE OF 3½" CHAMBERED BARRELS WITH 3" RECEIVERS NOR 3" CHAMBERED BARRELS WITH 3½" RECEIVERS.

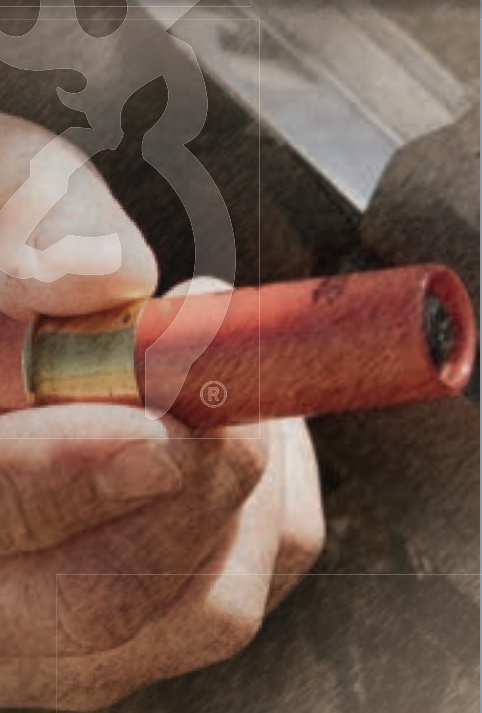

PERFORMANCE

The smooth, anti-bind performance of our A-Bolt centerfire rifles is also found in the A-Bolt Shotgun action.



BARREL

The A-Bolt Shotgun features a fully rifled 1 in 28" twist barrel designed exclusively for use with sabot-type slugs. You can expect superb accuracy with the A-Bolt shotgun — 1 1/2" groups or better are typical at 100 yards.



RUGGED AND ACCURATE.

If shotguns and sabots are big game necessities where you live, now is the time to experience the feel and accuracy of a bolt-action shotgun for whitetail hunting. Browning A-Bolt Shotguns look, handle and feel like our venerable A-Bolt rifle with the same fast-cycling 60° bolt lift, easy-to-reach top-tang safety, detachable box magazine and sweet trigger feel. An adjustable rear sight and fiber-optic front sight are included, plus the receiver is tapped for scope mounts. Want hard-hitting accuracy from a shotgun? Start shooting the A-Bolt Shotgun today.



DETACHABLE MAGAZINE

A detachable magazine on a hinged floorplate allows you to quickly reload. Extra magazines can be carried for fast reloading. (Two shell capacity.)



STOCK

The rugged composite stock features the familiar right-hand palm-swell pistol-grip of the A-Bolt rifle. Checkered gripping surfaces and Dura-Touch® Armor Coating provide security in all conditions.





A-BOLT SHOTGUN HUNTER GAUGE: 12 | SATIN FINISH STOCK

RECEIVER Steel • Low-luster blued finish • Drilled and tapped for scope mounts **BARREL** Low-luster blued finish **ACTION** 3" chamber • Bolt-action • 60° bolt lift • Detachable two-round magazine • Top-tang safety **STOCK** Satin finish walnut • Checkered **FEATURES** Sling swivel studs installed • Recoil pad • TRUGLO®/Marble's® fiber-optic front sight • Rear sight is adjustable for windage and elevation



A-BOLT SHOTGUN STALKER

GAUGE: 12 | DURA-TOUCH® ARMOR COATING ON STOCK

RECEIVER Steel • Low-luster blued finish • Drilled and tapped for scope mounts **BARREL** Low-luster blued finish **ACTION** 3" chamber • Bolt-action • 60° bolt lift • Detachable two-round magazine • Top-tang safety **STOCK** Composite • Checkered gripping surfaces • Dura-Touch® Armor Coating **FEATURES** Sling swivel studs installed • Recoil pad • TRUGLO®/Marble's® fiber-optic front sight • Rear sight is adjustable for windage and elevation

DURA-TOUCH®
Armor Coating



A-BOLT SHOTGUN, MOSSY OAK® BREAK-UP INFINITY®

GAUGE: 12 | DURA-TOUCH® ARMOR COATING ON STOCK

RECEIVER Steel • Low-luster blued finish • Drilled and tapped for scope mounts **BARREL** Low-luster blued finish **ACTION** 3" chamber • Bolt-action • 60° bolt lift • Detachable two-round magazine • Top-tang safety **STOCK** Composite • Checkered gripping surfaces • Mossy Oak® Break-Up Infinity® camo finish • Dura-Touch® Armor Coating **FEATURES** Sling swivel studs installed • Recoil pad • TRUGLO®/Marble's® fiber-optic front sight • Rear sight is adjustable for windage and elevation



DURA-TOUCH®
Armor Coating

GA.	BARREL LENGTH	CODE NUMBER	CHAMBER	*AVG. WEIGHT	OVERALL LENGTH	SIGHT RADIUS	DROP AT COMB	DROP AT HEEL	LENGTH OF PULL	RATE OF TWIST	SUGG. RETAIL
A-BOLT SHOTGUN HUNTER											
12	22"	015001120	3"	7 lbs. 2 oz.	43¾"	15¾"	5/8"	½"	14"	1 in 28"	\$1,269.99
A-BOLT SHOTGUN STALKER											
12	22"	015003120	3"	7 lbs.	43¾"	15¾"	5/8"	½"	14"	1 in 28"	\$1,159.99
A-BOLT SHOTGUN, MOSSY OAK BREAK-UP INFINITY											
12	22"	015005120	3"	7 lbs.	43¾"	15¾"	5/8"	½"	14"	1 in 28"	\$1,299.99

MICRO MIDAS — SHORT ON NOTHING BUT SIZE.

Browning Micro Midas guns are built to our highest quality standards and sized to fit smaller shooters perfectly in every way. Compact Micro Midas models feature shorter lengths of pull and are slimmer and trimmer to comfortably accommodate smaller hands and shorter finger to trigger reach. All Micro Midas firearms are backed-up by the Growth Insurance Program that allows owners to buy full-sized stocks at a great discount should the need arise. It's a guarantee that these little Brownings won't soon be outgrown.

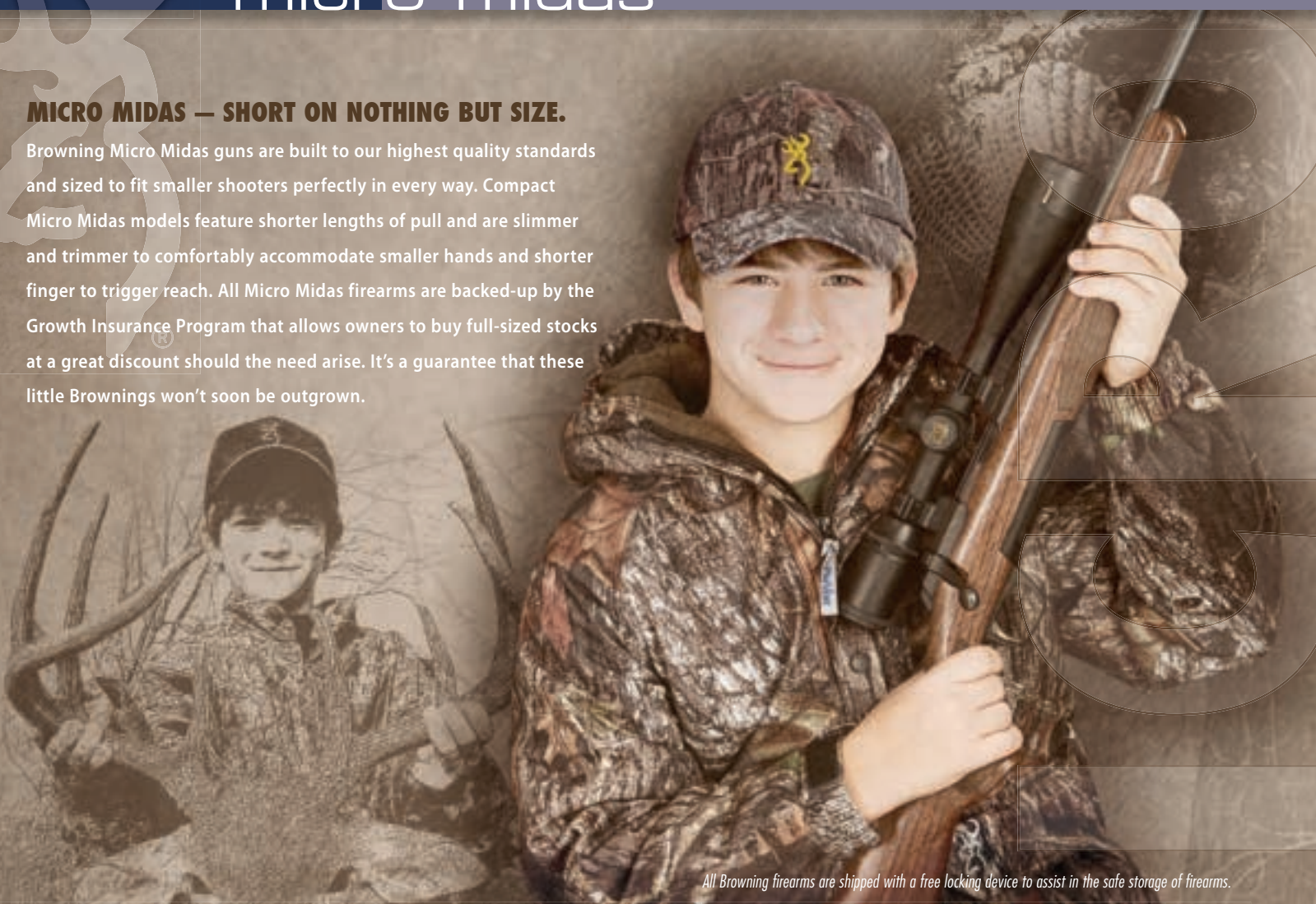

All Browning firearms are shipped with a free locking device to assist in the safe storage of firearms.

Eligible for the Growth Insurance Program. See below for details.



CITORI SATIN HUNTER MICRO MIDAS

GAUGE: 12 (SHOWN), 20 | SATIN FINISH STOCK AND FOREARM

RECEIVER Steel • Blued finish **BARREL** Ventilated rib **ACTION** Single selective trigger • Hammer ejectors • Top-tang barrel selector/safety **STOCK** Satin finish walnut • Compact stock with 13" length of pull **FEATURES** Vector Pro™ lengthened forcing cone • Three Invector-Plus™ choke tubes • Recoil pad on 12 gauge model • Ivory front bead sight

GA.	BARREL LENGTH	CODE NUMBER	CHOKES INCLUDED	CHAMBER	*AVG. WEIGHT	OVERALL LENGTH	DROP AT COMB	DROP AT HEEL	LENGTH OF PULL	RIB WIDTH	SUGG. RETAIL
12	26"	013497305	F, M, IC	3"	7 lbs. 12 oz.	41 ³ / ₄ "	1 ⁵ / ₈ "	2 ¹ / ₂ "	13"	5 ¹ / ₈ "	\$1,599.99
12	24"	013497306	F, M, IC	3"	7 lbs. 10 oz.	39 ³ / ₄ "	1 ⁵ / ₈ "	2 ¹ / ₂ "	13"	5 ¹ / ₈ "	1,599.99
20	26"	013497605	F, M, IC	3"	6 lbs. 1 oz.	41 ³ / ₄ "	1 ¹ / ₂ "	2 ³ / ₈ "	13"	1 ¹ / ₄ "	1,599.99
20	24"	013497606	F, M, IC	3"	5 lbs. 15 oz.	39 ³ / ₄ "	1 ¹ / ₂ "	2 ³ / ₈ "	13"	1 ¹ / ₄ "	1,599.99

*NOTE: Weights listed are approximate.

BROWNING GROWTH INSURANCE PROGRAM

Purchasing a firearm for a growing shooter is a tough decision to make. You can choose an inexpensive "youth" model with questionable quality that will soon be outgrown. Or you can buy a quality adult-size firearm they can "grow into" but may prevent them from reaching their shooting potential because of poor fit. We offer the perfect solution with the Growth Insurance Program. Purchase a new Browning Micro Midas or Micro firearm and you are eligible to purchase a full-size stock at 50% off the retail price down the road. That's a big savings for you, and it allows the shooter to enjoy a firearm of the highest quality that is sure to fit and maximize their shooting performance and enjoyment, both now and for years to come. Visit browning.com for complete details.



micro midas

Eligible for the Growth Insurance Program. See page 54 for details.



SILVER HUNTER MICRO MIDAS

GAUGE: 12 (SHOWN), 20 | SATIN FINISH STOCK AND FOREARM

RECEIVER Strong, lightweight aluminum alloy • Semi-humpback design
 • Silver finish **BARREL** Lightweight profile • Ventilated rib **ACTION** Gas-operated autoloader • 3" chamber • Active Valve System reliably cycles a wide range of loads **STOCK** Satin finish walnut • Compact 13" length of pull for smaller shooters **FEATURES** Three Invector-Plus™ choke tubes • Ivory front bead sight
 • Recoil pad • One ¼" stock spacer

GA.	BARREL LENGTH	CODE NUMBER	CHOKES INCLUDED	CHAMBER	*AVG. WEIGHT	OVERALL LENGTH	DROP AT COMB	DROP AT HEEL	LENGTH OF PULL	RIB WIDTH	SUGG. RETAIL
12	26"	011389305	F, M, IC	3"	7 lbs. 5 oz.	45¾"	1½"	1¾"	13"	¼"	\$1,179.99
12	24"	011389306	F, M, IC	3"	7 lbs. 3 oz.	43¾"	1½"	1¾"	13"	¼"	1,179.99
20	26"	011389605	F, M, IC	3"	6 lbs. 2 oz.	45¾"	1½"	1¾"	13"	¼"	1,179.99
20	24"	011389606	F, M, IC	3"	6 lbs.	43¾"	1½"	1¾"	13"	¼"	1,179.99

*NOTE: Weights listed are approximate.



Eligible for the Growth Insurance Program. See page 54 for details.

X-BOLT MICRO MIDAS SATIN FINISH STOCK

RECEIVER Steel • Low-luster blued finish • Glass bedded • Drilled and tapped for scope mounts **BARREL** Low-luster blued finish • Free-floating • Hand chambered • Target crown **ACTION** Bolt-action • 60° bolt lift • Adjustable Feather Trigger™ • Detachable rotary magazine • Top-tang safety • Bolt unlock button **STOCK** Satin finish checkered walnut • Compact 12½" length of pull for smaller shooters **FEATURES** Sling swivel studs installed • Inflex Technology recoil pad (Scope and mounts not included)



(SSA) = Super-Short Action, (SA) = Short Action

CALIBER	BARREL LENGTH	CODE NUMBER	*TOTAL CAPACITY	**AVG. WEIGHT	OVERALL LENGTH	SIGHT RADIUS	***DROP AT COMB	DROP AT HEEL	LENGTH OF PULL	RATE OF TWIST	SUGG. RETAIL
(SSA) 22-250 Rem.	20"	035249209	5	6 lbs. 1 oz.	37¾"	—	1¼"	½"	12½"	1 in 14"	\$839.99
(SA) 243 Win.	20"	035248211	5	6 lbs. 1 oz.	38¾"	—	1¼"	½"	12½"	1 in 10"	839.99
(SA) 7mm-08 Rem.	20"	035248216	5	6 lbs. 1 oz.	38¾"	—	1¼"	½"	12½"	1 in 9½"	839.99
(SA) 308 Win.	20"	035248218	5	6 lbs. 1 oz.	38¾"	—	1¼"	½"	12½"	1 in 12"	839.99

NOTE: *Total capacity includes one round in the chamber. **Weights listed are approximate. ***Measured from centerline of bore.

Eligible for the Growth Insurance Program. See page 54 for details.



BL-22 GRADE I MICRO MIDAS

GLOSS FINISH STOCK AND FOREARM

RECEIVER Steel • Blued finish • Grooved for scope mounts **BARREL** Blued finish • Recessed crown **ACTION** Lever-action • Short 33° throw • Tubular magazine **STOCK** Gloss finish, checkered American walnut • Straight grip • Compact 12" length of pull for smaller shooters **FEATURES** Adjustable sights

CALIBER	BARREL LENGTH	CODE NUMBER	*TOTAL CAPACITY	**AVG. WEIGHT	OVERALL LENGTH	SIGHT RADIUS	***DROP AT COMB	DROP AT HEEL	LENGTH OF PULL	RATE OF TWIST	SUGG. RETAIL
22 L.R.	16¼"	024115103	12	4 lbs. 12 oz.	31½"	11¾"	7"	1½"	12"	1 in 16"	\$539.99

NOTE: *Total capacity includes one round in the chamber. **Weights listed are approximate. ***Measured from centerline of bore.



SYSTEM INTEGRATION FOR TOTAL ACCURACY.

From the start, the Browning X-Bolt was designed as an integrated system with the goal of delivering tack-driving accuracy. A long list of innovative features, time-tested quality and straight-from-the-box accuracy ensure that the X-Bolt will deliver for you on your next whitetail, elk or varmint hunt.

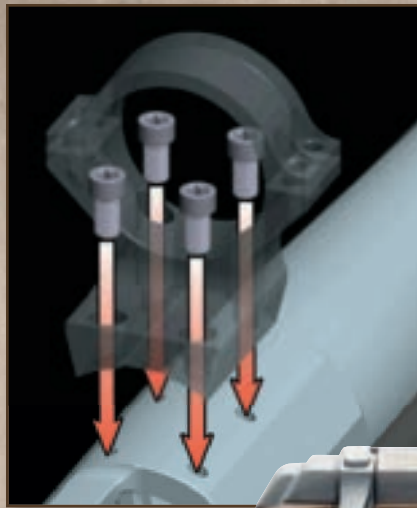

X-LOCK™ SCOPE MOUNTING SYSTEM

Securely mounted optics are essential for accuracy and precision on any rifle. To ensure the X-Bolt has the most stable scope mounting system possible, X-Lock mounts feature a four screw per base design that replaces the traditional two screw system. With the bases secured at all four corners, you get more accurate placement and more secure attachment to the receiver. See page 143 for more details on the new X-Lock Scope Mounting System.



X-BOLT WHITE GOLD GLOSS FINISH STOCK

- RECEIVER** Stainless steel • Polished finish • Glass bedded • Drilled and tapped for scope mounts • Scroll engraving on front and rear receiver
- BARREL** Stainless steel • Polished stainless finish • Free-floating
- Hand chambered • Target crown **ACTION** Bolt-action • 60° bolt lift
- Adjustable Feather Trigger™ • Detachable rotary magazine
- Top-tang safety • Bolt unlock button **STOCK** Gloss finish checkered walnut • Rosewood fore-end grip and pistol grip cap **FEATURES** Sling swivel studs installed • Sling swivels included • Inflex Technology recoil pad

INFLEX TECHNOLOGY RECOIL PAD

The Inflex Technology recoil pad is standard on every X-Bolt rifle. This ultra soft pad offers the best recoil absorption available on any rifle. The proprietary construction and material promote a directional deflection of recoil forces, pulling the stock comb away from your face to reduce felt recoil and muzzle climb.

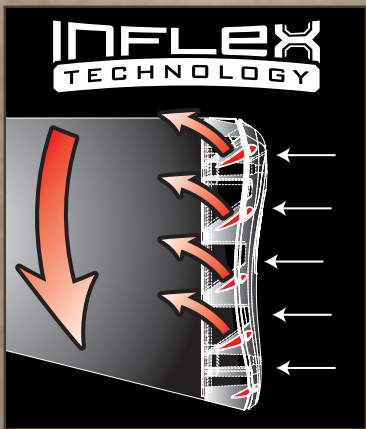



Eligible for the Growth Insurance program. See page 54 for details.



X-BOLT MICRO MIDAS SATIN FINISH STOCK

RECEIVER Steel • Low-luster blued finish • Glass bedded • Drilled and tapped for scope mounts **BARREL** Low-luster blued finish • Free-floating • Hand chambered • Target crown **ACTION** Bolt-action • 60° bolt lift • Adjustable Feather Trigger™ • Detachable rotary magazine • Top-tang safety • Bolt unlock button **STOCK** Satin finish checkered walnut • Compact 12½" length of pull for smaller shooters **FEATURES** Sling swivel studs installed • Inflex Technology recoil pad (Scope and mounts not included)



FEATHER TRIGGER™

For precise shooting there is absolutely no substitute for a crisp, predictable trigger. The X-Bolt's three-lever Feather Trigger™ provides a clean, crisp pull with no take-up or creep and minimal overtravel. The trigger is screw adjustable from 3 to 5 lbs. and factory pre-set at approximately 3½ lbs. An alloy trigger housing contains hard chromed steel components that are highly polished on all critical contact surfaces. Precise engagement angles mean the X-Bolt Feather Trigger feels light and stays that way through many thousands of rounds. Unlike competitors' triggers that rely on a secondary finger piece lever, the Feather Trigger was designed right, from the very start.

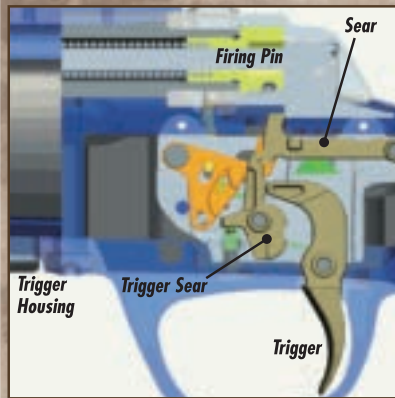

Full sear engagement (Ready to fire)

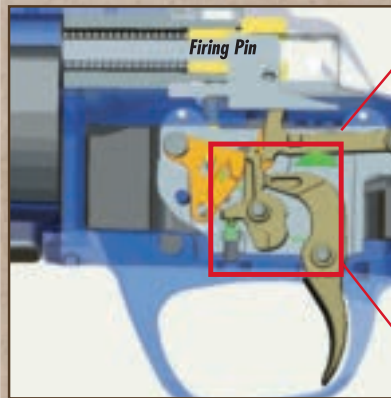

Unseared (Fired)

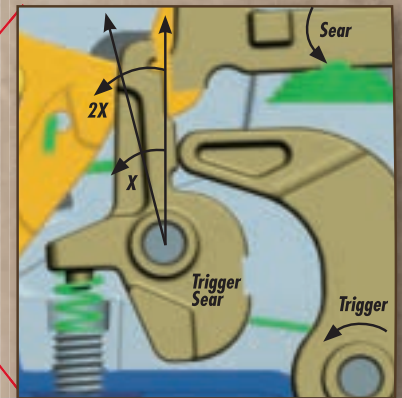

Close-up of unseared (Fired)

(SSA) = Super-Short Action, (SA) = Short Action, (LA) = Long Action

CALIBER	BARREL LENGTH	CODE NUMBER	*TOTAL CAPACITY	**AVG. WEIGHT	OVERALL LENGTH	SIGHT RADIUS	***DROP AT COMB	DROP AT HEEL	LENGTH OF PULL	RATE OF TWIST	SUGG. RETAIL
X-BOLT MICRO MIDAS											
(SSA) 22-250 Rem.	20"	035249209	5	6 lbs. 1 oz.	38½"	—	1¼"	½"	12½"	1 in 14"	\$839.99
(SA) 243 Win.	20"	035248211	5	6 lbs. 1 oz.	38½"	—	1¼"	½"	12½"	1 in 10"	839.99
(SA) 7mm-08 Rem.	20"	035248216	5	6 lbs. 1 oz.	38½"	—	1¼"	½"	12½"	1 in 9½"	839.99
(SA) 308 Win.	20"	035248218	5	6 lbs. 1 oz.	38½"	—	1¼"	½"	12½"	1 in 12"	839.99
X-BOLT WHITE GOLD											
(SSA) 223 Rem.	22"	035251208	6	6 lbs. 6 oz.	41¼"	—	¾"	1½"	13½"	1 in 12"	\$1,399.99
(SSA) 22-250 Rem.	22"	035251209	5	6 lbs. 6 oz.	41¼"	—	¾"	1½"	13½"	1 in 14"	1,399.99
(SA) 243 Win.	22"	035235211	5	6 lbs. 8 oz.	41¾"	—	¾"	1½"	13½"	1 in 10"	1,399.99
(SA) 7mm-08 Rem.	22"	035235216	5	6 lbs. 8 oz.	41¾"	—	¾"	1½"	13½"	1 in 9½"	1,399.99
(SA) 308 Win.	22"	035235218	5	6 lbs. 8 oz.	41¾"	—	¾"	1½"	13½"	1 in 12"	1,399.99
(SA) 270 WSM	23"	035235248	4	6 lbs. 11 oz.	42¾"	—	¾"	1½"	13½"	1 in 10"	1,439.99
(SA) 7mm WSM	23"	035235249	4	6 lbs. 11 oz.	42¾"	—	¾"	1½"	13½"	1 in 9½"	1,439.99
(SA) 300 WSM	23"	035235246	4	6 lbs. 11 oz.	42¾"	—	¾"	1½"	13½"	1 in 10"	1,439.99
(SA) 325 WSM	23"	035235277	4	6 lbs. 11 oz.	42¾"	—	¾"	1½"	13½"	1 in 10"	1,439.99
(LA) 25-06 Rem.	24"	035235223	5	6 lbs. 14 oz.	44¾"	—	¾"	1½"	13½"	1 in 10"	1,399.99
(LA) 270 Win.	22"	035235224	5	6 lbs. 12 oz.	42¾"	—	¾"	1½"	13½"	1 in 10"	1,399.99
(LA) 280 Rem.	22"	035235225	5	6 lbs. 12 oz.	42¾"	—	¾"	1½"	13½"	1 in 10"	1,399.99
(LA) 30-06 Sprg.	22"	035235226	5	6 lbs. 12 oz.	42¾"	—	¾"	1½"	13½"	1 in 10"	1,399.99
(LA) 7mm Rem. Mag.	26"	035235227	4	7 lbs.	46¾"	—	¾"	1½"	13½"	1 in 9½"	1,439.99
(LA) 300 Win. Mag.	26"	035235229	4	7 lbs.	46¾"	—	¾"	1½"	13½"	1 in 10"	1,439.99
(LA) 338 Win. Mag.	26"	035235231	4	7 lbs.	46¾"	—	¾"	1½"	13½"	1 in 10"	1,439.99

NOTE: *Total capacity includes one round in the chamber. **Weights listed are approximate. ***Measured from centerline of bore.

THE X-BOLT — A PRECISION RIFLE FOR DISCRIMINATING MARKSMEN.

With a Browning X-Bolt you get more than total accuracy, you also get total quality. Medallion and Hunter rifles feature top-notch fit, finish and stock checkering. The receiver is carefully bedded into the stock to ensure no forces that could hinder accuracy act upon the barrel. Touches like these are what elevate the X-Bolt above the competition.



60° BOLT LIFT

Short 60° bolt lift is fast cycling and allows you to work the bolt quickly without the scope getting in the way. The bolt is machined from solid steel bar stock for strength and custom rifle precision. Three locking lugs provide exceptional bolt strength.



X-BOLT MEDALLION GLOSS FINISH STOCK

RECEIVER Steel • Engraved with blued finish • Glass bedded • Drilled and tapped for scope mounts **BARREL** Blued finish • Free-floating • Hand chambered • Target crown **ACTION** Bolt-action • 60° bolt lift • Adjustable Feather Trigger™ • Detachable rotary magazine • Top-tang safety • Bolt unlock button **STOCK** Gloss finish checkered walnut • Rosewood fore-end grip and pistol grip cap **FEATURES** Sling swivel studs installed • Inflex Technology recoil pad



(SSA) = Super-Short Action, (SA) = Short Action, (LA) = Long Action

	CALIBER	BARREL LENGTH	CODE NUMBER	*TOTAL CAPACITY	**AVG. WEIGHT	OVERALL LENGTH	SIGHT RADIUS	***DROP AT COMB	DROP AT HEEL	LENGTH OF PULL	RATE OF TWIST	SUGG. RETAIL
X-BOLT MEDALLION (SHOWN)												
	(SSA) 223 Rem.	22"	035204208	6	6 lbs. 6 oz.	41¼"	—	1¼"	½"	13¾"	1 in 12"	\$1,029.99
	(SSA) 22-250 Rem.	22"	035204209	5	6 lbs. 6 oz.	41¼"	—	1¼"	½"	13¾"	1 in 14"	1,029.99
	(SA) 243 Win.	22"	035200211	5	6 lbs. 8 oz.	41¾"	—	1¼"	½"	13¾"	1 in 10"	1,029.99
	(SA) 308 Win.	22"	035200218	5	6 lbs. 8 oz.	41¾"	—	1¼"	½"	13¾"	1 in 12"	1,029.99
	(SA) 270 WSM	23"	035200248	4	6 lbs. 11 oz.	42¾"	—	1¼"	½"	13¾"	1 in 10"	1,069.99
	(SA) 7mm WSM	23"	035200249	4	6 lbs. 11 oz.	42¾"	—	1¼"	½"	13¾"	1 in 9½"	1,069.99
	(SA) 300 WSM	23"	035200246	4	6 lbs. 11 oz.	42¾"	—	1¼"	½"	13¾"	1 in 10"	1,069.99
	(SA) 325 WSM	23"	035200277	4	6 lbs. 11 oz.	42¾"	—	1¼"	½"	13¾"	1 in 10"	1,069.99
	(LA) 25-06 Rem.	24"	035200223	5	6 lbs. 14 oz.	44¾"	—	1¼"	½"	13¾"	1 in 10"	1,029.99
	(LA) 270 Win.	22"	035200224	5	6 lbs. 12 oz.	42¾"	—	1¼"	½"	13¾"	1 in 10"	1,029.99
	(LA) 280 Rem.	22"	035200225	5	6 lbs. 12 oz.	42¾"	—	1¼"	½"	13¾"	1 in 10"	1,029.99
	(LA) 30-06 Sprg.	22"	035200226	5	6 lbs. 12 oz.	42¾"	—	1¼"	½"	13¾"	1 in 10"	1,029.99
	(LA) 7mm Rem. Mag.	26"	035200227	4	7 lbs.	46¾"	—	1¼"	½"	13¾"	1 in 9½"	1,069.99
	(LA) 300 Win. Mag.	26"	035200229	4	7 lbs.	46¾"	—	1¼"	½"	13¾"	1 in 10"	1,069.99
	(LA) 338 Win. Mag.	26"	035200231	4	7 lbs.	46¾"	—	1¼"	½"	13¾"	1 in 10"	1,069.99
NEW	(LA) 375 H&H Mag. (open sights)	24"	035200132	4	7 lbs.	46¾"	18"	1¼"	½"	13¾"	1 in 12"	1,069.99
X-BOLT MEDALLION, LEFT-HAND												
	(SSA) 223 Rem.	22"	035252208	6	6 lbs. 6 oz.	41¼"	—	1¼"	½"	13¾"	1 in 12"	\$1,059.99
	(SSA) 22-250 Rem.	22"	035252209	5	6 lbs. 6 oz.	41¼"	—	1¼"	½"	13¾"	1 in 14"	1,059.99
	(SA) 243 Win.	22"	035253211	5	6 lbs. 8 oz.	41¾"	—	1¼"	½"	13¾"	1 in 10"	1,059.99
	(SA) 308 Win.	22"	035253218	5	6 lbs. 8 oz.	41¾"	—	1¼"	½"	13¾"	1 in 12"	1,059.99
	(SA) 270 WSM	23"	035253248	4	6 lbs. 11 oz.	42¾"	—	1¼"	½"	13¾"	1 in 10"	1,099.99
	(SA) 7mm WSM	23"	035253249	4	6 lbs. 11 oz.	42¾"	—	1¼"	½"	13¾"	1 in 9½"	1,099.99
	(SA) 300 WSM	23"	035253246	4	6 lbs. 11 oz.	42¾"	—	1¼"	½"	13¾"	1 in 10"	1,099.99
	(SA) 325 WSM	23"	035253277	4	6 lbs. 11 oz.	42¾"	—	1¼"	½"	13¾"	1 in 10"	1,099.99
	(LA) 25-06 Rem.	24"	035253223	5	6 lbs. 14 oz.	44¾"	—	1¼"	½"	13¾"	1 in 10"	1,059.99
	(LA) 270 Win.	22"	035253224	5	6 lbs. 12 oz.	42¾"	—	1¼"	½"	13¾"	1 in 10"	1,059.99
	(LA) 280 Rem.	22"	035253225	5	6 lbs. 12 oz.	42¾"	—	1¼"	½"	13¾"	1 in 10"	1,059.99
	(LA) 30-06 Sprg.	22"	035253226	5	6 lbs. 12 oz.	42¾"	—	1¼"	½"	13¾"	1 in 10"	1,059.99
	(LA) 7mm Rem. Mag.	26"	035253227	4	7 lbs.	46¾"	—	1¼"	½"	13¾"	1 in 9½"	1,099.99
	(LA) 300 Win. Mag.	26"	035253229	4	7 lbs.	46¾"	—	1¼"	½"	13¾"	1 in 10"	1,099.99
	(LA) 338 Win. Mag.	26"	035253231	4	7 lbs.	46¾"	—	1¼"	½"	13¾"	1 in 10"	1,099.99

NOTE: *Total capacity includes one round in the chamber. **Weights listed are approximate. ***Measured from centerline of bore.

PERFORMANCE WHEN IT MATTERS MOST.

The Browning X-Bolt is a rifle waiting to be called upon to bring down a trophy big game animal. The total accuracy advantage gives you the confidence in the field to make longer shots. Inflex Technology recoil control keeps you on your quarry. Fast-operating 60° bolt lift lets you quickly chamber another round — should you need more than one.

X-BOLT HUNTER SATIN FINISH STOCK

- RECEIVER** Steel • Low-luster blued finish • Glass bedded
- Drilled and tapped for scope mounts **BARREL** Low-luster blued finish • Free-floating • Hand chambered • Target crown
- ACTION** Bolt-action • 60° bolt lift • Adjustable Feather Trigger™ • Detachable rotary magazine • Top-tang safety
- Bolt unlock button **STOCK** Satin finish checkered walnut
- FEATURES** Sling swivel studs installed • Inflex Technology recoil pad (Scope and mounts not included)



BARREL

A free-floating barrel is essential for utmost accuracy. The X-Bolt is free-floated by bedding the front and rear of the action for stability. This maintains barrel to stock spacing for consistent accuracy. A recessed muzzle crown helps protect the rifling from damage. Barrels are triple checked for interior finish, straightness and air-gauged for uniformity.



BOLT UNLOCK BUTTON

Conveniently located on top of the bolt handle, the bolt unlock button allows the bolt to be unlocked and opened with the safety in the on safe position. The bolt unlock button works in conjunction with the top-tang safety to provide an extra margin of safety when checking and unloading the chamber. The safety blocks the trigger sear and features a firing pin block for added security.

(SSA) = Super-Short Action, (SA) = Short Action, (LA) = Long Action

	CALIBER	BARREL LENGTH	CODE NUMBER	*TOTAL CAPACITY	**AVG. WEIGHT	OVERALL LENGTH	SIGHT RADIUS	***DROP AT COMB	DROP AT HEEL	LENGTH OF PULL	RATE OF TWIST	SUGG. RETAIL
X-BOLT HUNTER (SHOWN)												
	(SSA) 223 Rem.	22"	035209208	6	6 lbs. 6 oz.	41 1/4"	—	1 1/16"	1/2"	13 3/8"	1 in 12"	\$899.99
	(SSA) 22-250 Rem.	22"	035209209	5	6 lbs. 6 oz.	41 1/4"	—	1 1/16"	1/2"	13 3/8"	1 in 14"	899.99
	(SA) 243 Win.	22"	035208211	5	6 lbs. 8 oz.	41 3/4"	—	1 1/16"	1/2"	13 3/8"	1 in 10"	899.99
	(SA) 7mm-08 Rem.	22"	035208216	5	6 lbs. 8 oz.	41 3/4"	—	1 1/16"	1/2"	13 3/8"	1 in 9 1/2"	899.99
	(SA) 308 Win.	22"	035208218	5	6 lbs. 8 oz.	41 3/4"	—	1 1/16"	1/2"	13 3/8"	1 in 12"	899.99
	(SA) 270 WSM	23"	035208248	4	6 lbs. 11 oz.	42 3/4"	—	1 1/16"	1/2"	13 3/8"	1 in 10"	939.99
	(SA) 7mm WSM	23"	035208249	4	6 lbs. 11 oz.	42 3/4"	—	1 1/16"	1/2"	13 3/8"	1 in 9 1/2"	939.99
	(SA) 300 WSM	23"	035208246	4	6 lbs. 11 oz.	42 3/4"	—	1 1/16"	1/2"	13 3/8"	1 in 10"	939.99
	(SA) 325 WSM	23"	035208277	4	6 lbs. 11 oz.	42 3/4"	—	1 1/16"	1/2"	13 3/8"	1 in 10"	939.99
	(LA) 25-06 Rem.	24"	035208223	5	6 lbs. 14 oz.	44 3/4"	—	1 1/16"	1/2"	13 3/8"	1 in 10"	899.99
	(LA) 270 Win.	22"	035208224	5	6 lbs. 12 oz.	42 3/4"	—	1 1/16"	1/2"	13 3/8"	1 in 10"	899.99
	(LA) 280 Rem.	22"	035208225	5	6 lbs. 12 oz.	42 3/4"	—	1 1/16"	1/2"	13 3/8"	1 in 10"	899.99
	(LA) 30-06 Sprg.	22"	035208226	5	6 lbs. 12 oz.	42 3/4"	—	1 1/16"	1/2"	13 3/8"	1 in 10"	899.99
	(LA) 7mm Rem. Mag.	26"	035208227	4	7 lbs.	46 3/4"	—	1 1/16"	1/2"	13 3/8"	1 in 9 1/2"	939.99
	(LA) 300 Win. Mag.	26"	035208229	4	7 lbs.	46 3/4"	—	1 1/16"	1/2"	13 3/8"	1 in 10"	939.99
	(LA) 338 Win. Mag.	26"	035208231	4	7 lbs.	46 3/4"	—	1 1/16"	1/2"	13 3/8"	1 in 10"	939.99
NEW	(LA) 375 H&H Mag. (open sights)	24"	035208132	4	7 lbs.	46 3/4"	18"	1 1/16"	1/2"	13 3/8"	1 in 12"	939.99
X-BOLT HUNTER, LEFT-HAND												
	(SSA) 223 Rem.	22"	035254208	6	6 lbs. 6 oz.	41 1/4"	—	1 1/16"	1/2"	13 3/8"	1 in 12"	\$919.99
	(SSA) 22-250 Rem.	22"	035254209	5	6 lbs. 6 oz.	41 1/4"	—	1 1/16"	1/2"	13 3/8"	1 in 14"	919.99
	(SA) 243 Win.	22"	035255211	5	6 lbs. 8 oz.	41 3/4"	—	1 1/16"	1/2"	13 3/8"	1 in 10"	919.99
	(SA) 7mm-08 Rem.	22"	035255216	5	6 lbs. 8 oz.	41 3/4"	—	1 1/16"	1/2"	13 3/8"	1 in 9 1/2"	919.99
	(SA) 308 Win.	22"	035255218	5	6 lbs. 8 oz.	41 3/4"	—	1 1/16"	1/2"	13 3/8"	1 in 12"	919.99
	(SA) 270 WSM	23"	035255248	4	6 lbs. 11 oz.	42 3/4"	—	1 1/16"	1/2"	13 3/8"	1 in 10"	959.99
	(SA) 7mm WSM	23"	035255249	4	6 lbs. 11 oz.	42 3/4"	—	1 1/16"	1/2"	13 3/8"	1 in 9 1/2"	959.99
	(SA) 300 WSM	23"	035255246	4	6 lbs. 11 oz.	42 3/4"	—	1 1/16"	1/2"	13 3/8"	1 in 10"	959.99
	(SA) 325 WSM	23"	035255277	4	6 lbs. 11 oz.	42 3/4"	—	1 1/16"	1/2"	13 3/8"	1 in 10"	959.99
	(LA) 25-06 Rem.	24"	035255223	5	6 lbs. 14 oz.	44 3/4"	—	1 1/16"	1/2"	13 3/8"	1 in 10"	919.99
	(LA) 270 Win.	22"	035255224	5	6 lbs. 12 oz.	42 3/4"	—	1 1/16"	1/2"	13 3/8"	1 in 10"	919.99
	(LA) 280 Rem.	22"	035255225	5	6 lbs. 12 oz.	42 3/4"	—	1 1/16"	1/2"	13 3/8"	1 in 10"	919.99
	(LA) 30-06 Sprg.	22"	035255226	5	6 lbs. 12 oz.	42 3/4"	—	1 1/16"	1/2"	13 3/8"	1 in 10"	919.99
	(LA) 7mm Rem. Mag.	26"	035255227	4	7 lbs.	46 3/4"	—	1 1/16"	1/2"	13 3/8"	1 in 9 1/2"	959.99
	(LA) 300 Win. Mag.	26"	035255229	4	7 lbs.	46 3/4"	—	1 1/16"	1/2"	13 3/8"	1 in 10"	959.99
	(LA) 338 Win. Mag.	26"	035255231	4	7 lbs.	46 3/4"	—	1 1/16"	1/2"	13 3/8"	1 in 10"	959.99

NOTE: *Total capacity includes one round in the chamber. **Weights listed are approximate. ***Measured from centerline of bore.

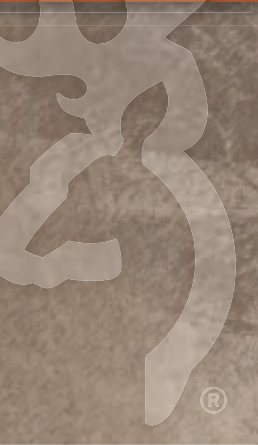

X-BOLT MICRO HUNTER SATIN FINISH STOCK

RECEIVER Steel • Low-luster blued finish • Glass bedded
 • Drilled and tapped for scope mounts **BARREL** Low-luster blued finish • Free-floating • Hand chambered • Target crown
ACTION Bolt-action • 60° bolt lift • Adjustable Feather Trigger™
 • Detachable rotary magazine • Top-tang safety • Bolt unlock button **STOCK** Satin finish checkered walnut • Sized for smaller shooters **FEATURES** Sling swivel studs installed • Inflex Technology recoil pad (Scope and mounts not included)



Eligible for the Growth Insurance program. See page 54 for details.



(SSA) = Super-Short Action, (SA) = Short Action

CALIBER	BARREL LENGTH	CODE NUMBER	*TOTAL CAPACITY	**AVG. WEIGHT	OVERALL LENGTH	SIGHT RADIUS	***DROP AT COMB	DROP AT HEEL	LENGTH OF PULL	RATE OF TWIST	SUGG. RETAIL
X-BOLT MICRO HUNTER (SHOWN)											
(SSA) 22-250 Rem.	20"	035216209	5	5 lbs. 15 oz.	39"	—	1 1/16"	1/2"	13 3/8"	1 in 14"	\$899.99
(SA) 243 Win.	20"	035215211	5	6 lbs. 2 oz.	39 1/2"	—	1 1/16"	1/2"	13 3/8"	1 in 10"	899.99
(SA) 7mm-08 Rem.	20"	035215216	5	6 lbs. 2 oz.	39 1/2"	—	1 1/16"	1/2"	13 3/8"	1 in 9 1/2"	899.99
(SA) 308 Win.	20"	035215218	5	6 lbs. 2 oz.	39 1/2"	—	1 1/16"	1/2"	13 3/8"	1 in 12"	899.99
(SA) 270 WSM	22"	035215248	4	6 lbs. 7 oz.	41 1/2"	—	1 1/16"	1/2"	13 3/8"	1 in 10"	939.99
(SA) 7mm WSM	22"	035215249	4	6 lbs. 7 oz.	41 1/2"	—	1 1/16"	1/2"	13 3/8"	1 in 9 1/2"	939.99
(SA) 300 WSM	22"	035215246	4	6 lbs. 7 oz.	41 1/2"	—	1 1/16"	1/2"	13 3/8"	1 in 10"	939.99
(SA) 325 WSM	22"	035215277	4	6 lbs. 7 oz.	41 1/2"	—	1 1/16"	1/2"	13 3/8"	1 in 10"	939.99
X-BOLT MICRO HUNTER, LEFT-HAND											
(SSA) 22-250 Rem.	20"	035256209	5	5 lbs. 15 oz.	39"	—	1 1/16"	1/2"	13 3/8"	1 in 14"	\$919.99
(SA) 243 Win.	20"	035257211	5	6 lbs. 2 oz.	39 1/2"	—	1 1/16"	1/2"	13 3/8"	1 in 10"	919.99
(SA) 7mm-08 Rem.	20"	035257216	5	6 lbs. 2 oz.	39 1/2"	—	1 1/16"	1/2"	13 3/8"	1 in 9 1/2"	919.99
(SA) 308 Win.	20"	035257218	5	6 lbs. 2 oz.	39 1/2"	—	1 1/16"	1/2"	13 3/8"	1 in 12"	919.99
(SA) 270 WSM	22"	035257248	4	6 lbs. 7 oz.	41 1/2"	—	1 1/16"	1/2"	13 3/8"	1 in 10"	959.99
(SA) 7mm WSM	22"	035257249	4	6 lbs. 7 oz.	41 1/2"	—	1 1/16"	1/2"	13 3/8"	1 in 9 1/2"	959.99
(SA) 300 WSM	22"	035257246	4	6 lbs. 7 oz.	41 1/2"	—	1 1/16"	1/2"	13 3/8"	1 in 10"	959.99
(SA) 325 WSM	22"	035257277	4	6 lbs. 7 oz.	41 1/2"	—	1 1/16"	1/2"	13 3/8"	1 in 10"	959.99

NOTE: *Total capacity includes one round in the chamber. **Weights listed are approximate. ***Measured from centerline of bore.

X-BOLT EXTRA MAGAZINES

CALIBER	CODE NUMBER	SUGG. RETAIL
Long Action Magnum: 338 Win. Mag., 300 Win. Mag., 7mm Rem. Mag.	112044601	\$49.99
Long Action Standard: 30-06 Sprg., 280 Rem., 270 Win., 25-06 Rem.	112044602	49.99
Short Action Magnum: 325 WSM, 300 WSM, 7mm WSM, 270 WSM	112044603	49.99
Short Action Standard: 308 Win., 7mm-08 Rem., 243 Win.	112044604	49.99
Super-Short Action Standard: 22-250 Rem.	112044009	49.99
Super-Short Action Standard: 223 Rem.	112044008	49.99
Large Magnum Calibers: 375 H&H Mag.	112044606	49.99



MAGAZINE

The X-Bolt is fed from a detachable rotary magazine constructed from a durable, lightweight polymer. Cartridges are picked up from the center of the magazine, directly in-line with the bolt, instead of offset as with traditional leaf-spring magazines, for a straight shot right into the chamber. An ergonomic magazine-mounted release lets the magazine drop directly downward and into your hand. The magazine sits flush with the bottom of the rifle for a sleek appearance. Additional magazines can be kept loaded and carried for easy access.



X-BOLT COMPOSITE STALKER DURA-TOUCH® ARMOR COATING ON STOCK

RECEIVER Steel • Matte blued finish • Glass bedded • Drilled and tapped for scope mounts **BARREL** Matte blued finish • Free-floating • Hand chambered • Target crown **ACTION** Bolt-action • 60° bolt lift • Adjustable Feather Trigger™ • Detachable rotary magazine • Top-tang safety • Bolt unlock button **STOCK** Composite • Textured gripping surfaces • Palm swell • Matte black • Dura-Touch® Armor Coating **FEATURES** Sling swivel studs installed • Inflex Technology recoil pad (Scope and mounts not included)



X-BOLT STAINLESS STALKER DURA-TOUCH® ARMOR COATING ON STOCK

RECEIVER Stainless steel • Matte finish • Glass bedded • Drilled and tapped for scope mounts **BARREL** Stainless steel • Matte finish • Free-floating • Hand chambered • Target crown **ACTION** Bolt-action • 60° bolt lift • Adjustable Feather Trigger™ • Detachable rotary magazine • Top-tang safety • Bolt unlock button **STOCK** Composite • Textured gripping surfaces • Palm swell • Matte black • Dura-Touch® Armor Coating **FEATURES** Sling swivel studs installed • Inflex Technology recoil pad (Scope and mounts not included)



MAXIMUM GRIP

Composite X-Bolt models combine in-molded textured gripping surfaces and our proven Dura-Touch® Armor Coating for a sure hold and a sleek feel in all climate conditions.

(SSA) = Super-Short Action, (SA) = Short Action, (LA) = Long Action

CALIBER	BARREL LENGTH	CODE NUMBER	*TOTAL CAPACITY	**AVG. WEIGHT	OVERALL LENGTH	SIGHT RADIUS	***DROP AT COMB	DROP AT HEEL	LENGTH OF PULL	RATE OF TWIST	SUGG. RETAIL
X-BOLT COMPOSITE STALKER											
(SSA) 223 Rem.	22"	035205208	6	6 lbs. 3 oz.	41 1/4"	—	1 1/8"	1/2"	13 3/8"	1 in 12"	\$839.99
(SSA) 22-250 Rem.	22"	035205209	5	6 lbs. 3 oz.	41 1/4"	—	1 1/8"	1/2"	13 3/8"	1 in 14"	839.99
(SA) 243 Win.	22"	035201211	5	6 lbs. 5 oz.	41 3/4"	—	1 1/8"	1/2"	13 3/8"	1 in 10"	839.99
(SA) 7mm-08 Rem.	22"	035201216	5	6 lbs. 5 oz.	41 3/4"	—	1 1/8"	1/2"	13 3/8"	1 in 9 1/2"	839.99
(SA) 308 Win.	22"	035201218	5	6 lbs. 5 oz.	41 3/4"	—	1 1/8"	1/2"	13 3/8"	1 in 12"	839.99
(SA) 270 WSM	23"	035201248	4	6 lbs. 8 oz.	42 3/4"	—	1 1/8"	1/2"	13 3/8"	1 in 10"	879.99
(SA) 7mm WSM	23"	035201249	4	6 lbs. 8 oz.	42 3/4"	—	1 1/8"	1/2"	13 3/8"	1 in 9 1/2"	879.99
(SA) 300 WSM	23"	035201246	4	6 lbs. 8 oz.	42 3/4"	—	1 1/8"	1/2"	13 3/8"	1 in 10"	879.99
(SA) 325 WSM	23"	035201277	4	6 lbs. 8 oz.	42 3/4"	—	1 1/8"	1/2"	13 3/8"	1 in 10"	879.99
(LA) 25-06 Rem.	24"	035201223	5	6 lbs. 11 oz.	44 3/4"	—	1 1/8"	1/2"	13 3/8"	1 in 10"	839.99
(LA) 270 Win.	22"	035201224	5	6 lbs. 9 oz.	42 3/4"	—	1 1/8"	1/2"	13 3/8"	1 in 10"	839.99
(LA) 280 Rem.	22"	035201225	5	6 lbs. 9 oz.	42 3/4"	—	1 1/8"	1/2"	13 3/8"	1 in 10"	839.99
(LA) 30-06 Sprg.	22"	035201226	5	6 lbs. 9 oz.	42 3/4"	—	1 1/8"	1/2"	13 3/8"	1 in 10"	839.99
(LA) 7mm Rem. Mag.	26"	035201227	4	6 lbs. 13 oz.	46 3/4"	—	1 1/8"	1/2"	13 3/8"	1 in 9 1/2"	879.99
(LA) 300 Win. Mag.	26"	035201229	4	6 lbs. 13 oz.	46 3/4"	—	1 1/8"	1/2"	13 3/8"	1 in 10"	879.99
(LA) 338 Win. Mag.	26"	035201231	4	6 lbs. 13 oz.	46 3/4"	—	1 1/8"	1/2"	13 3/8"	1 in 10"	879.99
X-BOLT STAINLESS STALKER											
(SSA) 223 Rem.	22"	035206208	6	6 lbs. 3 oz.	41 1/4"	—	1 1/8"	1/2"	13 3/8"	1 in 12"	\$1,119.99
(SSA) 22-250 Rem.	22"	035206209	5	6 lbs. 3 oz.	41 1/4"	—	1 1/8"	1/2"	13 3/8"	1 in 14"	1,119.99
(SA) 243 Win.	22"	035202211	5	6 lbs. 5 oz.	41 3/4"	—	1 1/8"	1/2"	13 3/8"	1 in 10"	1,119.99
(SA) 7mm-08 Rem.	22"	035202216	5	6 lbs. 5 oz.	41 3/4"	—	1 1/8"	1/2"	13 3/8"	1 in 9 1/2"	1,119.99
(SA) 308 Win.	22"	035202218	5	6 lbs. 5 oz.	41 3/4"	—	1 1/8"	1/2"	13 3/8"	1 in 12"	1,119.99
(SA) 270 WSM	23"	035202248	4	6 lbs. 8 oz.	42 3/4"	—	1 1/8"	1/2"	13 3/8"	1 in 10"	1,159.99
(SA) 7mm WSM	23"	035202249	4	6 lbs. 8 oz.	42 3/4"	—	1 1/8"	1/2"	13 3/8"	1 in 9 1/2"	1,159.99
(SA) 300 WSM	23"	035202246	4	6 lbs. 8 oz.	42 3/4"	—	1 1/8"	1/2"	13 3/8"	1 in 10"	1,159.99
(SA) 325 WSM	23"	035202277	4	6 lbs. 8 oz.	42 3/4"	—	1 1/8"	1/2"	13 3/8"	1 in 10"	1,159.99
(LA) 25-06 Rem.	24"	035202223	5	6 lbs. 11 oz.	44 3/4"	—	1 1/8"	1/2"	13 3/8"	1 in 10"	1,119.99
(LA) 270 Win.	22"	035202224	5	6 lbs. 9 oz.	42 3/4"	—	1 1/8"	1/2"	13 3/8"	1 in 10"	1,119.99
(LA) 280 Rem.	22"	035202225	5	6 lbs. 9 oz.	42 3/4"	—	1 1/8"	1/2"	13 3/8"	1 in 10"	1,119.99
(LA) 30-06 Sprg.	22"	035202226	5	6 lbs. 9 oz.	42 3/4"	—	1 1/8"	1/2"	13 3/8"	1 in 10"	1,119.99
(LA) 7mm Rem. Mag.	26"	035202227	4	6 lbs. 13 oz.	46 3/4"	—	1 1/8"	1/2"	13 3/8"	1 in 9 1/2"	1,159.99
(LA) 300 Win. Mag.	26"	035202229	4	6 lbs. 13 oz.	46 3/4"	—	1 1/8"	1/2"	13 3/8"	1 in 10"	1,159.99
(LA) 338 Win. Mag.	26"	035202231	4	6 lbs. 13 oz.	46 3/4"	—	1 1/8"	1/2"	13 3/8"	1 in 10"	1,159.99
(LA) 375 H&H Mag. (open sights)	24"	035202132	4	6 lbs. 13 oz.	44 3/4"	18"	1 1/8"	1/2"	13 3/8"	1 in 12"	1,159.99

NOTE: *Total capacity includes one round in the chamber. **Weights listed are approximate. ***Measured from centerline of bore.



X-BOLT VARMINT STALKER DURA-TOUCH® ARMOR COATING ON STOCK

RECEIVER Steel • Matte blued finish • Glass bedded • Drilled and tapped for scope mounts
BARREL Medium heavy • Matte blued finish • Free-floating • Hand chambered • Target crown
ACTION Bolt-action • 60° bolt lift • Adjustable Feather Trigger™ • Detachable rotary magazine
 • Top-tang safety • Bolt unlock button **STOCK** Composite • Textured gripping surfaces
 • Palm swell • Matte black • Dura-Touch® Armor Coating **FEATURES** Sling swivel studs installed
 • Inflex Technology recoil pad

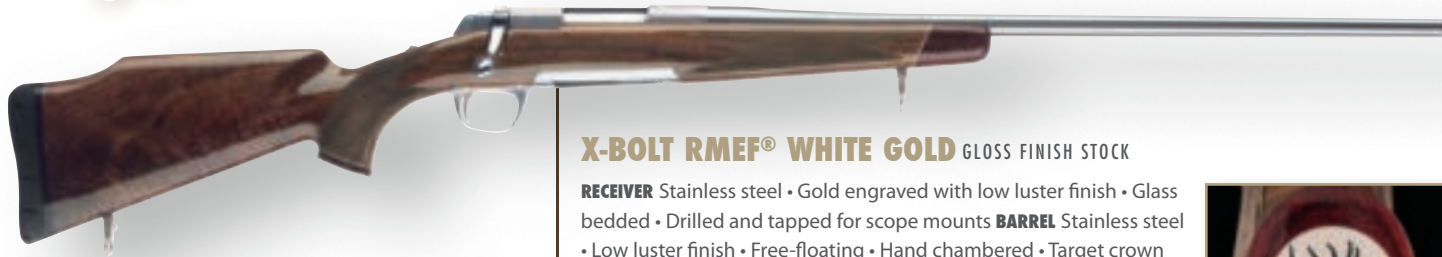

X-BOLT RMEF® WHITE GOLD GLOSS FINISH STOCK

RECEIVER Stainless steel • Gold engraved with low luster finish • Glass bedded • Drilled and tapped for scope mounts **BARREL** Stainless steel
 • Low luster finish • Free-floating • Hand chambered • Target crown
ACTION Bolt-action • 60° bolt lift • Adjustable Feather Trigger™
 • Detachable rotary magazine • Top-tang safety • Bolt unlock button
STOCK Select gloss finish walnut • Raised cheekpiece • Checkered
 • Rosewood grip and forearm caps • RMEF logo inset grip cap
FEATURES Sling swivel studs installed • Inflex Technology recoil pad
 • Sling swivels included



RMEF Logo Grip Cap



X-BOLT RMEF® SPECIAL HUNTER SATIN FINISH STOCK

RECEIVER Steel • Low-luster blued finish • Glass bedded • Drilled and tapped for scope mounts **BARREL** Matte blued finish • Free-floating
 • Hand chambered • Target crown **ACTION** Bolt-action • 60° bolt lift
 • Adjustable Feather Trigger™ • Detachable rotary magazine • Top-tang safety • Bolt unlock button **STOCK** Satin finish walnut • Raised cheekpiece • Checkered • Rosewood grip cap • RMEF logo inset grip cap
FEATURES Sling swivel studs installed • Inflex Technology recoil pad



(SSA) = Super-Short Action, (SA) = Short Action

CALIBER	BARREL LENGTH	CODE NUMBER	*TOTAL CAPACITY	**AVG. WEIGHT	OVERALL LENGTH	SIGHT RADIUS	***DROP AT COMB	DROP AT HEEL	LENGTH OF PULL	RATE OF TWIST	SUGG. RETAIL
X-BOLT VARMINT STALKER											
(SSA) 223 Rem.	24"	035207208	6	7 lbs. 15 oz.	43¼"	—	1½"	½"	13½"	1 in 12"	\$1,119.99
(SSA) 22-250 Rem.	26"	035207209	5	8 lbs. 2 oz.	45¼"	—	1½"	½"	13½"	1 in 14"	1,119.99
(SA) 243 Win.	24"	035203211	5	8 lbs. 1 oz.	43¼"	—	1½"	½"	13½"	1 in 10"	1,119.99
(SA) 308 Win.	24"	035203218	5	8 lbs. 1 oz.	43¼"	—	1½"	½"	13½"	1 in 12"	1,119.99
X-BOLT RMEF WHITE GOLD											
(SA) 325 WSM	23"	035217277	4	7 lbs. 3 oz.	42¾"	—	¾"	1½"	13½"	1 in 10"	\$1,499.99
X-BOLT RMEF SPECIAL HUNTER											
(SA) 325 WSM	23"	035218277	4	6 lbs. 14 oz.	42¾"	—	¾"	1½"	13½"	1 in 10"	\$1,099.99

NOTE: *Total capacity includes one round in the chamber. **Weights listed are approximate. ***Measured from centerline of bore.





DEPENDABILITY YOU CAN RELY ON.

Get your hands on one of the most reliable, best looking, from-the-box-accurate rifles ever, the Browning A-Bolt. These rifles have proven their value in chilly Texas whitetail stands, pursuing antelope in the high deserts of Wyoming and putting the crosshairs on massive bull elk high in the Colorado Rockies. The A-Bolt is also available with the BOSS® device that dials in barrel harmonics to precisely match the ammunition used for unequalled accuracy. Never doubt your rifle, choose a rugged Browning A-Bolt.

BOLT-ACTION

With a fast 60° lift that doesn't have you banging your hand on the scope, the bolt incorporates a non-rotating sleeve that runs the full length of the bolt. When unlocked, three guide ribs on the bolt sleeve align with the three locking lugs to allow the bolt to slide smoothly. When locked, the three lugs provide massive bolt strength. The A-Bolt feeds smoothly because of its unique, patented cartridge depressor. This cartridge depressor stays in position, independent of the bolt rotation, as the bolt slides gently over the cartridges in the magazine. The bolt face is recessed, completely surrounding the cartridge base.



MAGAZINE

Hinged floorplate with detachable box magazine makes it simple and fast to load a spare magazine.

MAGAZINE CAPACITY

Magnum calibers: Three in magazine, one in chamber.
Standard calibers: Four in magazine, one in chamber.
223 Rem.: Five in magazine, one in chamber.

A-BOLT HUNTER, FULL LINE DEALER SATIN FINISH STOCK

- RECEIVER** Steel • Low-luster blued finish • Glass bedded • Drilled and tapped for scope mounts
- BARREL** Low-luster blued finish • Free-floating
- Hand chambered • Target crown **ACTION** Bolt-action
- 60° bolt lift • Non-rotating bolt sleeve • Adjustable trigger
- Detachable box magazine • Hinged floorplate
- Top-tang safety **STOCK** Satin finish walnut • Raised cheekpiece • Checkered **FEATURES** Sling swivel studs installed • Recoil pad • Available only from Browning Full Line and Medallion Dealers



(SA) = Short Action

CALIBER	BARREL LENGTH	CODE NUMBER	*TOTAL CAPACITY	**AVG. WEIGHT	OVERALL LENGTH	SIGHT RADIUS	***DROP AT COMB	DROP AT HEEL	LENGTH OF PULL	RATE OF TWIST	SUGG. RETAIL
(SA) 270 WSM	23"	035017248	4	6 lbs. 9 oz.	42¾"	—	7/8"	1½"	13¾"	1 in 10"	\$1,029.99
(SA) 7mm WSM	23"	035017249	4	6 lbs. 9 oz.	42¾"	—	7/8"	1½"	13¾"	1 in 9½"	1,029.99
(SA) 300 WSM	23"	035017246	4	6 lbs. 9 oz.	42¾"	—	7/8"	1½"	13¾"	1 in 10"	1,029.99
(SA) 325 WSM	23"	035017277	4	6 lbs. 9 oz.	42¾"	—	7/8"	1½"	13¾"	1 in 10"	1,029.99

NOTE: *Total capacity includes one round in the chamber. **Weights listed are approximate. ***Measured from centerline of bore.



A-BOLT MICRO HUNTER SATIN FINISH STOCK

- RECEIVER** Steel • Low-luster blued finish • Glass bedded • Drilled and tapped for scope mounts **BARREL** Low-luster blued finish • Free-floating • Hand chambered • Target crown **ACTION** Bolt-action • 60° bolt lift • Non-rotating bolt sleeve • Adjustable trigger • Detachable box magazine • Hinged floorplate • Top-tang safety **STOCK** Satin finish walnut • Sized for smaller shooters • Checkered **FEATURES** Sling swivel studs installed • Recoil pad



PERSONALIZED ENGRAVING

The bolt of your A-Bolt rifle can be personalized with your name. Call (800) 333-3288.



A-BOLT MEDALLION GLOSS FINISH STOCK

- RECEIVER** Steel • Engraved with blued finish • Glass bedded • Drilled and tapped for scope mounts **BARREL** Blued finish • Free-floating • Hand chambered • Target crown **ACTION** Bolt-action • 60° bolt lift • Non-rotating bolt sleeve • Adjustable trigger • Detachable box magazine • Hinged floorplate • Top-tang safety **STOCK** Select gloss finish walnut • Rosewood fore-end and grip caps • Checkered **FEATURES** Sling swivels included • Recoil pad • BOSS® device optional



(SA) = Short Action, (LA) = Long Action

CALIBER	BARREL LENGTH	CODE NUMBER	*TOTAL CAPACITY	**AVG. WEIGHT	OVERALL LENGTH	SIGHT RADIUS	***DROP AT COMB	DROP AT HEEL	LENGTH OF PULL	RATE OF TWIST	SUGG. RETAIL
A-BOLT MICRO HUNTER											
(SA) 22 Hornet	22"	035020206	4	6 lbs. 6 oz.	41½"	—	⅝"	½"	13¾"	1 in 16"	\$869.99
A-BOLT MICRO HUNTER, LEFT-HAND (SHOWN)											
(SA) 22 Hornet	22"	035026206	4	6 lbs. 6 oz.	41½"	—	⅝"	½"	13¾"	1 in 16"	\$899.99
A-BOLT MEDALLION WITH BOSS											
(SA) 270 WSM	23"	035002348	4	6 lbs. 9 oz.	42¾"	—	⅝"	½"	13¾"	1 in 10"	\$1,149.99
(SA) 7mm WSM	23"	035002349	4	6 lbs. 9 oz.	42¾"	—	⅝"	½"	13¾"	1 in 9½"	1,149.99
(SA) 300 WSM	23"	035002346	4	6 lbs. 9 oz.	42¾"	—	⅝"	½"	13¾"	1 in 10"	1,149.99
(SA) 325 WSM	23"	035002377	4	6 lbs. 9 oz.	42¾"	—	⅝"	½"	13¾"	1 in 10"	1,149.99
(LA) 270 Win.	22"	035002324	5	6 lbs. 11 oz.	42½"	—	⅝"	½"	13¾"	1 in 10"	1,119.99
(LA) 30-06 Sprg.	22"	035002326	5	6 lbs. 11 oz.	42½"	—	⅝"	½"	13¾"	1 in 10"	1,119.99
(LA) 7mm Rem. Mag.	26"	035002327	4	7 lbs. 1 oz.	46½"	—	⅝"	½"	13¾"	1 in 9½"	1,149.99
(LA) 300 Win. Mag.	26"	035002329	4	7 lbs. 1 oz.	46½"	—	⅝"	½"	13¾"	1 in 10"	1,149.99
(LA) 338 Win. Mag.	26"	035002331	4	7 lbs. 1 oz.	46½"	—	⅝"	½"	13¾"	1 in 10"	1,149.99
(LA) 375 H&H Mag (open sights)	24"	035002332	4	7 lbs.	44½"	13"	⅝"	½"	13¾"	1 in 12"	1,149.99

NOTE: *Total capacity includes one round in the chamber. **Weights listed are approximate. ***Measured from centerline of bore.



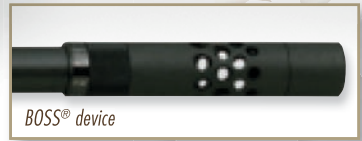

A-BOLT STAINLESS STALKER WITH BOSS® NON-GLARE COMPOSITE FINISH STOCK



RECEIVER Stainless steel • Matte finish • Glass bedded • Drilled and tapped for scope mounts **BARREL** Stainless steel • Matte finish • Free-floating • Hand chambered • Target crown **ACTION** Bolt-action • 60° bolt lift • Non-rotating bolt sleeve • Adjustable stainless steel trigger • Detachable box magazine • Hinged floorplate • Top-tang safety **STOCK** Composite • Palm swell • Matte black • Checkered **FEATURES** Sling swivel studs installed • Recoil pad • BOSS® device



A-BOLT COMPOSITE STALKER WITH BOSS® NON-GLARE COMPOSITE FINISH STOCK

RECEIVER Steel • Matte blued finish • Glass bedded • Drilled and tapped for scope mounts **BARREL** Matte blued finish • Free-floating • Hand chambered • Target crown **ACTION** Bolt-action • 60° bolt lift • Non-rotating bolt sleeve • Adjustable trigger • Detachable box magazine • Hinged floorplate • Top-tang safety **STOCK** Composite • Palm swell • Matte black • Checkered **FEATURES** Sling swivel studs installed • Recoil pad • BOSS® device

(SA) = Short Action, (LA) = Long Action

CALIBER	BARREL LENGTH	CODE NUMBER	*TOTAL CAPACITY	**AVG. WEIGHT	OVERALL LENGTH	SIGHT RADIUS	***DROP AT COMB	DROP AT HEEL	LENGTH OF PULL	RATE OF TWIST	SUGG. RETAIL
A-BOLT STAINLESS STALKER WITH BOSS (SHOWN)											
(SA) 270 WSM	23"	035008348	4	6 lbs. 6 oz.	42¾"	—	⅝"	½"	13¾"	1 in 10"	\$1,269.99
(SA) 7mm WSM	23"	035008349	4	6 lbs. 6 oz.	42¾"	—	⅝"	½"	13¾"	1 in 9½"	1,269.99
(SA) 300 WSM	23"	035008346	4	6 lbs. 6 oz.	42¾"	—	⅝"	½"	13¾"	1 in 10"	1,269.99
(SA) 325 WSM	23"	035008377	4	6 lbs. 6 oz.	42¾"	—	⅝"	½"	13¾"	1 in 10"	1,269.99
(LA) 270 Win.	22"	035008324	5	6 lbs. 11 oz.	42½"	—	⅝"	½"	13¾"	1 in 10"	1,239.99
(LA) 30-06 Sprg.	22"	035008326	5	6 lbs. 11 oz.	42½"	—	⅝"	½"	13¾"	1 in 10"	1,239.99
(LA) 7mm Rem. Mag.	26"	035008327	4	7 lbs. 3 oz.	46½"	—	⅝"	½"	13¾"	1 in 9½"	1,269.99
(LA) 300 Win. Mag.	26"	035008329	4	7 lbs. 3 oz.	46½"	—	⅝"	½"	13¾"	1 in 10"	1,269.99
(LA) 338 Win. Mag.	26"	035008331	4	7 lbs. 3 oz.	46½"	—	⅝"	½"	13¾"	1 in 10"	1,269.99
(LA) 375 H&H Mag. (open sights)	24"	035008332	4	7 lbs.	44½"	13"	⅝"	½"	13¾"	1 in 12"	1,269.99
A-BOLT STAINLESS STALKER WITH BOSS, LEFT-HAND											
(LA) 270 Win.	22"	035009324	5	6 lbs. 11 oz.	42¾"	—	⅝"	½"	13¾"	1 in 10"	\$1,269.99
(LA) 30-06 Sprg.	22"	035009326	5	6 lbs. 11 oz.	42¾"	—	⅝"	½"	13¾"	1 in 10"	1,269.99
(LA) 7mm Rem. Mag.	26"	035009327	4	7 lbs. 3 oz.	46¾"	—	⅝"	½"	13¾"	1 in 9½"	1,299.99
(LA) 300 Win. Mag.	26"	035009329	4	7 lbs. 3 oz.	46¾"	—	⅝"	½"	13¾"	1 in 10"	1,299.99
(LA) 338 Win. Mag.	26"	035009331	4	7 lbs. 3 oz.	46¾"	—	⅝"	½"	13¾"	1 in 10"	1,299.99
(LA) 375 H&H Mag. (open sights)	24"	035009332	4	7 lbs.	44¾"	13"	⅝"	½"	13¾"	1 in 12"	1,299.99
A-BOLT COMPOSITE STALKER WITH BOSS (SHOWN)											
(SA) 270 WSM	23"	035012348	4	6 lbs. 6 oz.	42¾"	—	⅝"	½"	13¾"	1 in 10"	\$1,029.99
(SA) 7mm WSM	23"	035012349	4	6 lbs. 6 oz.	42¾"	—	⅝"	½"	13¾"	1 in 9½"	1,029.99
(SA) 300 WSM	23"	035012346	4	6 lbs. 6 oz.	42¾"	—	⅝"	½"	13¾"	1 in 10"	1,029.99
(SA) 325 WSM	23"	035012377	4	6 lbs. 6 oz.	42¾"	—	⅝"	½"	13¾"	1 in 10"	1,029.99
(LA) 25-06 Rem.	24"	035012323	5	6 lbs. 14 oz.	44½"	—	⅝"	½"	13¾"	1 in 10"	999.99
(LA) 270 Win.	22"	035012324	5	6 lbs. 11 oz.	42½"	—	⅝"	½"	13¾"	1 in 10"	999.99
(LA) 30-06 Sprg.	22"	035012326	5	6 lbs. 11 oz.	42½"	—	⅝"	½"	13¾"	1 in 10"	999.99
(LA) 7mm Rem. Mag.	26"	035012327	4	7 lbs. 3 oz.	46½"	—	⅝"	½"	13¾"	1 in 9½"	1,029.99
(LA) 300 Win. Mag.	26"	035012329	4	7 lbs. 3 oz.	46½"	—	⅝"	½"	13¾"	1 in 10"	1,029.99
(LA) 338 Win. Mag.	26"	035012331	4	7 lbs. 3 oz.	46½"	—	⅝"	½"	13¾"	1 in 10"	1,029.99

NOTE: *Total capacity includes one round in the chamber. **Weights listed are approximate. ***Measured from centerline of bore.



A-BOLT TARGET SATIN FINISH LAMINATED STOCK

RECEIVER Steel • Matte blued finish • Glass bedded • Drilled and tapped for scope mounts **BARREL** Heavy bull contour • Matte blued finish • Free-floating • Hand chambered • Target crown **ACTION** Bolt-action • 60° bolt lift • Non-rotating bolt sleeve • Single-set trigger • Hinged floorplate • Top-tang safety **STOCK** Satin finish gray laminate • Target style with wide, flat fore-end • Adjustable comb • Right-hand palm swell • Checkered **FEATURES** Front sling swivel installed • Recoil pad (Scope and mounts not included)



A-BOLT TARGET STAINLESS SATIN FINISH LAMINATED STOCK

RECEIVER Stainless steel • Low luster finish • Glass bedded • Drilled and tapped for scope mounts **BARREL** Heavy bull contour • Stainless steel • Low luster finish • Free-floating • Hand chambered • Target crown **ACTION** Bolt-action • 60° bolt lift • Non-rotating bolt sleeve • Single-set trigger • Hinged floorplate • Top-tang safety **STOCK** Satin finish gray laminate • Target style with wide, flat fore-end • Adjustable comb • Right-hand palm swell • Checkered **FEATURES** Front sling swivel installed • Recoil pad (Scope and mounts not included)

(SA) = Short Action

CALIBER	BARREL LENGTH	CODE NUMBER	*TOTAL CAPACITY	**AVG. WEIGHT	OVERALL LENGTH	SIGHT RADIUS	***DROP AT COMB	DROP AT HEEL	LENGTH OF PULL	RATE OF TWIST	SUGG. RETAIL
A-BOLT TARGET											
(SA) 223 Rem.	28"	035189208	6	13 lbs. 4 oz.	47¾"	—	⅝" Adj.	⅝" Adj.	13¾"	1 in 8"	\$1,479.99
(SA) 308 Win.	28"	035189218	5	13 lbs.	47¾"	—	⅝" Adj.	⅝" Adj.	13¾"	1 in 10"	1,479.99
(SA) 300 WSM	28"	035189248	4	13 lbs.	47¾"	—	⅝" Adj.	⅝" Adj.	13¾"	1 in 10"	1,509.99
A-BOLT TARGET STAINLESS											
(SA) 223 Rem.	28"	035190208	6	13 lbs. 4 oz.	47¾"	—	⅝" Adj.	⅝" Adj.	13¾"	1 in 8"	\$1,739.99
(SA) 308 Win.	28"	035190218	5	13 lbs.	47¾"	—	⅝" Adj.	⅝" Adj.	13¾"	1 in 10"	1,739.99
(SA) 300 WSM	28"	035190248	4	13 lbs.	47¾"	—	⅝" Adj.	⅝" Adj.	13¾"	1 in 10"	1,779.99

NOTE: *Total capacity includes one round in the chamber. **Weights listed are approximate. ***Measured from centerline of bore.

A-BOLT TARGET RIFLES. TACK-DRIVING ACCURACY STRAIGHT FROM THE BOX.

Now you can experience jaw-dropping bolt-action rifle performance. Browning A-Bolt Target rifles feature a precise target-style, single-set trigger that is factory-adjusted to approximately 9-14 ounces (250-400 grams) of pull weight in the set mode, and also operates as a conventional trigger with an adjustment range of 4-6 lbs. Fitted with a 28" target barrel, the action is carefully bedded into a beautiful laminated stock with a wide fore-end for exceptional stability on sandbags or from a bench rest. A fully adjustable comb allows you to gain perfect eye-to-scope alignment, even with large objective target optics. Lastly, a close radius pistol grip ensures an easy reach to the trigger, so you can squeeze the most out of an A-Bolt Target rifle's accuracy.



THE BOSS® DEVICE

The Ballistic Optimizing Shooting System (BOSS) is designed to maximize accuracy from the A-Bolt. The BOSS device quickly and easily tunes barrel harmonics to precisely match the specific ammunition fired, resulting in amazingly tight groups. The BOSS device is available as an option on the Medallion, Composite Stalker, Stainless Stalker, M-1000 Eclipse and Stainless M-1000 Eclipse. An interchangeable, non-ported BOSS-CR is also included.

BOSS-CR ACCESSORY

This accessory is also included with all BOSS-equipped A-Bolt rifles and offers all the accuracy advantages of the original BOSS without the muzzle brake feature.

BEDDED ACTION AND FREE-FLOATED BARREL

The barrel is free-floating and the action is glass bedded at the recoil lug and at the front of the receiver to maintain the proper spacing around the barrel for consistent accuracy. Every A-Bolt features a recessed muzzle crown to protect the rifling. Barrels are hand chambered and triple checked for interior finish, straightness and air-gauged for uniformity.





A-BOLT ECLIPSE™ HUNTER WITH BOSS® SATIN FINISH LAMINATED STOCK

RECEIVER Steel • Matte blued finish • Glass bedded • Drilled and tapped for scope mounts **BARREL** Matte blued finish • Free-floating • Hand chambered • Target crown **ACTION** Bolt-action • 60° bolt lift • Non-rotating bolt sleeve • Adjustable trigger • Detachable box magazine • Hinged floorplate • Top-tang safety **STOCK** Laminated gray satin finish • Thumbhole grip • Monte Carlo cheekpiece • Checkered **FEATURES** Sling swivel studs installed • Recoil pad • BOSS® device



A-BOLT M-1000 ECLIPSE™ SATIN FINISH LAMINATED STOCK

RECEIVER Steel • Matte blued finish • Glass bedded • Drilled and tapped for scope mounts **BARREL** Heavy • Matte blued finish • Free-floating • Hand chambered • Target crown **ACTION** Bolt-action • 60° bolt lift • Non-rotating bolt sleeve • Adjustable trigger • Detachable box magazine • Hinged floorplate • Top-tang safety **STOCK** Laminated gray satin finish • Thumbhole grip • Monte Carlo cheekpiece • Checkered **FEATURES** Sling swivel studs installed • Recoil pad • BOSS® device optional



A-BOLT STAINLESS M-1000 ECLIPSE™ SATIN FINISH LAMINATED STOCK

RECEIVER Stainless steel • Low luster finish • Glass bedded • Drilled and tapped for scope mounts **BARREL** Heavy stainless steel • Low luster finish • Free-floating • Hand chambered • Target crown **ACTION** Bolt-action • 60° bolt lift • Non-rotating bolt sleeve • Adjustable stainless steel trigger • Detachable box magazine • Hinged floorplate • Top-tang safety **STOCK** Laminated gray satin finish • Thumbhole grip • Monte Carlo cheekpiece • Checkered **FEATURES** Sling swivel studs installed • Recoil pad • BOSS® device optional



(SA) = Short Action, (LA) = Long Action

CALIBER	BARREL LENGTH	CODE NUMBER	*TOTAL CAPACITY	**AVG. WEIGHT	OVERALL LENGTH	SIGHT RADIUS	***DROP AT COMB	DROP AT HEEL	LENGTH OF PULL	RATE OF TWIST	SUGG. RETAIL
A-BOLT ECLIPSE HUNTER WITH BOSS											
(LA) 270 Win.	22"	035005324	5	7 lbs. 8 oz.	42¾"	—	¾"	½"	13¾"	1 in 10"	\$1,429.99
(LA) 30-06 Sprg.	22"	035005326	5	7 lbs. 8 oz.	42¾"	—	¾"	½"	13¾"	1 in 10"	1,429.99
(LA) 7mm Rem. Mag.	26"	035005327	4	7 lbs. 12 oz.	46¾"	—	¾"	½"	13¾"	1 in 9½"	1,459.99
A-BOLT M-1000 ECLIPSE											
(SA) 22-250 Rem.	26"	035007209	5	9 lbs. 14 oz.	45¾"	—	¾"	½"	13¾"	1 in 14"	\$1,339.99
(SA) 308 Win.	26"	035007218	5	9 lbs. 14 oz.	45¾"	—	¾"	½"	13¾"	1 in 12"	1,339.99
(SA) 270 WSM	26"	035007248	4	9 lbs. 14 oz.	45¾"	—	¾"	½"	13¾"	1 in 10"	1,359.99
(SA) 7mm WSM	26"	035007249	4	9 lbs. 14 oz.	45¾"	—	¾"	½"	13¾"	1 in 9½"	1,359.99
(SA) 300 WSM	26"	035007246	4	9 lbs. 14 oz.	45¾"	—	¾"	½"	13¾"	1 in 10"	1,359.99
A-BOLT M-1000 ECLIPSE WITH BOSS (SHOWN)											
(SA) 22-250 Rem.	26"	035007309	5	10 lbs.	45¾"	—	¾"	½"	13¾"	1 in 14"	\$1,439.99
(SA) 308 Win.	26"	035007318	5	10 lbs.	45¾"	—	¾"	½"	13¾"	1 in 12"	1,439.99
(SA) 270 WSM	26"	035007348	4	10 lbs.	45¾"	—	¾"	½"	13¾"	1 in 10"	1,469.99
(SA) 7mm WSM	26"	035007349	4	10 lbs.	45¾"	—	¾"	½"	13¾"	1 in 9½"	1,469.99
(SA) 300 WSM	26"	035007346	4	10 lbs.	45¾"	—	¾"	½"	13¾"	1 in 10"	1,469.99
(LA) 300 Win. Mag.	26"	035007329	4	10 lbs.	46½"	—	¾"	½"	13¾"	1 in 10"	1,469.99
A-BOLT STAINLESS M-1000 ECLIPSE (SHOWN)											
(SA) 22-250 Rem.	26"	035032209	5	9 lbs. 14 oz.	45¾"	—	¾"	½"	13¾"	1 in 14"	\$1,599.99
(SA) 308 Win.	26"	035032218	5	9 lbs. 14 oz.	45¾"	—	¾"	½"	13¾"	1 in 12"	1,599.99
(SA) 270 WSM	26"	035032248	4	9 lbs. 14 oz.	45¾"	—	¾"	½"	13¾"	1 in 10"	1,639.99
(SA) 7mm WSM	26"	035032249	4	9 lbs. 14 oz.	45¾"	—	¾"	½"	13¾"	1 in 9½"	1,639.99
(SA) 300 WSM	26"	035032246	4	9 lbs. 14 oz.	45¾"	—	¾"	½"	13¾"	1 in 10"	1,639.99
A-BOLT STAINLESS M-1000 ECLIPSE WITH BOSS											
(SA) 22-250 Rem.	26"	035032309	5	10 lbs.	45¾"	—	¾"	½"	13¾"	1 in 14"	\$1,699.99
(SA) 308 Win.	26"	035032318	5	10 lbs.	45¾"	—	¾"	½"	13¾"	1 in 12"	1,699.99
(SA) 270 WSM	26"	035032348	4	10 lbs.	45¾"	—	¾"	½"	13¾"	1 in 10"	1,739.99
(SA) 7mm WSM	26"	035032349	4	10 lbs.	45¾"	—	¾"	½"	13¾"	1 in 9½"	1,739.99
(SA) 300 WSM	26"	035032346	4	10 lbs.	45¾"	—	¾"	½"	13¾"	1 in 10"	1,739.99

NOTE: *Total capacity includes one round in the chamber. **Weights listed are approximate. ***Measured from centerline of bore.



BOSS[®]-CR ACCESSORY



The BOSS-CR accessory offers all the accuracy and tunable advantages of the original BOSS device without the muzzle brake feature. By simply replacing the original BOSS forward weight and recoil reduction components with the one-piece, no-hole BOSS-CR accessory, only the reduced recoil of the original BOSS is sacrificed. The BOSS-CR accessory is designed to fit only BAR Mark II and A-Bolt centerfire rifles previously factory-fitted with the BOSS.

- | | | |
|--|---|--|
| GLOSS
BAR SAFARI
AND THE FOLLOWING
A-BOLT MODELS:
MEDALLION
GOLD MEDALLION | MATTE
A-BOLT MODELS:
COMPOSITE STALKER
HUNTER
EURO-BOLT
VARMINT
ECLIPSE HUNTER
M-1000 ECLIPSE | STAINLESS
A-BOLT MODELS:
STAINLESS STALKER
WHITE GOLD
MEDALLION
M-1000 ECLIPSE |
|--|---|--|

CALIBER	CODE NUMBER	CODE NUMBER	CODE NUMBER
223 Rem.	1140011	1140012	1140013
223 Varmint	1140061	1140062	—
223 WSSM	1140011	1140012	1140013
243 WSSM	1140011	1140012	1140013
25 WSSM	1140011	1140012	1140013
22-250 Rem.	1140011	1140012	1140013
22-250 Varmint	1140061	1140062	—
22-250 Varmint (M-1000)	—	1140062	1140063
243 Win.	1140011	1140012	1140013
7mm-08 Rem.	1140011	1140012	1140013
308 Win.	1140021	1140022	1140023
308 Varmint	1140061	1140062	—
308 Varmint (M-1000)	—	1140062	1140063
25-06 Rem.	1140011	1140012	1140013
260 Rem.	1140011	1140012	1140013
270 WSM	1140021	1140022	1140023
270 Win.	1140011	1140012	1140013
280 Rem.	1140011	1140012	1140013
30-06 Sprg.	1140031	1140032	1140033
7mm WSM	1140021	1140022	1140023
7mm Rem. Mag.	1140021	1140022	1140023
300 WSM	1140041	1140042	1140043
300 WSM (M-1000)	—	1140092	1140093
300 Win. Mag.	1140041	1140042	1140043
300 Win. Mag. (M-1000)	—	1140092	—
325 WSM	1140051	1140052	1140053
338 Win. Mag.	1140051	1140052	1140053
375 H&H Mag.	1140071	—	1140073

It is important that the correct BOSS-CR be selected for a specific caliber and model of rifle.

MODEL	SUGG. RETAIL
BOSS-CR, matte blue	\$39.99
BOSS-CR, gloss blue	39.99
BOSS-CR, stainless	39.99



A-BOLT[®] EXTRA MAGAZINES

CALIBER	CODE NUMBER	SUGG. RETAIL
ALL RIFLE MODELS EXCEPT MICRO HUNTER		
222 Rem.	112022007	\$79.99
204 Ruger	112022066	79.99
22-250 Rem.	112022009	79.99
223 Rem.	112022008	79.99
223 WSSM	112022044	79.99
223 Rem. SSA	112022060	79.99
243 Win.	112022011	79.99
243 WSSM	112022045	79.99
270 WSM	112022035	79.99
7mm-08 Rem.	112022016	79.99
7mm WSM	112022036	79.99
308 Win.	112022018	79.99
300 WSM	112022034	79.99
25 WSSM	112022049	79.99
25-06 Rem.	112022023	79.99
270 Win.	112022024	79.99
280 Rem.	112022025	79.99
30-06 Sprg.	112022026	79.99
7mm Rem. Mag.	112022027	79.99
300 Win. Mag.	112022029	79.99
300 Ultra Mag.	112022030	79.99
325 WSM	112022065	79.99
338 Win. Mag.	112022031	79.99
375 H&H Mag.	112022032	79.99
338 Ultra Mag.	112022038	79.99
MICRO HUNTER RIFLE		
22 Hornet	112023006	\$79.99
22-250 Rem.	112023009	79.99
243 Win.	112023011	79.99
270 WSM	112023041	79.99
7mm WSM	112023042	79.99
7mm-08 Rem.	112023016	79.99
308 Win.	112023018	79.99
300 WSM	112023040	79.99
325 WSM	11202304	79.99
A-BOLT SHOTGUN		
12 Gauge	112022001	\$79.99

NOTE: Magazines that are not listed above may be available only through the Browning Parts Department at (800) 322-4626.

NEVER LEAVE YOUR LEVER.

Most lever-action rifles suffer from accuracy problems caused by the limitations of the flat-nosed ammunition for which they are chambered. Not the Browning BLR. The BLR utilizes a reliable box magazine that protects bullet tips and allows it to fire powerful game-dropping magnum cartridges. An extremely smooth rack and pinion-driven bolt locks tight to the barrel and gives the BLR the kind of superior accuracy that rivals many bolt-actions.

**HAMMER**

The fold-down hammer has two positions at half-cock so the status of the rifle is readily seen. The folding hammer provides an added measure of safety when the hammer is at half-cock. The hammer has four basic positions: Full-cock, half-cock, folded hammer position and dropped, or fired position.

ACTION

Advanced, lightning fast, glass-smooth rack and pinion lever-action. Strong rotating head, multiple-lug breech bolt with a recessed bolt face and side ejection.

TRIGGER

Wide groove design trigger with crisp, smooth pull. The trigger travels with the lever to avoid pinching your fingers when cycling.

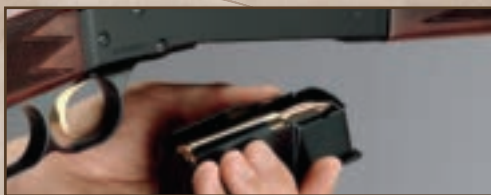
**MAGAZINE**

The flush-mounted detachable box magazine has a capacity of three magnum or four standard rounds, plus one in the chamber.

**TAKEDOWN FEATURES**

BLR Takedown models are just as accurate and reliable as their unified counterparts but much easier to transport and store. The rifle is easily and quickly assembled without tools by simply sliding the barrel half into the receiver half and locking them together with the flip of a lever. The lever mechanically engages a stout locking lug into a recess in the bottom of the receiver. The system is rugged, precise and blends seamlessly into the styling of the rifle.

SCOPE MOUNTS

A scout-style scope mount is available as an accessory for BLR Takedown models. This one-piece alloy base mounts forward of the receiver and stays attached to the barrel half of the rifle when disassembled to retain the scope's zero. A long eye-relief scope is required (not included). The receiver is also drilled and tapped for conventional scope bases and rings (not included). Three scout-style scope mounts are available for BLR Scout models, depending on the caliber (see chart on page 142).

**RECEIVER**

Lightweight, sturdy machined aircraft-grade aluminum. Drilled and tapped to accept scope mounts.

SIGHTS

Low profile, square notch, screw adjustable rear sight aligns easily with a highly visible gold bead on raised ramp front sight.



BLR LIGHTWEIGHT STAINLESS WITH PISTOL GRIP

GLOSS FINISH STOCK AND FOREARM

RECEIVER Aircraft-grade alloy • Satin nickel finish • Drilled and tapped for scope mounts
BARREL Matte stainless steel finish • Crowned muzzle • Adjustable sights **ACTION** Lever-action
 • Rotating bolt • Detachable box magazine **STOCK** Gloss finish walnut • Checkered pistol grip with Schnabel forearm **FEATURES** Sling swivel studs installed • Recoil pad



BLR LIGHTWEIGHT '81 STAINLESS TAKEDOWN

SATIN FINISH LAMINATED STOCK AND FOREARM

RECEIVER Aircraft-grade alloy • Satin nickel finish • Drilled and tapped for scope mounts
BARREL Matte stainless steel finish • Crowned muzzle • Adjustable sights • Drilled and tapped for scout mount **ACTION** Lever-action • Rotating bolt • Detachable box magazine **STOCK** Satin finish gray laminate wood • Checkered straight grip **FEATURES** Recoil pad • Separates for storage or transportation • Optional scout-style scope mount • TRUGLO®/Marble's® fiber-optic front sight



(SA) = Short Action, (LA) = Long Action

CALIBER	BARREL LENGTH	CODE NUMBER	*TOTAL CAPACITY	**AVG. WEIGHT	OVERALL LENGTH	SIGHT RADIUS	***DROP AT COMB	DROP AT HEEL	LENGTH OF PULL	RATE OF TWIST	SUGG. RETAIL
BLR LIGHTWEIGHT STAINLESS WITH PISTOL GRIP											
(SA) 223 Rem.	20"	034018108	5	6 lbs. 8 oz.	40"	17¾"	1"	1½"	13¾"	1 in 12"	\$1,099.99
(SA) 22-250 Rem.	20"	034018109	5	6 lbs. 8 oz.	40"	17¾"	1"	1½"	13¾"	1 in 14"	1,099.99
(SA) 243 Win.	20"	034018111	5	6 lbs. 8 oz.	40"	17¾"	1"	1½"	13¾"	1 in 10"	1,099.99
(SA) 7mm-08 Rem.	20"	034018116	5	6 lbs. 8 oz.	40"	17¾"	1"	1½"	13¾"	1 in 9½"	1,099.99
(SA) 308 Win.	20"	034018118	5	6 lbs. 8 oz.	40"	17¾"	1"	1½"	13¾"	1 in 12"	1,099.99
(SA) 358 Win.	20"	034018120	5	6 lbs. 8 oz.	40"	17¾"	1"	1½"	13¾"	1 in 12"	1,099.99
(SA) 450 Marlin	20"	034018150	4	7 lbs.	40"	17¾"	1"	1½"	13¾"	1 in 20"	1,099.99
(SA) 270 WSM	22"	034018148	4	6 lbs. 12 oz.	42"	19¾"	1"	1½"	13¾"	1 in 10"	1,179.99
(SA) 7mm WSM	22"	034018149	4	6 lbs. 12 oz.	42"	19¾"	1"	1½"	13¾"	1 in 9½"	1,179.99
(SA) 300 WSM	22"	034018146	4	6 lbs. 12 oz.	42"	19¾"	1"	1½"	13¾"	1 in 10"	1,179.99
(SA) 325 WSM	22"	034018177	4	6 lbs. 12 oz.	42"	19¾"	1"	1½"	13¾"	1 in 10"	1,179.99
(LA) 270 Win.	22"	034018124	5	7 lbs. 4 oz.	43"	19¾"	7/8"	1½"	14¼"	1 in 10"	1,149.99
(LA) 30-06 Sprg.	22"	034018126	5	7 lbs. 4 oz.	43"	19¾"	7/8"	1½"	14¼"	1 in 10"	1,149.99
(LA) 7mm Rem. Mag.	24"	034018127	4	7 lbs. 12 oz.	45"	20"	7/8"	1½"	14¼"	1 in 9½"	1,149.99
(LA) 300 Win. Mag.	24"	034018129	4	7 lbs. 12 oz.	45"	20"	7/8"	1½"	14¼"	1 in 10"	1,149.99
BLR LIGHTWEIGHT '81 STAINLESS TAKEDOWN											
(SA) 223 Rem.	20"	034015108	5	6 lbs. 8 oz.	40"	17¾"	1"	1½"	13¾"	1 in 12"	\$1,229.99
(SA) 22-250 Rem.	20"	034015109	5	6 lbs. 8 oz.	40"	17¾"	1"	1½"	13¾"	1 in 14"	1,229.99
(SA) 243 Win.	20"	034015111	5	6 lbs. 8 oz.	40"	17¾"	1"	1½"	13¾"	1 in 10"	1,229.99
(SA) 7mm-08 Rem.	20"	034015116	5	6 lbs. 8 oz.	40"	17¾"	1"	1½"	13¾"	1 in 9½"	1,229.99
(SA) 308 Win.	20"	034015118	5	6 lbs. 8 oz.	40"	17¾"	1"	1½"	13¾"	1 in 12"	1,229.99
(SA) 358 Win.	20"	034015120	5	6 lbs. 8 oz.	40"	17¾"	1"	1½"	13¾"	1 in 12"	1,229.99
(SA) 450 Marlin	20"	034015150	4	7 lbs.	40"	17¾"	1"	1½"	13¾"	1 in 20"	1,229.99
(SA) 270 WSM	22"	034015148	4	6 lbs. 12 oz.	42"	19¾"	1"	1½"	13¾"	1 in 10"	1,299.99
(SA) 7mm WSM	22"	034015149	4	6 lbs. 12 oz.	42"	19¾"	1"	1½"	13¾"	1 in 9½"	1,299.99
(SA) 300 WSM	22"	034015146	4	6 lbs. 12 oz.	42"	19¾"	1"	1½"	13¾"	1 in 10"	1,299.99
(SA) 325 WSM	22"	034015177	4	6 lbs. 12 oz.	42"	19¾"	1"	1½"	13¾"	1 in 10"	1,299.99
(LA) 270 Win.	22"	034015124	5	7 lbs. 4 oz.	43"	19¾"	7/8"	1½"	14¼"	1 in 10"	1,279.99
(LA) 30-06 Sprg.	22"	034015126	5	7 lbs. 4 oz.	43"	19¾"	7/8"	1½"	14¼"	1 in 10"	1,279.99
(LA) 7mm Rem. Mag.	24"	034015127	4	7 lbs. 12 oz.	45"	20"	7/8"	1½"	14¼"	1 in 9½"	1,279.99
(LA) 300 Win. Mag.	24"	034015129	4	7 lbs. 12 oz.	45"	20"	7/8"	1½"	14¼"	1 in 10"	1,279.99

NOTE: *Total capacity includes one round in the chamber. **Weights listed are approximate. ***Measured from centerline of bore.





BLR LIGHTWEIGHT TAKEDOWN WITH PISTOL GRIP

GLOSS FINISH STOCK AND FOREARM

- RECEIVER** Aircraft-grade alloy • Blued finish • Drilled and tapped for scope mounts
- BARREL** Blued finish • Crowned muzzle • Adjustable sights • Drilled and tapped for scout mount
- ACTION** Lever-action • Rotating bolt • Detachable box magazine **STOCK** Gloss finish walnut
- Checkered pistol grip with Schnabel forearm **FEATURES** Sling swivel studs installed • Recoil pad
- Separates for storage or transportation • Optional scout-style scope mount



BLR LIGHTWEIGHT TAKEDOWN SCOUT-STYLE SCOPE MOUNT

DESCRIPTION	CODE #	SUGG. RETAIL
Short Action Mount	12327	\$69.99
WSM/Long Action/Magnum Mount	12326	69.99
450 Marlin Mount	12325	69.99

- FEATURES** Aircraft-grade alloy
- Blued finish • One-piece design
- Easy installation



Scout-Style Scope Mount



BLR LIGHTWEIGHT WITH PISTOL GRIP

GLOSS FINISH STOCK AND FOREARM

- RECEIVER** Aircraft-grade alloy • Blued finish • Drilled and tapped for scope mounts
- BARREL** Blued finish • Crowned muzzle • Adjustable sights **ACTION** Lever-action • Rotating bolt
- Detachable box magazine **STOCK** Gloss finish walnut • Checkered pistol grip with Schnabel forearm **FEATURES** Sling swivel studs installed • Recoil pad



(SA) = Short Action, (LA) = Long Action

CALIBER	BARREL LENGTH	CODE NUMBER	*TOTAL CAPACITY	**AVG. WEIGHT	OVERALL LENGTH	SIGHT RADIUS	***DROP AT COMB	DROP AT HEEL	LENGTH OF PULL	RATE OF TWIST	SUGG. RETAIL
BLR LIGHTWEIGHT TAKEDOWN WITH PISTOL GRIP											
(SA) 223 Rem.	20"	034012108	5	6 lbs. 8 oz.	40"	17¾"	¾"	15/16"	13¾"	1 in 12"	\$1,099.99
(SA) 22-250 Rem.	20"	034012109	5	6 lbs. 8 oz.	40"	17¾"	¾"	15/16"	13¾"	1 in 14"	1,099.99
(SA) 243 Win.	20"	034012111	5	6 lbs. 8 oz.	40"	17¾"	¾"	15/16"	13¾"	1 in 10"	1,099.99
(SA) 7mm-08 Rem.	20"	034012116	5	6 lbs. 8 oz.	40"	17¾"	¾"	15/16"	13¾"	1 in 9½"	1,099.99
(SA) 308 Win.	20"	034012118	5	6 lbs. 8 oz.	40"	17¾"	¾"	15/16"	13¾"	1 in 12"	1,099.99
(SA) 358 Win.	20"	034012120	5	6 lbs. 8 oz.	40"	17¾"	¾"	15/16"	13¾"	1 in 12"	1,099.99
(SA) 450 Marlin	20"	034012150	4	7 lbs.	40"	17¾"	¾"	15/16"	13¾"	1 in 20"	1,099.99
(SA) 270 WSM	22"	034012148	4	6 lbs. 12 oz.	42"	19¾"	¾"	15/16"	13¾"	1 in 10"	1,179.99
(SA) 7mm WSM	22"	034012149	4	6 lbs. 12 oz.	42"	19¾"	¾"	15/16"	13¾"	1 in 9½"	1,179.99
(SA) 300 WSM	22"	034012146	4	6 lbs. 12 oz.	42"	19¾"	¾"	15/16"	13¾"	1 in 10"	1,179.99
(SA) 325 WSM	22"	034012177	4	6 lbs. 12 oz.	42"	19¾"	¾"	15/16"	13¾"	1 in 10"	1,179.99
(LA) 270 Win.	22"	034012124	5	7 lbs. 4 oz.	43"	19¾"	1"	1"	14¼"	1 in 10"	1,149.99
(LA) 30-06 Sprg.	22"	034012126	5	7 lbs. 4 oz.	43"	19¾"	1"	1"	14¼"	1 in 10"	1,149.99
(LA) 7mm Rem. Mag.	24"	034012127	4	7 lbs. 12 oz.	45"	20"	1"	1"	14¼"	1 in 9½"	1,149.99
(LA) 300 Win. Mag.	24"	034012129	4	7 lbs. 12 oz.	45"	20"	1"	1"	14¼"	1 in 10"	1,149.99
BLR LIGHTWEIGHT WITH PISTOL GRIP											
(SA) 223 Rem.	20"	034009108	5	6 lbs. 8 oz.	40"	17¾"	¾"	15/16"	13¾"	1 in 12"	\$1,019.99
(SA) 22-250 Rem.	20"	034009109	5	6 lbs. 8 oz.	40"	17¾"	¾"	15/16"	13¾"	1 in 14"	1,019.99
(SA) 243 Win.	20"	034009111	5	6 lbs. 8 oz.	40"	17¾"	¾"	15/16"	13¾"	1 in 10"	1,019.99
(SA) 7mm-08 Rem.	20"	034009116	5	6 lbs. 8 oz.	40"	17¾"	¾"	15/16"	13¾"	1 in 9½"	1,019.99
(SA) 308 Win.	20"	034009118	5	6 lbs. 8 oz.	40"	17¾"	¾"	15/16"	13¾"	1 in 12"	1,019.99
(SA) 358 Win.	20"	034009120	5	6 lbs. 8 oz.	40"	17¾"	¾"	15/16"	13¾"	1 in 12"	1,019.99
(SA) 450 Marlin	20"	034009150	4	7 lbs.	40"	17¾"	¾"	15/16"	13¾"	1 in 20"	1,019.99
(SA) 270 WSM	22"	034009148	4	6 lbs. 12 oz.	42"	19¾"	¾"	15/16"	13¾"	1 in 10"	1,099.99
(SA) 7mm WSM	22"	034009149	4	6 lbs. 12 oz.	42"	19¾"	¾"	15/16"	13¾"	1 in 9½"	1,099.99
(SA) 300 WSM	22"	034009146	4	6 lbs. 12 oz.	42"	19¾"	¾"	15/16"	13¾"	1 in 10"	1,099.99
(SA) 325 WSM	22"	034009177	4	6 lbs. 12 oz.	42"	19¾"	¾"	15/16"	13¾"	1 in 10"	1,099.99
(LA) 270 Win.	22"	034009124	5	7 lbs. 4 oz.	43"	19¾"	1"	1"	14¼"	1 in 10"	1,069.99
(LA) 30-06 Sprg.	22"	034009126	5	7 lbs. 4 oz.	43"	19¾"	1"	1"	14¼"	1 in 10"	1,069.99
(LA) 7mm Rem. Mag.	24"	034009127	4	7 lbs. 12 oz.	45"	20"	1"	1"	14¼"	1 in 9½"	1,069.99
(LA) 300 Win. Mag.	24"	034009129	4	7 lbs. 12 oz.	45"	20"	1"	1"	14¼"	1 in 10"	1,069.99

NOTE: *Total capacity includes one round in the chamber. **Weights listed are approximate. ***Measured from centerline of bore.



BLR LIGHTWEIGHT '81 TAKEDOWN GLOSS FINISH STOCK AND FOREARM

RECEIVER Aircraft-grade alloy • Blued finish • Drilled and tapped for scope mounts
BARREL Blued finish • Crowned muzzle • Adjustable sights • Drilled and tapped for scout mount
ACTION Lever-action • Rotating bolt • Detachable box magazine **STOCK** Gloss finish walnut • Checkered • Straight grip **FEATURES** Recoil pad • Separates for storage or transportation • Optional scout-style scope mount (Scope and mounts not included)



BLR LIGHTWEIGHT '81 GLOSS FINISH STOCK AND FOREARM

RECEIVER Aircraft-grade alloy • Blued finish • Drilled and tapped for scope mounts
BARREL Blued finish • Crowned muzzle • Adjustable sights **ACTION** Lever-action • Rotating bolt • Detachable box magazine **STOCK** Gloss finish walnut • Checkered • Straight grip **FEATURES** Recoil pad

(SA) = Short Action, (LA) = Long Action

CALIBER	BARREL LENGTH	CODE NUMBER	*TOTAL CAPACITY	**AVG. WEIGHT	OVERALL LENGTH	SIGHT RADIUS	***DROP AT COMB	DROP AT HEEL	LENGTH OF PULL	RATE OF TWIST	SUGG. RETAIL
BLR LIGHTWEIGHT '81 TAKEDOWN											
(SA) 223 Rem.	20"	034011108	5	6 lbs. 8 oz.	40"	17¼"	7/8"	15/16"	13¾"	1 in 12"	\$1,039.99
(SA) 22-250 Rem.	20"	034011109	5	6 lbs. 8 oz.	40"	17¾"	7/8"	15/16"	13¾"	1 in 14"	1,039.99
(SA) 243 Win.	20"	034011111	5	6 lbs. 8 oz.	40"	17¼"	7/8"	15/16"	13¾"	1 in 10"	1,039.99
(SA) 7mm-08 Rem.	20"	034011116	5	6 lbs. 8 oz.	40"	17¾"	7/8"	15/16"	13¾"	1 in 9½"	1,039.99
(SA) 308 Win.	20"	034011118	5	6 lbs. 8 oz.	40"	17¾"	7/8"	15/16"	13¾"	1 in 12"	1,039.99
(SA) 358 Win.	20"	034011120	5	6 lbs. 8 oz.	40"	17¾"	7/8"	15/16"	13¾"	1 in 12"	1,039.99
(SA) 450 Marlin	20"	034011150	4	7 lbs.	40"	17¾"	7/8"	15/16"	13¾"	1 in 20"	1,039.99
(SA) 270 WSM	22"	034011148	4	6 lbs. 12 oz.	42"	19¾"	7/8"	15/16"	13¾"	1 in 10"	1,119.99
(SA) 7mm WSM	22"	034011149	4	6 lbs. 12 oz.	42"	19¾"	7/8"	15/16"	13¾"	1 in 9½"	1,119.99
(SA) 300 WSM	22"	034011146	4	6 lbs. 12 oz.	42"	19¾"	7/8"	15/16"	13¾"	1 in 10"	1,119.99
(SA) 325 WSM	22"	034011177	4	6 lbs. 12 oz.	42"	19¾"	7/8"	15/16"	13¾"	1 in 10"	1,119.99
(LA) 270 Win.	22"	034011124	5	7 lbs. 4 oz.	43"	19¾"	1"	1 1/8"	14¼"	1 in 10"	1,099.99
(LA) 30-06 Sprg.	22"	034011126	5	7 lbs. 4 oz.	43"	19¾"	1"	1 1/8"	14¼"	1 in 10"	1,099.99
(LA) 7mm Rem. Mag.	24"	034011127	4	7 lbs. 12 oz.	45"	20"	1"	1 1/8"	14¼"	1 in 9½"	1,099.99
(LA) 300 Win. Mag.	24"	034011129	4	7 lbs. 12 oz.	45"	20"	1"	1 1/8"	14¼"	1 in 10"	1,099.99
BLR LIGHTWEIGHT '81											
(SA) 223 Rem.	20"	034006108	5	6 lbs. 8 oz.	40"	17¼"	7/8"	15/16"	13¾"	1 in 12"	\$959.99
(SA) 22-250 Rem.	20"	034006109	5	6 lbs. 8 oz.	40"	17¾"	7/8"	15/16"	13¾"	1 in 14"	959.99
(SA) 243 Win.	20"	034006111	5	6 lbs. 8 oz.	40"	17¼"	7/8"	15/16"	13¾"	1 in 10"	959.99
(SA) 7mm-08 Rem.	20"	034006116	5	6 lbs. 8 oz.	40"	17¾"	7/8"	15/16"	13¾"	1 in 9½"	959.99
(SA) 308 Win.	20"	034006118	5	6 lbs. 8 oz.	40"	17¾"	7/8"	15/16"	13¾"	1 in 12"	959.99
(SA) 358 Win.	20"	034006120	5	6 lbs. 8 oz.	40"	17¾"	7/8"	15/16"	13¾"	1 in 12"	959.99
(SA) 450 Marlin	20"	034006150	4	7 lbs.	40"	17¾"	7/8"	15/16"	13¾"	1 in 20"	959.99
(SA) 270 WSM	22"	034006148	4	6 lbs. 12 oz.	42"	19¾"	7/8"	15/16"	13¾"	1 in 10"	1,039.99
(SA) 7mm WSM	22"	034006149	4	6 lbs. 12 oz.	42"	19¾"	7/8"	15/16"	13¾"	1 in 9½"	1,039.99
(SA) 300 WSM	22"	034006146	4	6 lbs. 12 oz.	42"	19¾"	7/8"	15/16"	13¾"	1 in 10"	1,039.99
(SA) 325 WSM	22"	034006177	4	6 lbs. 12 oz.	42"	19¾"	7/8"	15/16"	13¾"	1 in 10"	1,039.99
(LA) 270 Win.	22"	034006124	5	7 lbs. 4 oz.	43"	19¾"	1"	1 1/8"	14¼"	1 in 10"	1,019.99
(LA) 30-06 Sprg.	22"	034006126	5	7 lbs. 4 oz.	43"	19¾"	1"	1 1/8"	14¼"	1 in 10"	1,019.99
(LA) 7mm Rem. Mag.	24"	034006127	4	7 lbs. 12 oz.	45"	20"	1"	1 1/8"	14¼"	1 in 9½"	1,019.99
(LA) 300 Win. Mag.	24"	034006129	4	7 lbs. 12 oz.	45"	20"	1"	1 1/8"	14¼"	1 in 10"	1,019.99

NOTE: *Total capacity includes one round in the chamber. **Weights listed are approximate. ***Measured from centerline of bore.

BLR EXTRA MAGAZINES

CALIBER	CODE NUMBER	SUGG. RETAIL	CALIBER	CODE NUMBER	SUGG. RETAIL
SHORT ACTION CALIBERS			LONG AND SHORT ACTION CALIBERS		
223 Rem.	112026008	\$79.99	270 Win.	112026024	\$79.99
243 Win.	112026011	79.99	30-06 Sprg.	112026026	79.99
308 Win.	112026012	79.99	7mm Rem. Mag.	112026027	79.99
22-250 Rem.	112026009	79.99	300 Win. Mag.	112026029	79.99
7mm-08 Rem.	112026016	79.99	325 WSM	112022067	79.99
270 WSM	112026030	79.99	358 Win.	112026042	79.99
300 WSM	112026041	79.99	450 Marlin	112026043	79.99
7mm WSM	112026031	79.99			



HARD-HITTING AUTOLOADER ACCURACY.

There is still only one Browning BAR. These legendary autoloaders combine pinpoint accuracy with the raw strength to fire magnum cartridges. The dependable BAR features a multi-lug rotary bolt that secures the bolt to the barrel for unmatched strength. The piston-operated gas system is reliable and softens felt recoil to reduce muzzle climb.



THE BOSS® DEVICE

The Ballistic Optimizing Shooting System (BOSS) is designed to maximize accuracy from the BAR. The BOSS device quickly and easily tunes barrel harmonics to precisely match the specific ammunition being fired to deliver amazingly tight groups. The BOSS device is available as an option on the BAR MK II Safari.

BOSS-CR DEVICE

The BOSS-CR device offers all the accuracy advantages of the original BOSS device without the muzzle brake feature.



MAGAZINE

Detachable box magazine with a unique hinged floorplate allows you to lower the floorplate, detach the empty magazine and snap in a full magazine in mere seconds.



ADJUSTABLE SHIM SYSTEM

ShortTrac® and LongTrac® BAR rifles include six shims that let you customize the drop at comb and cast on/off of the rifle to your ideal dimensions.

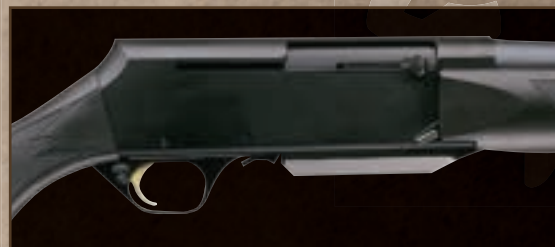

RECEIVER

The Safari model uses a richly blued one-piece ordnance steel receiver with scroll engraving. Stalker, ShortTrac® and LongTrac® models have an aircraft-grade aluminum alloy receiver. All BAR rifles are drilled and tapped for scope mounts. The bolt release lever is incorporated into the receiver.



ACTION

The BAR is a gas-operated autoloader with a high-strength, multiple-lug rotating bolt that locks directly into the barrel. Every cartridge loaded into the chamber of the BAR is surrounded by a recessed bolt face, which is encircled by the barrel and then surrounded by the receiver. A seven-lug bolt and precise breech-to-chamber relationship give the BAR exceptional accuracy and the strength to handle magnum loads. The strong and very rigid action bar/inertia block link-up improves accuracy by reducing barrel vibration. The buffering system reduces wear and stress on the rifle's mechanism.



MAXIMUM GRIP

Camo composite BAR models combine checkered or overmolded gripping surfaces and Browning's proven Dura-Touch® Armor Coating for a sure hold and a sleek feel in all climate conditions.

BAR LongTrac, Left-Hand



BAR LongTrac, Right-Hand

LONG TRAC

BAR LONGTRAC® OIL FINISH STOCK AND FOREARM

RECEIVER Aircraft-grade alloy • Satin nickel finish • High-relief engraving • Drilled and tapped for scope mounts **BARREL** Blued finish • Hammer-forged **ACTION** Gas-operated autoloader • Multi-lug rotary bolt • Detachable box magazine • Composite trigger guard and floorplate • Crossbolt safety **STOCK** Oil finish Grade II walnut • Stylized forearm • Checkered • Shim adjustable for cast on/off and drop at comb **FEATURES** Sling swivel studs installed • Interchangeable recoil pad (See page 76 for additional pads)

BAR ShortTrac, Left-Hand



BAR ShortTrac, Right-Hand

SHORT TRAC



BAR SHORTTRAC® OIL FINISH STOCK AND FOREARM

RECEIVER Aircraft-grade alloy • Satin nickel finish • High-relief engraving • Drilled and tapped for scope mounts **BARREL** Blued finish • Hammer-forged **ACTION** Gas-operated autoloader • Multi-lug rotary bolt • Detachable box magazine • Composite trigger guard and floorplate • Crossbolt safety **STOCK** Oil finish Grade II walnut • Stylized forearm • Checkered • Shim adjustable for cast on/off and drop at comb **FEATURES** Sling swivel studs installed • Interchangeable recoil pad (See page 76 for additional pads)

(SA) = Short Action, (LA) = Long Action

	CALIBER	BARREL LENGTH	CODE NUMBER	*TOTAL CAPACITY	**AVG. WEIGHT	OVERALL LENGTH	SIGHT RADIUS	***DROP AT COMB	DROP AT HEEL	LENGTH OF PULL	RATE OF TWIST	SUGG. RETAIL
BAR LONGTRAC, LEFT-HAND												
(LA)	270 Win.	22"	031537224	5	6 lbs. 15 oz.	43"	—	5/8"	1 1/8"	13 3/8"	1 in 10"	\$1,269.99
(LA)	30-06 Sprg.	22"	031537226	5	6 lbs. 15 oz.	43"	—	5/8"	1 1/8"	13 3/8"	1 in 10"	1,269.99
(LA)	7mm Rem. Mag.	24"	031537227	4	7 lbs. 8 oz.	45"	—	5/8"	1 1/8"	13 3/8"	1 in 9 1/2"	1,349.99
(LA)	300 Win. Mag.	24"	031537229	4	7 lbs. 8 oz.	45"	—	5/8"	1 1/8"	13 3/8"	1 in 10"	1,349.99
BAR LONGTRAC, RIGHT-HAND												
(LA)	270 Win.	22"	031536224	5	6 lbs. 15 oz.	43"	—	5/8"	1 1/8"	13 3/8"	1 in 10"	\$1,229.99
(LA)	30-06 Sprg.	22"	031536226	5	6 lbs. 15 oz.	43"	—	5/8"	1 1/8"	13 3/8"	1 in 10"	1,229.99
(LA)	7mm Rem. Mag.	24"	031536227	4	7 lbs. 8 oz.	45"	—	5/8"	1 1/8"	13 3/8"	1 in 9 1/2"	1,319.99
(LA)	300 Win. Mag.	24"	031536229	4	7 lbs. 8 oz.	45"	—	5/8"	1 1/8"	13 3/8"	1 in 10"	1,319.99
BAR SHORTTRAC, LEFT-HAND												
(SA)	243 Win.	22"	031535211	5	6 lbs. 10 oz.	42 3/4"	—	5/8"	1 1/8"	13 1/4"	1 in 10"	\$1,269.99
(SA)	7mm-08 Rem.	22"	031535216	5	6 lbs. 10 oz.	42 3/4"	—	5/8"	1 1/8"	13 1/4"	1 in 9 1/2"	1,269.99
(SA)	308 Win.	22"	031535218	5	6 lbs. 10 oz.	42 3/4"	—	5/8"	1 1/8"	13 1/4"	1 in 12"	1,269.99
(SA)	270 WSM	23"	031535248	4	7 lbs. 4 oz.	43 3/4"	—	5/8"	1 1/8"	13 1/4"	1 in 10"	1,359.99
(SA)	7mm WSM	23"	031535249	4	7 lbs. 4 oz.	43 3/4"	—	5/8"	1 1/8"	13 1/4"	1 in 9 1/2"	1,359.99
(SA)	300 WSM	23"	031535246	4	7 lbs. 4 oz.	43 3/4"	—	5/8"	1 1/8"	13 1/4"	1 in 10"	1,359.99
(SA)	325 WSM	23"	031535277	4	7 lbs. 4 oz.	43 3/4"	—	5/8"	1 1/8"	13 1/4"	1 in 10"	1,359.99
BAR SHORTTRAC, RIGHT-HAND												
(SA)	243 Win.	22"	031534211	5	6 lbs. 10 oz.	42 3/4"	—	5/8"	1 1/8"	13 1/4"	1 in 10"	\$1,229.99
(SA)	7mm-08 Rem.	22"	031534216	5	6 lbs. 10 oz.	42 3/4"	—	5/8"	1 1/8"	13 1/4"	1 in 9 1/2"	1,229.99
(SA)	308 Win.	22"	031534218	5	6 lbs. 10 oz.	42 3/4"	—	5/8"	1 1/8"	13 1/4"	1 in 12"	1,229.99
(SA)	270 WSM	23"	031534248	4	7 lbs. 4 oz.	43 3/4"	—	5/8"	1 1/8"	13 1/4"	1 in 10"	1,339.99
(SA)	7mm WSM	23"	031534249	4	7 lbs. 4 oz.	43 3/4"	—	5/8"	1 1/8"	13 1/4"	1 in 9 1/2"	1,339.99
(SA)	300 WSM	23"	031534246	4	7 lbs. 4 oz.	43 3/4"	—	5/8"	1 1/8"	13 1/4"	1 in 10"	1,339.99
(SA)	325 WSM	23"	031534277	4	7 lbs. 4 oz.	43 3/4"	—	5/8"	1 1/8"	13 1/4"	1 in 10"	1,339.99

NOTE: *Total capacity includes one round in the chamber. **Weights listed are approximate. ***Measured from centerline of bore.





SHORT TRAC



DURA-TOUCH®
Armor Coating



BAR SHORTRAC®, MOSSY OAK® BREAK-UP INFINITY®

DURA-TOUCH® ARMOR COATING ON STOCK AND FOREARM

RECEIVER Aircraft-grade alloy • Drilled and tapped for scope mounts **BARREL** Hammer-forged **ACTION** Gas-operated autoloader • Multi-lug rotary bolt • Detachable box magazine • Composite trigger guard and floorplate • Crossbolt safety **STOCK** Composite • Dura-Touch® Armor Coating • Mossy Oak® Break-Up Infinity® camo finish • Gripping panels • Shim adjustable for cast on/off and drop at comb **FEATURES** Sling swivel studs installed • Interchangeable recoil pad (See page 76 for additional pads)



BAR LONGTRAC®, MOSSY OAK® BREAK-UP INFINITY®

DURA-TOUCH® ARMOR COATING ON STOCK AND FOREARM

RECEIVER Aircraft-grade alloy • Drilled and tapped for scope mounts **BARREL** Hammer-forged **ACTION** Gas-operated autoloader • Multi-lug rotary bolt • Detachable box magazine • Composite trigger guard and floorplate • Crossbolt safety **STOCK** Composite • Dura-Touch® Armor Coating • Mossy Oak® Break-Up Infinity® camo finish • Gripping panels • Shim adjustable for cast on/off and drop at comb **FEATURES** Sling swivel studs installed • Interchangeable recoil pad (See page 76 for additional pads)



DURA-TOUCH®
Armor Coating

LONG TRAC



(SA) = Short Action, (LA) = Long Action

	CALIBER	BARREL LENGTH	CODE NUMBER	*TOTAL CAPACITY	**AVG. WEIGHT	OVERALL LENGTH	SIGHT RADIUS	***DROP AT COMB	DROP AT HEEL	LENGTH OF PULL	RATE OF TWIST	SUGG. RETAIL
BAR SHORTRAC, MOSSY OAK BREAK-UP INFINITY												
(SA)	243 Win.	22"	031022211	5	6 lbs. 10 oz.	41½"	—	¾"	1½"	13¾"	1 in 10"	\$1,359.99
(SA)	7mm-08 Rem.	22"	031022216	5	6 lbs. 10 oz.	41½"	—	¾"	1½"	13¾"	1 in 9½"	1,359.99
(SA)	308 Win.	22"	031022218	5	6 lbs. 10 oz.	41½"	—	¾"	1½"	13¾"	1 in 12"	1,359.99
(SA)	270 WSM	23"	031022248	4	7 lbs. 4 oz.	42½"	—	¾"	1½"	13¾"	1 in 10"	1,479.99
(SA)	7mm WSM	23"	031022249	4	7 lbs. 4 oz.	42½"	—	¾"	1½"	13¾"	1 in 9½"	1,479.99
(SA)	300 WSM	23"	031022246	4	7 lbs. 4 oz.	42½"	—	¾"	1½"	13¾"	1 in 10"	1,479.99
(SA)	325 WSM	23"	031022277	4	7 lbs. 4 oz.	42½"	—	¾"	1½"	13¾"	1 in 10"	1,479.99
BAR LONGTRAC, MOSSY OAK BREAK-UP INFINITY												
(LA)	270 Win.	22"	031023224	5	6 lbs. 15 oz.	42"	—	¾"	1½"	13¾"	1 in 10"	\$1,359.99
(LA)	30-06 Sprg.	22"	031023226	5	6 lbs. 15 oz.	42"	—	¾"	1½"	13¾"	1 in 10"	1,359.99
(LA)	7mm Rem. Mag.	24"	031023227	4	7 lbs. 8 oz.	44"	—	¾"	1½"	13¾"	1 in 9½"	1,459.99
(LA)	300 Win. Mag.	24"	031023229	4	7 lbs. 8 oz.	44"	—	¾"	1½"	13¾"	1 in 10"	1,459.99
BAR SHORTRAC STALKER (SHOWN ON PAGE 76)												
(SA)	243 Win.	22"	031330211	5	6 lbs. 10 oz.	41½"	—	¾"	1½"	13¾"	1 in 10"	\$1,259.99
(SA)	7mm-08 Rem.	22"	031330216	5	6 lbs. 10 oz.	41½"	—	¾"	1½"	13¾"	1 in 9½"	1,259.99
(SA)	308 Win.	22"	031330218	5	6 lbs. 10 oz.	41½"	—	¾"	1½"	13¾"	1 in 12"	1,259.99
(SA)	270 WSM	23"	031330248	4	7 lbs. 4 oz.	42½"	—	¾"	1½"	13¾"	1 in 10"	1,349.99
(SA)	7mm WSM	23"	031330249	4	7 lbs. 4 oz.	42½"	—	¾"	1½"	13¾"	1 in 9½"	1,349.99
(SA)	300 WSM	23"	031330246	4	7 lbs. 4 oz.	42½"	—	¾"	1½"	13¾"	1 in 10"	1,349.99
(SA)	325 WSM	23"	031330277	4	7 lbs. 4 oz.	42½"	—	¾"	1½"	13¾"	1 in 10"	1,349.99
BAR LONGTRAC STALKER (SHOWN ON PAGE 76)												
(LA)	270 Win.	22"	031331224	5	6 lbs. 15 oz.	42"	—	¾"	1½"	13¾"	1 in 10"	\$1,259.99
(LA)	30-06 Sprg.	22"	031331226	5	6 lbs. 15 oz.	42"	—	¾"	1½"	13¾"	1 in 10"	1,259.99
(LA)	7mm Rem. Mag.	24"	031331227	4	7 lbs. 8 oz.	44"	—	¾"	1½"	13¾"	1 in 9½"	1,339.99
(LA)	300 Win. Mag.	24"	031331229	4	7 lbs. 8 oz.	44"	—	¾"	1½"	13¾"	1 in 10"	1,339.99

NOTE: *Total capacity includes one round in the chamber. **Weights listed are approximate. ***Measured from centerline of bore.



SHORT TRAC



BAR SHORTTRAC® STALKER NON-GLARE COMPOSITE FINISH STOCK AND FOREARM

RECEIVER Aircraft-grade alloy • Matte blued finish • Drilled and tapped for scope mounts

BARREL Matte blued finish • Hammer-forged **ACTION** Gas-operated autoloader • Multi-lug rotary bolt

• Detachable box magazine • Composite trigger guard and floorplate • Crossbolt safety

STOCK Composite • Matte black finish • Gripping panels • Shim adjustable for cast on/off and drop

at comb **FEATURES** Sling swivel studs installed • Interchangeable recoil pad



LONG TRAC

BAR LONGTRAC® STALKER

NON-GLARE COMPOSITE FINISH STOCK AND FOREARM

RECEIVER Aircraft-grade alloy • Matte blued finish • Drilled and tapped for scope

mounts **BARREL** Matte blued finish • Hammer-forged **ACTION** Gas-operated

autoloader • Multi-lug rotary bolt • Detachable box magazine • Composite

trigger guard and floorplate • Crossbolt safety **STOCK** Composite • Matte black

finish • Gripping panels • Shim adjustable for cast on/off and drop at comb

FEATURES Sling swivel studs installed • Interchangeable recoil pad



BAR EXTRA MAGAZINES

CALIBER	CODE NUMBER	SUGG. RETAIL
MARK II, SAFARI AND LIGHTWEIGHT STALKER		
243 Win. and 308 Win.	112025011	\$69.99
270 WSM	112025041	69.99
7mm WSM	112025042	69.99
300 WSM	112025030	69.99
LONGTRAC, BAR MARK II, SAFARI AND LIGHTWEIGHT STALKER		
270 Win., 25-06 Rem., 30-06 Sprg.	112025024	\$69.99
300 Win. Mag.	112025029	69.99
338 Win. Mag.	112025031	69.99
7mm Rem. Mag.	112025027	69.99
SHORTTRAC		
243 Win. and 308 Win.	112025050	\$69.99
7mm-08 Rem. Recoil Pad	112025051	69.99
270 WSM	112025055	69.99
7mm WSM	112025055	69.99
300 WSM	112025055	69.99
325 WSM	112025052	69.99

THE BROWNING BAR. TAILORED FOR PERFORMANCE.

With over ten calibers in ten models to choose from, we have an accurate, dependable Browning BAR ready for your next hunt. From elegant guns you will be proud to pass to the next generation, to rugged composite models that can take the punishment nature hands out, we offer the world's finest autoloading rifles.



BAR SHORTTRAC® AND LONGTRAC® RECOIL PADS (FOR WOOD AND COMPOSITE MODELS)

DESCRIPTION	CODE NUMBER	SUGG. RETAIL
½" BAR ST/LT Recoil Pad	11450	\$29.99
¾" BAR ST/LT Recoil Pad	11451	29.99
1" BAR ST/LT Recoil Pad	11452	29.99

PAD Black, polymer cushion

TOP INSERT Hard polypropylene

REINFORCEMENT Black, glass-fiber reinforced synthetic

THICKNESS Choice of ½", ¾" or 1"



BAR LIGHTWEIGHT STALKER

NON-GLARE COMPOSITE FINISH STOCK AND FOREARM

RECEIVER Aircraft-grade alloy • Matte blued finish • Drilled and tapped for scope mounts **BARREL** Matte blued finish • Hammer-forged • Adjustable open sights **ACTION** Gas-operated autoloader • Multi-lug rotary bolt • Detachable box magazine • Crossbolt safety

STOCK Composite • Matte black finish • Checkered

FEATURES Sling swivel studs installed • Recoil pad



BAR MK II SAFARI

GLOSS FINISH STOCK AND FOREARM

RECEIVER Steel • Blued finish • Scroll engraving • Drilled and tapped for scope mounts

BARREL Blued finish • Hammer-forged **ACTION** Gas-operated autoloader • Multi-lug rotary bolt • Detachable box magazine • Crossbolt safety **STOCK** Select gloss finish walnut

• Rounded forearm • Checkered **FEATURES** Sling swivel studs installed • Recoil pad

• Available with BOSS® device, BOSS-CR device optional (Scope and mounts not included)



CALIBER	BARREL LENGTH	CODE NUMBER	*TOTAL CAPACITY	**AVG. WEIGHT	OVERALL LENGTH	SIGHT RADIUS	***DROP AT COMB	DROP AT HEEL	LENGTH OF PULL	RATE OF TWIST	SUGG. RETAIL
BAR LIGHTWEIGHT STALKER											
243 Win.	20"	031008111	5	6 lbs. 14 oz.	41"	16"	3/4"	1 1/8"	13 3/4"	1 in 10"	\$1,229.99
308 Win.	20"	031008118	5	6 lbs. 14 oz.	41"	16"	3/4"	1 1/8"	13 3/4"	1 in 12"	1,229.99
270 WSM	23"	031008148	3	7 lbs. 1 oz.	44"	18 1/2"	3/4"	1 1/8"	13 3/4"	1 in 10"	1,339.99
7mm WSM	23"	031008149	3	7 lbs. 1 oz.	44"	18 1/2"	3/4"	1 1/8"	13 3/4"	1 in 9 1/2"	1,339.99
300 WSM	23"	031008146	3	7 lbs. 1 oz.	44"	18 1/2"	3/4"	1 1/8"	13 3/4"	1 in 10"	1,339.99
270 Win.	22"	031008124	5	7 lbs.	43"	17 1/2"	3/4"	1 1/8"	13 3/4"	1 in 10"	1,229.99
30-06 Sprg.	22"	031008126	5	7 lbs.	43"	17 1/2"	3/4"	1 1/8"	13 3/4"	1 in 10"	1,229.99
300 Win. Mag.	24"	031008129	4	7 lbs. 2 oz.	45"	19 1/2"	3/4"	1 1/8"	13 3/4"	1 in 10"	1,339.99
338 Win. Mag.	24"	031008131	4	7 lbs. 2 oz.	45"	19 1/2"	3/4"	1 1/8"	13 3/4"	1 in 10"	1,339.99
BAR MK II SAFARI											
243 Win.	22"	031001211	5	7 lbs. 8 oz.	43"	—	3/4"	1 1/8"	13 3/4"	1 in 10"	\$1,229.99
308 Win.	22"	031001218	5	7 lbs. 8 oz.	43"	—	3/4"	1 1/8"	13 3/4"	1 in 12"	1,229.99
25-06 Rem.	24"	031001223	5	7 lbs. 10 oz.	45"	—	3/4"	1 1/8"	13 3/4"	1 in 10"	1,229.99
270 Win.	22"	031001224	5	7 lbs. 8 oz.	43"	—	3/4"	1 1/8"	13 3/4"	1 in 10"	1,229.99
30-06 Sprg.	22"	031001226	5	7 lbs. 8 oz.	43"	—	3/4"	1 1/8"	13 3/4"	1 in 10"	1,229.99
7mm Rem. Mag.	24"	031001227	4	8 lbs. 10 oz.	45"	—	3/4"	1 1/8"	13 3/4"	1 in 9 1/2"	1,349.99
300 Win. Mag.	24"	031001229	4	8 lbs. 10 oz.	45"	—	3/4"	1 1/8"	13 3/4"	1 in 10"	1,349.99
338 Win. Mag.	24"	031001231	4	8 lbs. 10 oz.	45"	—	3/4"	1 1/8"	13 3/4"	1 in 10"	1,349.99
BAR MK II SAFARI WITH BOSS (SHOWN)											
270 WSM	23"	031001348	3	8 lbs. 4 oz.	44"	—	3/4"	1 1/8"	13 3/4"	1 in 10"	\$1,499.99
7mm WSM	23"	031001349	3	8 lbs. 4 oz.	44"	—	3/4"	1 1/8"	13 3/4"	1 in 9 1/2"	1,499.99
300 WSM	23"	031001346	3	8 lbs. 4 oz.	44"	—	3/4"	1 1/8"	13 3/4"	1 in 10"	1,499.99
270 Win.	22"	031001324	5	7 lbs. 6 oz.	43"	—	3/4"	1 1/8"	13 3/4"	1 in 10"	1,389.99
30-06 Sprg.	22"	031001326	5	7 lbs. 6 oz.	43"	—	3/4"	1 1/8"	13 3/4"	1 in 10"	1,389.99
7mm Rem. Mag.	24"	031001327	4	8 lbs. 6 oz.	45"	—	3/4"	1 1/8"	13 3/4"	1 in 9 1/2"	1,499.99
300 Win. Mag.	24"	031001329	4	8 lbs. 6 oz.	45"	—	3/4"	1 1/8"	13 3/4"	1 in 10"	1,499.99
338 Win. Mag.	24"	031001331	4	8 lbs. 6 oz.	45"	—	3/4"	1 1/8"	13 3/4"	1 in 10"	1,499.99

NOTE: *Total capacity includes one round in the chamber. **Weights listed are approximate. ***Measured from centerline of bore.

A RIMFIRE THOROUGHbred.

To pick up the one-of-a-kind T-Bolt is to want one. More often than not, "rimfire" is associated with entry level. Not here. These rifles are elegant, built to our highest standards of quality and immensely fun to shoot. The unique straight-pull bolt cycles fast and locks up tightly for unmatched accuracy.



Buttstock Magazine Storage

STOCK

Available in both right- and left-hand models, T-Bolt rifle stocks are full-size to comfortably fit adults. Durable Composite models feature a Monte Carlo comb and include magazine storage in the buttstock. Walnut stocked Sporter models feature trim dimensions with a satin finish and cut checkering. Walnut Target/Varmint models feature a Monte Carlo comb and wide forearm for stability on the bench. All models include dual action screws for solid attachment, sling swivel studs and a synthetic buttplate.



TRIGGER

The three-lever trigger design combined with a short-travel firing pin give a crisp break, quick lock time, no take-up and minimal overtravel. It is also externally adjustable for pull weight.

ACTION

Receiver is machined from steel barstock. Features crossbolt lockup and an enlarged bolt handle pivot point moved forward for smoother action. The mainspring runs directly through the massive pivot pin. Cocking effort is split between opening and closing for ease of operation. The bolt features dual extractors and a red cocking indicator band. Right-side ejection on both right- and left-hand models.



SAFETY

Top-tang, thumb operated two-position safety can be operated without changing from a shooting grip.

BARREL

Target/Varmint models feature a 22" heavy varmint profile. T-Bolt Sporter models feature a 22" medium sporter profile. All are free-floating and have a semi-match chamber and target muzzle crown.

SIGHTS

Receiver is drilled and tapped for scope mounts. (Scope and mounts not included.) See page 142 for scope rings and bases for T-Bolt rifles.



T-BOLT COMPOSITE SPORTER NON-GLARE COMPOSITE FINISH STOCK

RECEIVER Steel • Blued finish • Drilled and tapped for scope mounts **BARREL** Medium sporter • Blued finish • Free-floating • Semi-match chamber • Recessed crown **ACTION** Straight pull bolt-action • Top-tang safety • Adjustable trigger • Right- and left-hand models have right side ejection **STOCK** Composite • Textured gripping surfaces • Matte black • Spare magazine storage compartment **FEATURES** Sling swivel studs installed (Scope and mounts not included)



T-BOLT COMPOSITE TARGET/VARMINT NON-GLARE COMPOSITE FINISH STOCK

RECEIVER Steel • Blued finish • Drilled and tapped for scope mounts **BARREL** Medium target • Blued finish • Free-floating • Semi-match chamber • Recessed crown **ACTION** Straight pull bolt-action • Top-tang safety • Adjustable trigger • Right- and left-hand models have right side ejection **STOCK** Composite • Textured gripping surfaces • Matte black • Spare magazine storage compartment **FEATURES** Sling swivel studs installed (Scope and mounts not included)



MAGAZINE

Our patented Double Helix® rotary box magazine uses torsion spring driven interlocking gears for added reliability and easy loading and unloading. 10-round capacity.



17 HMR/
22 WMR

22 Long Rifle



DOUBLE HELIX MAGAZINES

CALIBER	CODE NUMBER	SUGG. RETAIL
22 L.R.	112055290	\$49.99
17 HMR/22 WMR	112055291	49.99

CALIBER	BARREL LENGTH	CODE NUMBER	*TOTAL CAPACITY	**AVG. WEIGHT	OVERALL LENGTH	SIGHT RADIUS	***DROP AT COMB	DROP AT HEEL	LENGTH OF PULL	RATE OF TWIST	SUGG. RETAIL
T-BOLT COMPOSITE SPORTER (SHOWN)											
22 L.R.	22"	025179202	11	4 lbs. 9 oz.	40 1/4"	---	5/8"	5/8"	13 1/2"	1 in 16"	\$749.99
22 WMR	22"	025179204	11	4 lbs. 9 oz.	40 1/4"	---	5/8"	5/8"	13 1/2"	1 in 16"	789.99
17 HMR	22"	025179270	11	4 lbs. 9 oz.	40 1/4"	---	5/8"	5/8"	13 1/2"	1 in 9"	789.99
T-BOLT COMPOSITE SPORTER, LEFT-HAND											
22 L.R.	22"	025186202	11	4 lbs. 9 oz.	40 1/4"	---	5/8"	5/8"	13 1/2"	1 in 16"	\$759.99
22 WMR	22"	025186204	11	4 lbs. 9 oz.	40 1/4"	---	5/8"	5/8"	13 1/2"	1 in 16"	799.99
17 HMR	22"	025186270	11	4 lbs. 9 oz.	40 1/4"	---	5/8"	5/8"	13 1/2"	1 in 9"	799.99
T-BOLT COMPOSITE TARGET/VARMINT (SHOWN)											
22 L.R.	22"	025180202	11	5 lbs. 2 oz.	40 1/4"	---	5/8"	5/8"	13 1/2"	1 in 16"	\$779.99
22 WMR	22"	025180204	11	5 lbs. 2 oz.	40 1/4"	---	5/8"	5/8"	13 1/2"	1 in 16"	799.99
17 HMR	22"	025180270	11	5 lbs. 2 oz.	40 1/4"	---	5/8"	5/8"	13 1/2"	1 in 9"	799.99
T-BOLT COMPOSITE TARGET/VARMINT, LEFT-HAND											
22 L.R.	22"	025187202	11	5 lbs. 2 oz.	40 1/4"	---	5/8"	5/8"	13 1/2"	1 in 16"	\$799.99
22 WMR	22"	025187204	11	5 lbs. 2 oz.	40 1/4"	---	5/8"	5/8"	13 1/2"	1 in 16"	829.99
17 HMR	22"	025187270	11	5 lbs. 2 oz.	40 1/4"	---	5/8"	5/8"	13 1/2"	1 in 9"	829.99

NOTE: *Total capacity includes one round in the chamber. **Weights listed are approximate. ***Measured from centerline of bore.

T-Bolt Sporter, Right-Hand



T-Bolt Sporter, Left-Hand



T-BOLT SPORTER SATIN FINISH STOCK

RECEIVER Steel • Blued finish • Drilled and tapped for scope mounts **BARREL** Medium sporter • Blued finish • Free-floating • Semi-match chamber • Recessed crown **ACTION** Straight pull bolt-action • Top-tang safety • Adjustable trigger • Right- and left-hand models have right side ejection **STOCK** Satin finish walnut • Checkered **FEATURES** Sling swivel studs installed



T-BOLT TARGET/VARMINT SATIN FINISH STOCK

RECEIVER Steel • Blued finish • Drilled and tapped for scope mounts **BARREL** Medium target • Blued finish • Free-floating • Semi-match chamber • Recessed crown **ACTION** Straight pull bolt-action • Top-tang safety • Adjustable trigger • Right- and left-hand models have right side ejection **STOCK** Satin finish walnut • Monte Carlo comb • Wide fore-end • Checkered **FEATURES** Sling swivel studs installed (Scope and mounts not included)



CALIBER	BARREL LENGTH	CODE NUMBER	*TOTAL CAPACITY	**AVG. WEIGHT	OVERALL LENGTH	SIGHT RADIUS	***DROP AT COMB	DROP AT HEEL	LENGTH OF PULL	RATE OF TWIST	SUGG. RETAIL
T-BOLT SPORTER											
22 L.R.	22"	025175202	11	4 lbs. 14 oz.	40 1/4"	---	5/8"	5/8"	13 1/2"	1 in 16"	\$749.99
22 WMR	22"	025175204	11	4 lbs. 14 oz.	40 1/4"	---	5/8"	5/8"	13 1/2"	1 in 16"	789.99
17 HMR	22"	025175270	11	4 lbs. 14 oz.	40 1/4"	---	5/8"	5/8"	13 1/2"	1 in 9"	789.99
T-BOLT SPORTER, LEFT-HAND											
22 L.R.	22"	025184202	11	4 lbs. 14 oz.	40 1/4"	---	5/8"	5/8"	13 1/2"	1 in 16"	\$759.99
22 WMR	22"	025184204	11	4 lbs. 14 oz.	40 1/4"	---	5/8"	5/8"	13 1/2"	1 in 16"	799.99
17 HMR	22"	025184270	11	4 lbs. 14 oz.	40 1/4"	---	5/8"	5/8"	13 1/2"	1 in 9"	799.99
T-BOLT TARGET/VARMINT (SHOWN)											
22 L.R.	22"	025176202	11	5 lbs. 8 oz.	40 1/4"	---	5/8"	5/8"	13 1/2"	1 in 16"	\$779.99
22 WMR	22"	025176204	11	5 lbs. 8 oz.	40 1/4"	---	5/8"	5/8"	13 1/2"	1 in 16"	799.99
17 HMR	22"	025176270	11	5 lbs. 8 oz.	40 1/4"	---	5/8"	5/8"	13 1/2"	1 in 9"	799.99
T-BOLT TARGET/VARMINT, LEFT-HAND											
22 L.R.	22"	025185202	11	5 lbs. 8 oz.	40 1/4"	---	5/8"	5/8"	13 1/2"	1 in 16"	\$799.99
22 WMR	22"	025185204	11	5 lbs. 8 oz.	40 1/4"	---	5/8"	5/8"	13 1/2"	1 in 16"	829.99
17 HMR	22"	025185270	11	5 lbs. 8 oz.	40 1/4"	---	5/8"	5/8"	13 1/2"	1 in 9"	829.99

NOTE: *Total capacity includes one round in the chamber. **Weights listed are approximate. ***Measured from centerline of bore.

LEVER-ACTION PERFORMANCE AND FUN.

Highly accurate and quick handling, a Browning BL-22 will win your heart. These time-tested favorites include performance features like ultra short 33° lever throw for fast action — even with small hands — and the same Browning quality that is never compromised.



Eligible for the Growth Insurance Program. See page 54 for details.

BL-22 GRADE I MICRO MIDAS GLOSS FINISH STOCK AND FOREARM

RECEIVER Steel • Blued finish • Grooved for scope mounts **BARREL** Blued finish • Recessed crown **ACTION** Lever-action • Short 33° lever throw • Tubular magazine **STOCK** Gloss finish American walnut • Straight grip • Compact 12" length of pull for smaller shooters **FEATURES** Adjustable sights



BL-22 GRADE I AND II

GLOSS FINISH STOCK AND FOREARM

RECEIVER Steel • Blued finish • Grooved for scope mounts • Grade II is scroll engraved **BARREL** Blued finish • Recessed crown **ACTION** Lever-action • Short 33° lever throw • Tubular magazine • Grade II has gold-colored trigger **STOCK** Gloss finish American walnut • Straight grip • Grade II has cut checkering **FEATURES** Adjustable sights

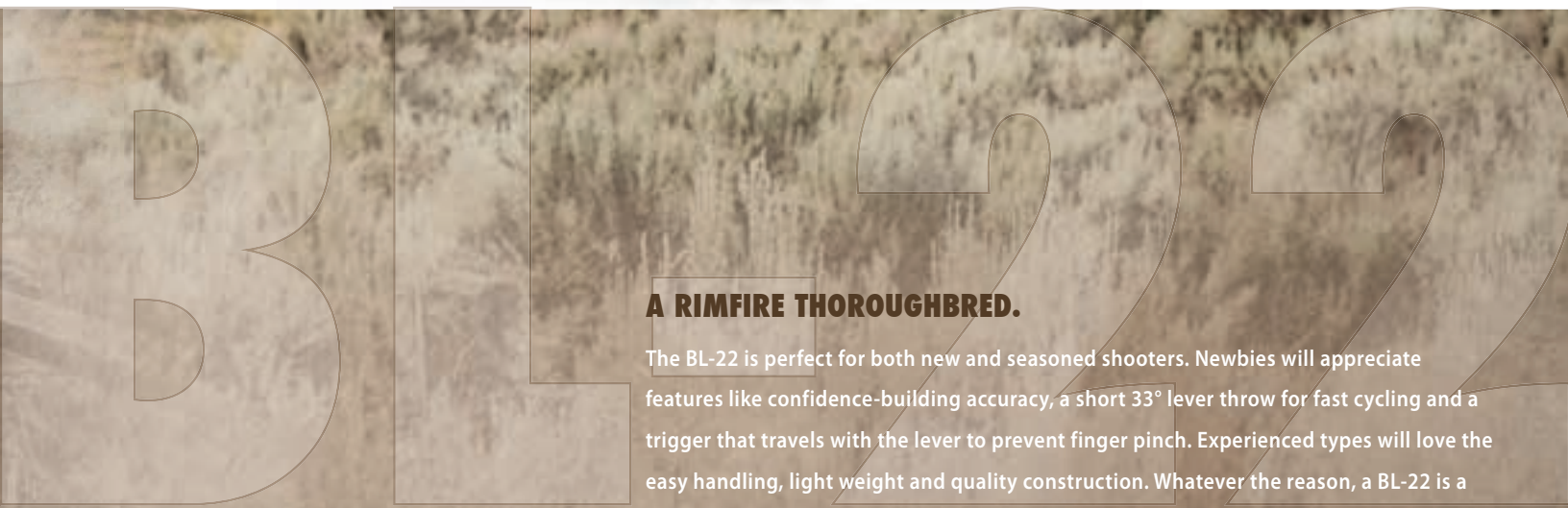

A RIMFIRE THOROUGHbred.

The BL-22 is perfect for both new and seasoned shooters. Newbies will appreciate features like confidence-building accuracy, a short 33° lever throw for fast cycling and a trigger that travels with the lever to prevent finger pinch. Experienced types will love the easy handling, light weight and quality construction. Whatever the reason, a BL-22 is a must have for every gun collection.

CALIBER	BARREL LENGTH	CODE NUMBER	*TOTAL CAPACITY	**AVG. WEIGHT	OVERALL LENGTH	SIGHT RADIUS	***DROP AT COMB	DROP AT HEEL	LENGTH OF PULL	RATE OF TWIST	SUGG. RETAIL
BL-22 GRADE I MICRO MIDAS											
22 L.R.	16¼"	024115103	12	4 lbs. 12 oz.	31½"	11¾"	¾"	1½"	12"	1 in 16"	\$539.99
BL-22 GRADE I AND II											
Grade I 22 S, L & L.R.	20"	024100103	16 L.R.	5 lbs.	36¾"	15¾"	¾"	1½"	13½"	1 in 16"	\$619.99
(Shown) Grade II 22 S, L & L.R.	20"	024101103	16 L.R.	5 lbs.	36¾"	15¾"	¾"	1½"	13½"	1 in 16"	699.99

NOTE: *Total capacity includes one round in the chamber. **Weights listed are approximate. ***Measured from centerline of bore.



BL-22 FULL LINE DEALER, GRADE II OCTAGON SATIN FINISH STOCK AND FOREARM

RECEIVER Steel • Satin nickel finish • Grooved for scope mounts • Scroll engraved **BARREL** Octagonal • Blued finish • Recessed crown **ACTION** Lever-action • Short 33° lever throw • ¾ length tubular magazine • Gold-colored trigger **STOCK** Satin finish American walnut • Straight grip • Cut checkering **FEATURES** Adjustable sights with front gold bead • Available only from Browning Full Line and Medallion Dealers



BL-22 FULL LINE DEALER, GRADE I AND II SATIN FINISH STOCK AND FOREARM

RECEIVER Steel • Satin nickel finish • Grooved for scope mounts • Grade II is scroll engraved **BARREL** Blued finish • Recessed crown **ACTION** Lever-action • Short 33° lever throw • Tubular magazine • Grade II has gold-colored trigger **STOCK** Satin finish American walnut • Straight grip • Grade II has cut checkering **FEATURES** Adjustable sights with front bead • Available only from Browning Full Line and Medallion Dealers

	CALIBER	BARREL LENGTH	CODE NUMBER	*TOTAL CAPACITY	**AVG. WEIGHT	OVERALL LENGTH	SIGHT RADIUS	***DROP AT COMB	DROP AT HEEL	LENGTH OF PULL	RATE OF TWIST	SUGG. RETAIL
BL-22 FULL LINE DEALER, GRADE II OCTAGON												
	22 S, L & L.R.	24"	024105155	16 L.R.	5 lbs. 4 oz.	40¼"	19¾"	⅞"	1½"	13½"	1 in 16"	\$979.99
BL-22 FULL LINE DEALER, GRADE I AND II												
	Grade I 22 S, L & L.R.	20"	024107102	16 L.R.	5 lbs.	36¼"	15¾"	⅞"	1½"	13½"	1 in 16"	\$659.99
(Shown)	Grade II 22 S, L & L.R.	20"	024108102	16 L.R.	5 lbs.	36¼"	15¾"	⅞"	1½"	13½"	1 in 16"	749.99

NOTE: *Total capacity includes one round in the chamber. **Weights listed are approximate. ***Measured from centerline of bore.



A JOHN M. BROWNING ORIGINAL.

The design ingenuity of John M. Browning is the stuff of legends. Experience it for yourself with one of his original designs, the classic SA-22. Quick to the shoulder and intuitive to point, the SA-22 is an enduring legend and an honor to the greatest gun inventor that has ever lived.

ACTION

Takedown autoloader with bottom ejection.

RECEIVER

Grade I is engraved with scroll design and a polished, blued finish. Grade VI models are available in polished blued or satin grayed finish.

ENGRAVING

Grade VI models are deeply engraved with game scenes. Game figures are 24 karat gold-plated.

SIGHTS

Gold bead front and adjustable, folding leaf rear.

TRIGGER

Blued on Grade I. Gold on Grade VI.

BARREL

Drilled and tapped to accept a scope mount.

SAFETY

Manual trigger-blocking safety is mounted on the trigger guard.

MAGAZINE

Tubular. Capacity: 11 Long Rifle cartridges.

STOCK AND FOREARM

Select American walnut is checkered with a polished gloss finish.



SEMI-AUTO 22 GRADE I GLOSS FINISH STOCK AND FOREARM

RECEIVER Steel • Takedown design • Polished blued finish • Scroll engraving **BARREL** Polished blued finish • Drilled and tapped for scope mounts **ACTION** Autoloading • Bottom ejection • Tubular magazine • Crossbolt safety **STOCK** Gloss finish select American walnut • Checkered **FEATURES** Adjustable sights with gold bead front sight blade

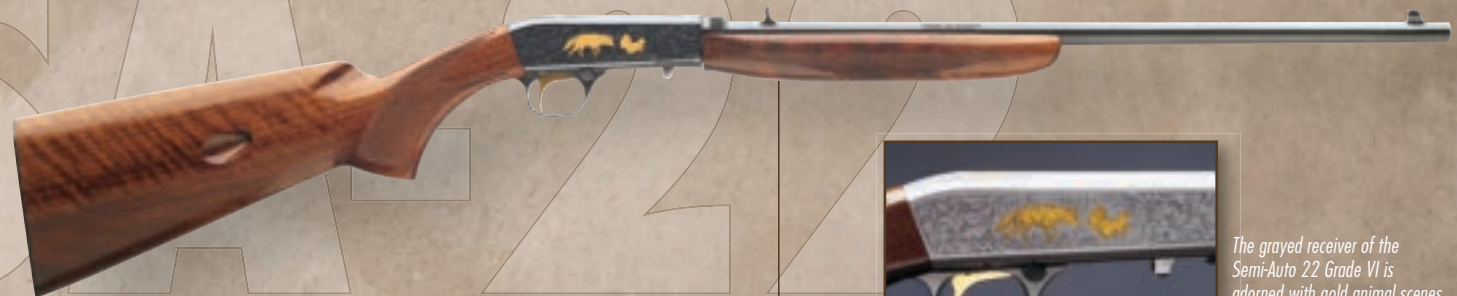

SEMI-AUTO 22 GRADE VI GLOSS FINISH STOCK AND FOREARM

- RECEIVER** Steel • Takedown design • Polished blued or satin grayed finish
- Game scene engraving with 24 karat gold accents **BARREL** Polished blued finish
 - Drilled and tapped for scope mounts **ACTION** Autoloading • Bottom ejection
 - Tubular magazine • Crossbolt safety **STOCK** Gloss finish select American walnut
 - Checkered **FEATURES** Adjustable sights with gold bead front sight blade



The grayed receiver of the Semi-Auto 22 Grade VI is adorned with gold animal scenes.



The Semi-Auto 22 can be quickly taken down to a compact length of only 19 3/8" for storage or packing.

CALIBER	BARREL LENGTH	CODE NUMBER	*TOTAL CAPACITY	**AVG. WEIGHT	OVERALL LENGTH	SIGHT RADIUS	***DROP AT COMB	DROP AT HEEL	LENGTH OF PULL	RATE OF TWIST	SUGG. RETAIL
SEMI-AUTO 22 GRADE I											
22 L.R.	19 3/8"	021001102	11	5 lbs. 3 oz.	37"	16 1/4"	1 3/8"	2 3/8"	13 3/4"	1 in 16"	\$699.99
SEMI-AUTO 22 GRADE VI											
Blued 22 L.R.	19 3/8"	021002102	11	5 lbs. 3 oz.	37"	16 1/4"	1 3/8"	2 3/8"	13 3/4"	1 in 16"	\$1,579.99
Grayed 22 L.R.	19 3/8"	021003102	11	5 lbs. 3 oz.	37"	16 1/4"	1 3/8"	2 3/8"	13 3/4"	1 in 16"	1,579.99

NOTE: *Total capacity includes one round in the chamber. **Weights listed are approximate. ***Measured from centerline of bore.



ONE FUN LITTLE GUN.

The Buck Mark Rifle is compact, easy to shoot and always ready to hunt squirrels and rabbits, or tip over aluminum cans. Lightweight, accurate and extremely reliable, the Buck Mark Rifle is tough to put down for any reason except to reload.



ACTION

The straight blowback design offers enhanced simplicity and reliability.

FRAME

Machined to exacting tolerances from a solid billet of 7075-T6 aluminum. The stock structure is a part of the pistol frame, reducing weight and the number of parts.

SLIDE

Built-in recess and raised side panels for an improved cocking grip. The convenient manual slide release is easily operated with the shooting or support hand.



SIGHTS

Sporter models feature a TRUGLO®/Marble® fiber-optic sight system.

BARREL

Sporter model features a lightweight, tapered sporter-weight barrel. Target models feature a steel bull barrel. The chamber in every Buck Mark Rifle barrel is hand-reamed and the muzzle crown is recessed to protect it from damage that could degrade accuracy.



SAFETY

Large manual thumb safety.

MAGAZINE RELEASE

Positioned adjacent to the trigger guard for convenient operation.





Made in the USA



GRAY LAMINATE BUCK MARK TARGET RIFLE, FLD

SATIN FINISH STOCK AND FOREARM

RECEIVER Alloy • Matte blued finish **BARREL** Heavy bull • Matte blued finish • Target crown **ACTION** Blowback • Single-action trigger • Detachable magazine **STOCK** Laminated gray satin finish hardwood **FEATURES** Integral scope rail • Available only from Browning Full Line and Medallion Dealers



BUCK MARK TARGET RIFLE OIL FINISH STOCK AND FOREARM

RECEIVER Alloy • Matte blued finish **BARREL** Heavy bull • Matte blued finish • Target crown **ACTION** Blowback • Single-action trigger • Detachable magazine **STOCK** Oil finish walnut **FEATURES** Integral scope rail (Reflex sight not included)



BUCK MARK SPORTER RIFLE OIL FINISH STOCK AND FOREARM

RECEIVER Alloy • Matte blued finish **BARREL** Tapered sporter • Matte blued finish • Target crown **ACTION** Blowback • Single-action trigger • Detachable magazine **STOCK** Oil finish walnut **FEATURES** TRUGLO®/Marble's® adjustable fiber-optic sights • Integral scope rail

CALIBER	BARREL LENGTH	CODE NUMBER	*TOTAL CAPACITY	**AVG. WEIGHT	OVERALL LENGTH	SIGHT RADIUS	***DROP AT COMB	DROP AT HEEL	LENGTH OF PULL	RATE OF TWIST	SUGG. RETAIL
BUCK MARK FULL LINE DEALER TARGET GRAY LAMINATE RIFLE											
22 L.R.	18"	021030202	11	5 lbs. 8 oz.	33½"	—	7/8"	1½"	15½"	1 in 16"	\$699.99
BUCK MARK TARGET RIFLE											
22 L.R.	18"	021025202	11	5 lbs. 6 oz.	33½"	—	7/8"	1½"	15½"	1 in 16"	\$669.99
BUCK MARK SPORTER RIFLE											
22 L.R.	18"	021026102	11	4 lbs. 6 oz.	33½"	12¾"	7/8"	1½"	15½"	1 in 16"	\$669.99

NOTE: *Total capacity includes one round in the chamber. **Weights listed are approximate. ***Measured from centerline of bore.



GET YOUR HANDS ON 85% OF THE GREATEST PISTOL IN HISTORY.

John M. Browning developed the Model 1911 to fire the powerful 45 ACP cartridge. We developed it to fire the 22 L.R. and, after extensive testing and research, determined that 85% of the original size was ideal for the smaller cartridge. Put one in your hands and we know that you'll agree. The grip is comfortable even in large hands and feels equally at home in smaller ones. The lightweight alloy construction is anything but light duty. Own a little piece of history today.

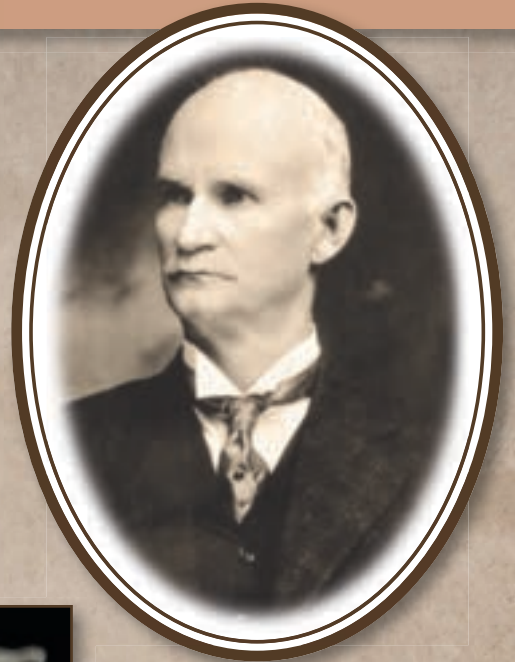

ACTION

The straight blowback design offers enhanced simplicity and reliability.

FRAME

Machined from aircraft-grade aluminum to exacting tolerances.

SLIDE

Vertical serrations provide an improved cocking grip. The convenient manual slide release is easily operated with the shooting or support hand.

SAFETY

Large manual thumb safety and grip safety.

MAGAZINE

The steel magazine body is heat-treated for long-term feeding reliability and long life. Our coil spring provides a consistent follower angle. 10-round capacity.

MAGAZINE RELEASE

Positioned adjacent to the trigger guard for convenient operation.



All Browning firearms are shipped with a free locking device to assist in the safe storage of firearms.

Manual thumb safety and grip safety.



Slide serrations provide a secure grip.



Magazine release is positioned adjacent to the trigger guard for ease of use.

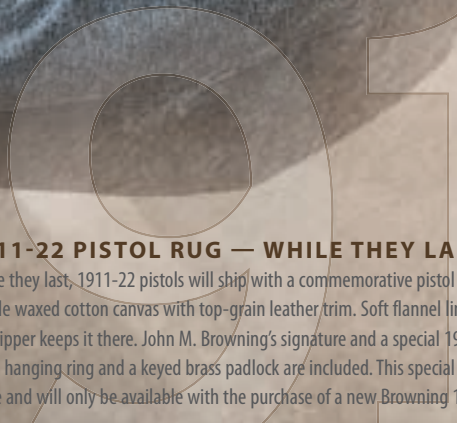

1911-22 PISTOL RUG — WHILE THEY LAST!

While they last, 1911-22 pistols will ship with a commemorative pistol rug. These top quality rugs are made from supple waxed cotton canvas with top-grain leather trim. Soft flannel lining protects the pistol inside and a nylon coil zipper keeps it there. John M. Browning's signature and a special 1911-2011 logo adorns the outside. A solid brass hanging ring and a keyed brass padlock are included. This special commemorative pistol rug is a \$49.99 retail value and will only be available with the purchase of a new Browning 1911-22 while supplies last.



Right Side View



Left Side View

1911-22 A1 PISTOL

FRAME Alloy • Matte blued finish **SLIDE** Machined aluminum • Matte blued finish **BARREL** 4¼" length • Stainless steel barrel block • Matte blued finish • Target crown **ACTION** Blowback • Single-action trigger **GRIPS** Brown composite **FEATURES** Fixed sights • Detachable 10-round magazine • Manual thumb safety • Grip safety



Made in the USA

1911-22 COMPACT PISTOL

FRAME Alloy • Matte blued finish **SLIDE** Machined aluminum • Matte blued finish **BARREL** 3⅜" length • Stainless steel barrel block • Matte blued finish • Target crown **ACTION** Blowback • Single-action trigger **GRIPS** Brown composite **FEATURES** Fixed sights • Detachable 10-round magazine • Manual thumb safety • Grip safety

1911-22 Magazine, .22 Long Rifle



You will find a familiar friend in the 1911-22 pistol. All controls operate just as those on the original John M. Browning-designed Model 1911.

1911-22 EXTRA MAGAZINES

CALIBER	CODE NUMBER	SUGG. RETAIL
22 L.R.	112055191	\$39.99

MODEL	CALIBER	FINISH	GRIPS	BARREL LENGTH	CODE NUMBER	*AVG. WEIGHT	OVERALL LENGTH	SIGHT RADIUS	SUGG. RETAIL
A1	22 L.R.	Matte Black	Brown Composite	4¼"	051802490	15½ oz.	7⅞"	5½"	\$599.99
Compact	22 L.R.	Matte Black	Brown Composite	3⅜"	051803490	15 oz.	6½"	4⅞"	\$99.99



BUCK MARK® PRECISION.

Precisely made and a blast to shoot, the affordable Buck Mark is proudly "Made in the USA" and features a machined aluminum frame, precision rifled barrel, smooth trigger and fully-adjustable sights. More than accurate enough for serious competition or an afternoon plinking at the range, the versatile Buck Mark is always game for a good time.



BUCK MARK PLUS UDX

- RECEIVER** Alloy • Matte blued finish • Finger grooves
- BARREL** Slabside • Matte blued finish • 5½" length
- ACTION** Blowback • Single-action trigger
- GRIPS** Walnut Ultragrip DX® ambidextrous
- FEATURES** Pro-Target™ adjustable rear sight • TRUGLO®/Marble's® fiber-optic front sight



Pro-Target rear sight offers finer adjustment clicks for greater accuracy.



Ultragrip RX® adds control and comfort.





ACTION

The straight blowback design offers enhanced simplicity and reliability.

SLIDE

Built-in recess and raised side panels for improved cocking grip. The convenient manual slide release is easily operated with your shooting or support hand.

BARREL

Most models have bull barrels for improved stability. Lite models have a steel barrel liner inside an ultralight aluminum sleeve. The chamber is hand-reamed and the muzzle crown is recessed to protect it from damage that could degrade accuracy.

REAR SIGHT

A 16-click per revolution adjustable Pro-Target™ sight is standard on all models. This sight provides a finer range of adjustment over the industry's standard of 12-clicks per revolution.

FRONT SIGHT

Plus models feature a TRUGLO®/Marble's® fiber-optic front sight.



BUCK MARK LITE GREEN/GRAY

RECEIVER Alloy • Matte green or gray finish **BARREL** Alloy sleeved • Matte green or gray finish • Fluted • Available in 5½" length **ACTION** Blowback • Single-action trigger **GRIPS** Ultragrip RX® ambidextrous **FEATURES** Pro-Target™ adjustable rear sight • TRUGLO®/Marble's® fiber-optic front sight

BUCK MARK PRACTICAL URX

RECEIVER Alloy • Matte gray finish
BARREL Tapered bull 5½" • Matte blued finish
ACTION Blowback • Single-action trigger
GRIPS Ultragrip RX® ambidextrous
FEATURES Pro-Target™ adjustable rear sight • TRUGLO®/Marble's® fiber-optic front sight

FRAME

While many popular 22 pistols are cast or fabricated from sheet metal stampings, each Buck Mark frame is CNC machined from 7075-T6 aluminum to exacting tolerances.

MAGAZINE

The magazine body is heat-treated for long-term feeding reliability. Coil spring provides more consistent follower angle. 10-round capacity.

MAGAZINE RELEASE

Positioned adjacent to the trigger guard for convenient operation.

TRIGGER

Compare it to the competition and feel its light, crisp break with less creep and overtravel.

SAFETY

Large, manual thumb safety. The trigger is disconnected when the magazine is removed for added safety.

GRIPS

Several wood, laminate and composite styles are available. Soft nitrile rubber Ultragrip RX® (URX) and wood Ultragrip Deluxe® (UDX) ambidextrous grips have ergonomic finger grooves for enhanced control.

MODEL	FINISH	GRIPS	BARREL LENGTH	CODE NUMBER	*AVG. WEIGHT	OVERALL LENGTH	SIGHT RADIUS	SUGG. RETAIL
Lite Green 5.5	Matte Green	URX Ambidextrous	5½"	051459490	28 oz.	9½"	8"	\$559.99
Lite Gray 5.5 (shown)	Matte Gray	URX Ambidextrous	5½"	051461490	28 oz.	9½"	8"	559.99
Practical URX	Matte Gray	URX Ambidextrous	5½"	051448490	34 oz.	9½"	8"	429.99
Plus UDX	Matte Blued	Brown Laminate UDX, Ambidextrous	5½"	051428490	34 oz.	9½"	8"	519.99

NOTE: *Weights listed are approximate.

EXTRA MAGAZINES

CALIBER	CODE NUMBER	SUGG. RETAIL
22 L.R.	112055190	\$29.99



**BUCK MARK PLUS
STAINLESS UDX**

RECEIVER Alloy • Matte blued finish • Finger grooves
BARREL Stainless slabside • Matte finish • 5½" length
ACTION Blowback • Single-action trigger **GRIPS** Black laminated Ultragrip DX® ambidextrous
FEATURES Pro-Target™ adjustable rear sight • TRUGLO®/Marble's® fiber-optic front sight



**BUCK MARK PLUS
ROSEWOOD UDX, FLD**

RECEIVER Alloy • Matte blued finish • Finger grooves
BARREL Slabside • Matte blued finish • 5½" length
ACTION Blowback • Single-action trigger
GRIPS Rosewood Ultragrip DX® ambidextrous
FEATURES Pro-Target™ adjustable rear sight • TRUGLO®/Marble's® fiber-optic front sight • Available only from Browning Full Line and Medallion Dealers



**BUCK MARK CAMPER
STAINLESS URX, FLD**

RECEIVER Alloy • Matte blued finish **BARREL** Stainless tapered bull 5½" • Matte finish **ACTION** Blowback • Single-action trigger **GRIPS** Ultragrip RX® ambidextrous **FEATURES** Pro-Target™ adjustable rear sight • TRUGLO®/Marble's® fiber-optic front sight • Available only from Browning Full Line and Medallion Dealers



BUCK MARK CAMPER

RECEIVER Alloy • Matte blued finish
BARREL Tapered bull 5½" • Matte blued finish
ACTION Blowback • Single-action trigger
GRIPS Black composite **FEATURES** Pro-Target™ adjustable sights



BUCK MARK CAMPER STAINLESS

RECEIVER Alloy • Matte blued finish **BARREL** Stainless tapered bull 5½" • Matte finish **ACTION** Blowback • Single-action trigger **GRIPS** Black composite **FEATURES** Pro-Target™ adjustable sights



BUCK MARK STANDARD URX

RECEIVER Alloy • Matte blued finish
BARREL Slabside • Matte blued finish with polished flats • Available in Standard 5½" and Micro 4" **ACTION** Blowback • Single-action trigger **GRIPS** Ultragrip RX® ambidextrous **FEATURES** Pro-Target™ adjustable sights

MODEL	FINISH	GRIPS	BARREL LENGTH	CODE NUMBER	*AVG. WEIGHT	OVERALL LENGTH	SIGHT RADIUS	SUGG. RETAIL
Plus Stainless UDX	Matte Stainless Slide & Barrel	Black Laminate UDX, Ambidextrous	5½"	051427490	34 oz.	9½"	8"	\$559.99
Plus Rosewood UDX, FLD	Matte Blued	Rosewood UDX, Ambidextrous	5½"	051429490	34 oz.	9½"	8"	\$19.99
Camper Stainless URX, FLD	Matte Stainless Slide & Barrel	Molded Comp., Ambidextrous	5½"	051442490	34 oz.	9½"	8"	\$29.99
Camper	Matte Blued	Molded Comp., Ambidextrous	5½"	051379490	34 oz.	9½"	8"	\$79.99
Camper Stainless	Matte Stainless Slide & Barrel	Molded Comp., Ambidextrous	5½"	051381490	34 oz.	9½"	8"	\$19.99
Standard URX (shown)	Matte Blued	URX Ambidextrous	5½"	051407490	34 oz.	9½"	8"	\$59.99
Micro Standard URX	Matte Blued	URX Ambidextrous	4"	051408490	32 oz.	8"	6¼"	\$59.99

NOTE: *Weights listed are approximate.



BUCK MARK HUNTER

RECEIVER Alloy • Matte blued finish **BARREL** Heavy tapered round bull 7¼" • Matte blued finish • Integral scope base **ACTION** Blowback • Single-action trigger **GRIPS** Laminated cocobolo target **FEATURES** Pro-Target™ adjustable rear sight • TRUGLO®/Marble's® fiber-optic front sight (Browning Reflex sight not included) • Pistol rug



BUCK MARK STANDARD STAINLESS URX

RECEIVER Alloy • Matte blued finish **BARREL** Stainless slabside 5½" **ACTION** Blowback • Single-action trigger **GRIPS** Ultragrip RX® ambidextrous **FEATURES** Pro-Target™ adjustable sights (Browning Reflex sight and optional scope base not included)



The Buck Mark's straight blowback design and hand-reamed chamber add to its legendary reliability and accuracy.



7.25
Includes
Pistol Rug



Special barrel profile on Contour models.

BUCK MARK CONTOUR 5.5 AND 7.25 URX

RECEIVER Alloy • Matte blued finish **BARREL** Special contour • Matte blued finish • Full-length scope base • Available in 5½" and 7¼" **ACTION** Blowback • Single-action trigger **GRIPS** Ultragrip RX® ambidextrous **FEATURES** Pro-Target™ adjustable sights

MODEL	FINISH	GRIPS	BARREL LENGTH	CODE NUMBER	*AVG. WEIGHT	OVERALL LENGTH	SIGHT RADIUS	SUGG. RETAIL
Hunter	Matte Blued	Cocobolo, Ambidextrous	7¼"	051403490	38 oz.	11½"	9⅞"	\$479.99
Standard Stainless URX	Matte Stainless	URX Ambidextrous	5½"	051409490	34 oz.	9½"	8"	499.99
Contour 5.5 URX (shown)	Matte Blued, Polished Barrel Flats	URX Ambidextrous	5½"	051421490	36 oz.	9½"	8"	539.99
Contour 7.25 URX	Matte Blued, Polished Barrel Flats	URX Ambidextrous	7¼"	051422490	39 oz.	11½"	9⅞"	549.99

NOTE: *Weights listed are approximate.

A LEGEND YOU CAN RELY ON.

The Browning Hi Power is one of the most revered pistols of all time. This ground-breaking firearm was originally designed by John M. Browning and perfected in the years following his death by Fabrique Nationale's prolific designer, Dieudonne Saive. The Hi Power has proven itself around the world in the hands of law enforcement, military, special operations forces and law abiding citizens. Add a legendary piece of functional firearm history to your collection now with a Browning Hi Power.



SAFETY

A large, ambidextrous manual thumb safety is conveniently located on the frame just above the grip.



SIGHTS

Hi Power pistols are available with fixed, low-profile three-dot sights. The Hi Power Standard is also available with optional low-profile target sights that are adjustable for windage and elevation.



MAGAZINE CAPACITY

Double-stack magazine design. A 13-round magazine is standard in 9mm. 10-round models in 9mm are available where required by law. Follow state and local laws regarding magazine capacity.



FRAME AND SLIDE

The frame and slide are built from solid steel, yet remain lightweight. The heft of the Hi Power keeps recoil light and manageable for accurate firing, even at a rapid rate. The Hi Power's balance in your hand is impeccable.



TRIGGER

The light single-action trigger breaks clean and crisp. This is the system preferred by professionals around the world.



HI POWER MARK III (FIXED SIGHTS)

RECEIVER Steel • Black epoxy finish **BARREL** 4 $\frac{1}{2}$ " • Black epoxy on slide • Low profile fixed sights **ACTION** Locked breech • Single-action trigger • Ambidextrous thumb safety **GRIPS** Composite panels • Thumb rest **FEATURES** Extra magazine



HI POWER STANDARD

(FIXED OR ADJUSTABLE SIGHTS)

RECEIVER Steel • Polished blued finish **BARREL** 4 $\frac{1}{2}$ " • Polished blued finish on slide • Low profile fixed or adjustable rear sights with ramped front post **ACTION** Locked breech • Single-action trigger • Ambidextrous thumb safety **GRIPS** Select walnut • Cut checkering **FEATURES** Extra magazine



MODEL	FINISH	GRIPS	BARREL LENGTH	10 CAPACITY CODE NUMBER	13 CAPACITY CODE NUMBER	*AVG. WEIGHT	OVERALL LENGTH	SIGHT RADIUS	SUGG. RETAIL
HI POWER MARK III, FIXED SIGHTS (SHOWN)									
9mm	Black Epoxy	Molded Composite	4 $\frac{1}{2}$ "	051001393	051002393	32 oz.	7 $\frac{3}{4}$ "	6 $\frac{1}{2}$ "	\$1,059.99
HI POWER STANDARD, FIXED SIGHTS									
9mm	Blued	Walnut	4 $\frac{1}{2}$ "	051003393	051004393	32 oz.	7 $\frac{3}{4}$ "	6 $\frac{1}{2}$ "	\$1,069.99
HI POWER STANDARD, ADJUSTABLE SIGHTS (SHOWN)									
9mm	Blued	Walnut	4 $\frac{1}{2}$ "	051003493	051004493	32 oz.	7 $\frac{3}{4}$ "	6 $\frac{1}{2}$ "	\$1,149.99

NOTE: *Weights listed are approximate.

EXTRA MAGAZINES

CALIBER	CODE NUMBER	SUGG. RETAIL	CALIBER	CODE NUMBER	SUGG. RETAIL
HI POWER (10-SHOT CAPACITY)			HI POWER (13-SHOT CAPACITY)		
9mm, S.A., H.P., Standard	112050193	\$59.99	9mm, S.A., H.P., Standard	112050293	\$69.99
9mm, S.A., H.P., Pachmayr Pad	112051193	\$9.99	9mm, S.A., H.P., Pachmayr Pad	112051293	\$9.99
40 S&W, S.A., H.P., Standard	112050194	\$9.99			
40 S&W, S.A., H.P., Pachmayr Pad	112051194	\$9.99			



OWN A PIECE OF BROWNING HISTORY. STRAIGHT FROM THE BELGIAN CUSTOM SHOP.

John M. Browning's relationship with Fabrique Nationale began in the late 1800s, with the legendary arms factory producing many of the designer's most storied firearms. Today, hand-crafted firearms from the Browning Custom Shop in Belgium are revered as art, customized and embellished to your exacting preferences. Available firearms include the famous Superposed™, BAR® and Hi Power™, each carefully manufactured and hand-assembled to ensure your investment will be enjoyed and shared for generations. For information, call (801) 876-2711 or visit browning.com/custom to download the Custom Shop brochure and view the many options available.



Left side engraving details



DIANA™



MIDAS™



PIGEON



B25 GRADE C11



B25 GRADE D11



B25 GOLD



B25 SPECIAL DUCK



B25 GRADE B2G



B25 GRADE C12



B25 GRADE D12



B25 SPECIAL WOODCOCK



B25 EVOLUTION



B25 GRADE C2G



B25 GRADE D5G



B25 GRADE I1



B25 GRADE E1



B25 GRADE F1



B25 GRADE M1



B25 GRADE M2

*B25 Special Flowers***B25 SUPERPOSED™**

The most requested Custom Shop model is the legendary Superposed, the last design undertaken by John M. Browning before his death in 1926 and the culmination of his firearms ingenuity and wisdom. The Superposed is the finest and most respected over and under design ever. As in all of Browning's work, the Superposed delivers perfect balance, economy of proportion and eye-appealing design. As beautiful as a custom Superposed is, it deserves to be carried afield and used, just as Mr. Browning intended.

CCS 25 B5**EXPRESS RIFLES**

A solid action frame with a reinforced lock, thickened barrels and a pistol grip stock make a Browning Express rifle the perfect firearm for dangerous game hunting and African safaris. Available in 270 Win., 30-06 Sprg., 30R Blaser, 7x65R, 8x57JRS, 9.2x62 or 9.3x74R calibers.

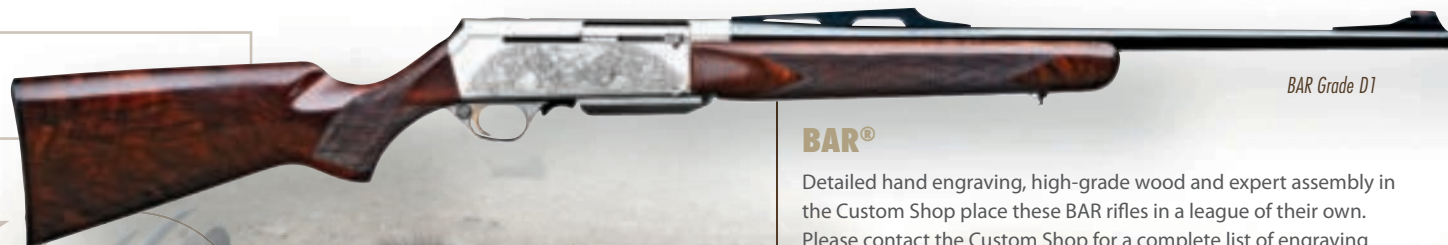
*CCS 25 Grade B2E, Left**CCS 25 Grade Bavarian, Left**CCS 25 Grade D5G, Left**CCS 25 Grade M1, Left**BAR Grade D1***BAR®**

Detailed hand engraving, high-grade wood and expert assembly in the Custom Shop place these BAR rifles in a league of their own. Please contact the Custom Shop for a complete list of engraving options. It is available in 243 Win., 25-06 Rem., 30-06 Sprg., 270 Win., 308 Win., 300 Win. Mag., 7mm Rem. Mag. or 338 Win. Mag. calibers.



SA-22 Grade III

SEMI-AUTO 22™ LUXE

An honest piece of living history, designed by The Master himself. This rimfire is particularly light and efficient. The barrel and receiver can be separated in an instant. It is available in numerous versions, including the deluxe models which continue to be made in the Custom Shop.



SA-22 GRADE II (RIGHT)



SA-22 GRADE III (RIGHT)



HI POWER 75TH ANNIVERSARY



HI POWER™ LUXUS

The Browning Hi Power is one of the greatest pistol designs of all time. A custom Hi Power offers all the engineering genius of John M. Browning embellished with the beauty and craftsmanship provided by the Browning Custom Shop. A Hi Power Luxus pistol must be held to be fully appreciated.

HI POWER RENAISSANCE SILVER



HI POWER RENAISSANCE GOLD



CUSTOM MADE IN BELGIUM

The Custom Gun Shop of Fabrique Nationale and the Herstal, Belgium Engravers' Cooperative, will make available on special order many different custom enhancements. These firearms will be fully assembled, fitted and engraved in Belgium to the personal designs and specifications of the shooting enthusiast.

PRICE

Prices for the basic firearm, before custom enhancement, are available from the sales department at Browning in Morgan, Utah by calling (801) 876-2711. All prices are subject to change due to changing world currencies.

HOW TO BUILD A CUSTOM GUN

Visit browning.com/custom to view or download the Browning Custom Shop brochure. In addition to showcasing the firearms available, this brochure displays and explains the many grades, engraving patterns, checkering patterns, stock and forearm designs and personal touches available to the customer.

HOW TO ORDER

All inquiries for Custom Gun Shop products will be submitted to headquarters in Morgan, Utah. Once the basic specifications have been determined, a written order should be placed with the Morgan office. The specifications will be reviewed with the Custom Shop in Belgium, and a price and delivery date will be determined.

DELIVERY

Actual production time will be based on the complexity and detail of the custom order. An approximate delivery date will be furnished with the factory cost quotation.



BROWNING®

BROWNING.COM/CUSTOM





SAFES

30 Years

**BROWNING PROSTEEL SAFES —
30 YEARS OF PROTECTING WHAT MATTERS TO YOU MOST.**

Browning ProSteel safes have come a long way in the past 30 years, with vastly more models, colors and interior options than ever before. We now make even better use of the interior space, with higher gun capacities and improved storage organization capabilities. One thing that hasn't changed is the quality and commitment to protect your family, guns and valuables. Browning ProSteel safes — 30 years of being The Best There Is®.



AXIS™ ADJUSTABLE SHELVING

THE MOST VERSATILE SAFE INTERIOR EVER DESIGNED. PERIOD.

Browning ProSteel safes lead the industry when it comes to managing safe interior storage. Nowhere is our expertise more evident than with our innovative Axis Adjustable Shelving (patent pending). Unlike shelves in other safes that are either fixed in position or only offer vertical adjustment, Axis shelves can be adjusted both vertically and horizontally, to accommodate items over a broad range of sizes while working around long guns. All premium Browning Pro-Steel safes feature the Axis Adjustable Shelving system. Platinum Plus and Gold Series safes come fully loaded with an all-shelf interior that can be customized to meet your needs. Additional Axis shelves can be purchased to convert your Medallion or Silver Series safe to an all-shelf interior as well (see page 120 for details). Check out a Browning ProSteel safe with Axis Adjustable Shelving and imagine the treasures you could fill one with.

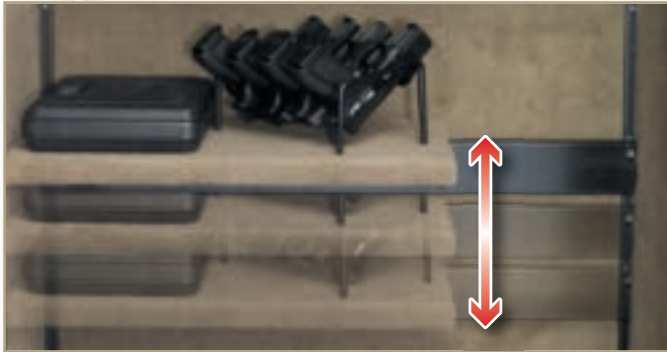

A vertical track mounted to the back of the safe interior allows the horizontal rail to be repositioned up or down along the vertical axis.

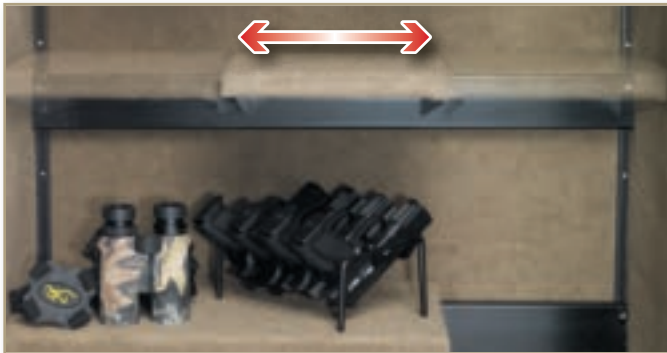

The cantilevered design of the Axis Adjustable Shelving can be placed anywhere left or right along the horizontal axis. Shelving can also be combined to make one long shelf.

From all gun to all shelves and all points in between, Axis Adjustable Shelving offers more versatility than any other safe shelving available. The possibilities are almost endless.



Arrangement Option #1



Arrangement Option #2

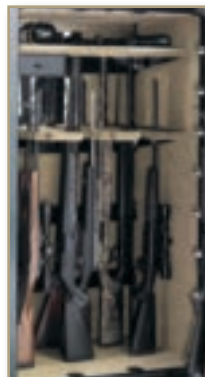

Arrangement Option #3





DPX® STORAGE SYSTEM
BETTER THAN EVER. AGAIN.

None can match the convenience, versatility or style of our patented DPX storage system (U.S. patent #7,409,790) — except us. This revolutionary system gets even better in 2012 with the New DPX Scope Saver™ (patent pending) found exclusively on Browning ProSteel safes. This new addition allows scoped rifles to be mounted on the door where they are easy to access. The Scope Saver protects scoped firearms from adjacent firearms and other contents in the safe, ensuring that time spent sighting-in isn't wasted. In addition, the space that would be taken up by a scope in a traditional safe is now freed up for another firearm. While other safes will store your guns, no other safe will protect them and keep them ready for you to use like a Browning ProSteel safe.



NEW DPX SCOPE SAVER

Found exclusively on Browning ProSteel safes, it keeps scoped rifles protected and ready for use.

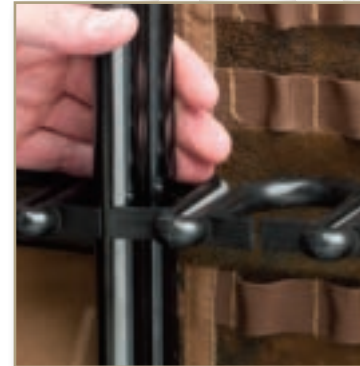

The Quick Access DPX Barrel Rack features flexible polymer wings that hold the barrel in place, yet bend to allow firearms to easily be pushed into or pulled out of the rack.



DPX Handgun Pouches allow you to store handguns on the door or in the body of the safe.

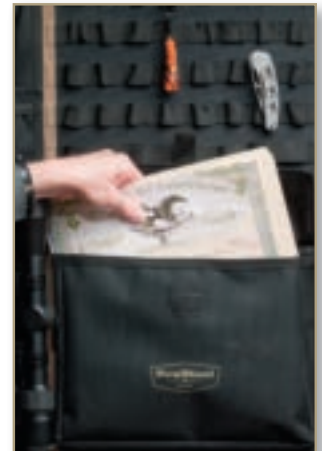

The DPX MOLLE system, along with pockets and pouches, allow for organization and storage of smaller items.

HOW MANY GUNS CAN I STORE IN MY BROWNING PROSTEEL SAFE?

The gun capacity description is a series of three numbers, for example 11/22+7. The first number is the long gun capacity of the main interior portion of the safe, with part of the space used for shelves (11 in the example). The second number is the interior long gun capacity if the shelves are removed for an all gun interior (22 in the example). The "plus" number (+7 in the example) is the long gun capacity on the back of the door. The door back capacity can be used to store long guns whether or not shelves are used in the interior. Since capacity is determined by safe size and features, each safe will have different interior capacities.

UP TO 30% MORE STORAGE THAN OTHER SAFES		
CAPACITY COMPARISON	Browning ProSteel 26 Cu. Ft. Model	Other Brand 25-28 Cu. Ft. Safe
Long Gun Capacity with Side Shelves in Place	17 guns	11-14 guns
Fast Access Guns	9 guns	2 guns
Gun Locations	Interior and door back	Interior only

All firearms, accessories and contents displayed are not included with safes.

UNI-FORCE™ LOCKING SYSTEM. TOP-LEVEL PROTECTION FROM THE NAME YOU TRUST.

Anti-pry corner bolts, rigid diversion bars and layer upon layer of hardened lock protection, all for the purpose of securing your firearms and valuables from theft. Uni-Force is found only inside our Duo-Formed® Door and provides the finest protection in the gun safe industry. This innovative design ensures rigidity, strength, security and protection. Ensure that which is yours remains yours. Lock it up with a Browning ProSteel safe.



1 UNI-FORCE™ LOCKING SYSTEM

A punch attack involves drilling through the body to access the bolts, then hammering on the bolts until the lock breaks. Our finest safe locking mechanism, the Uni-Force System, incorporates robust cam locks and a heavy-duty multiple diversion bar system to prevent bolt or handle pressure from reaching the lock. With the Uni-Force System, pounding forces go to the cams and diversion bars, not the lock, for unmatched protection against this type of attack.

2 PRY-STOP CORNER BOLTS

Extensive attack testing revealed that door corners are especially vulnerable to pry attack. Our innovative Pry-Stop Corner Bolts extend diagonally from a reinforced support at the corners of the door and add needed security to the more vulnerable corner areas.

3 LOCKING BOLT DIRECTION

Most Browning ProSteel safes have locking bolts that extend into the door frame from all four sides of the door to add extra resistance to pry attack. Safes with bolts on three sides have them on both sides of the door and on the top edge.

4 OMNIBARRIER® LOCK PROTECTION

The lock is the most important security component of a safe. It is also one of the most delicate and susceptible to drill and punch attacks. Our rugged OmniBarrier Lock Protection literally surrounds the critical lock with steel hard plate and steel components to protect it from drill, punch and push attacks.

5 DUO-FORMED® DOOR

Our finest door is built using formed layers of steel to provide superior strength, pry resistance and attack protection. A full second panel adds outstanding strength. The door face is 1 $\frac{5}{16}$ " thick.



6 REINFORCED DOOR FRAME

Browning ProSteel safes are built with a sturdy reinforced door frame that resists prying or pounding attacks. Our door frames are constructed from the same thickness of steel as the body and are bent, not welded, for superior strength, rigidity and pry resistance. Some safe manufacturers cut costs by not reinforcing the door frame, making the door opening itself a prime point for attack.

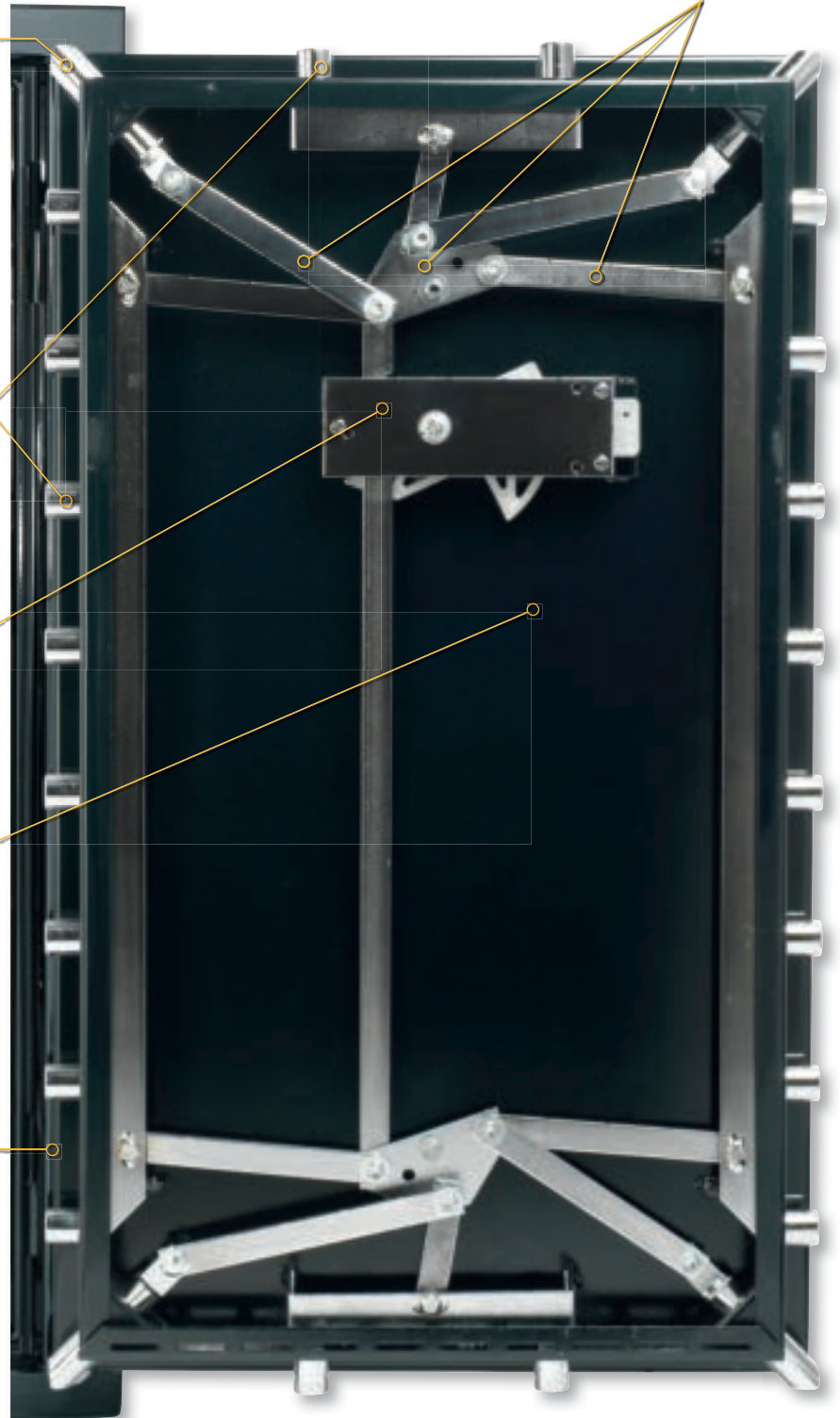

FORCE DEFLECTOR™ CLASS-LEADING SECURITY FROM PATENTED INNOVATION.

When it comes to a Browning ProSteel safe, we believe the term value should never be mistaken for compromise. Our patented Force Deflector System is a prime example of that philosophy. Force Deflector combines serious lock protection features with a rigid formed door design to offer best-in-class security and protection for all of your prized possessions.

1 FORCE DEFLECTOR™ SYSTEM

The patented, class leading Force Deflector Locking System prevents energy transfer to the lock better than many systems found on safes costing much more. This simple, yet innovative design uses a rotating cam to prevent forces on the bolt or handle from reaching the lock.

2 PRY-STOP END BOLTS

We don't cut corners; we add more protection to them. Pry-Stop End Bolts are over double the length of standard bolts and are attached to high-strength steel angle iron that prevents the locking bolt support bar from bending in a pry attack. The top and bottom locking bolts help secure the door corners.

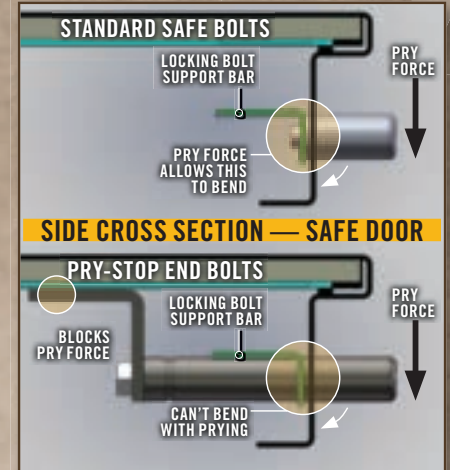
**3 LOCKING BOLTS**

When it comes to locking bolts, there is strength in size and numbers. Bigger locking bolts, and more of them, equal better security as larger diameter locking bolts are much less likely to bend than smaller bolts.

4 HARDENED STEEL PINS

Hardened steel pin lock protection is designed to combat drill attacks. Located directly in front of the locking mechanism, the smooth, hardened steel pins are extremely difficult to drill through. Unlike steel plate protection, the pins rotate freely and are more likely to bend or break drill bits.

5 RELOCKER

The Force Deflector™ Locking System includes a relocker that is triggered during an attack on the safe. The relocker secures the boltwork in the safe and prevents it from being actuated.

6 BODY STEEL THICKNESS

Body steel thickness is of utmost importance and is more critical than just being the first line of defense against drill or cut attacks. In a fire, heavier gauge steel offers better protection because it flexes less and will be less likely to crack along welds that allow heat to enter.



BROWNING PROSTEEL SAFES. WE SET THE STANDARD FOR FIRE RESISTANCE.

When comparing fire ratings on safes, the most important thing to understand is that there are no industry standards for rating the level of fire protection a safe provides. Manufacturers set their own ratings, based on their own testing methods, that can be overinflated. Test inconsistencies lead to confusing ratings that vary by manufacturer, leaving customers to decide if they trust the manufacturers' claims or not. We have provided high quality gun safes for 30 years. In that time we have learned a few things when it comes to fire protection, notably that it pays to offer honest fire ratings and gain the trust of our customers. We back up that trust with advanced fire protection features and a proven record of providing quality products. Extensive testing, industry-leading engineering and decades of experience go into every Browning ProSteel safe, resulting in best-in-class fire resistance.

WHAT MAKES A SAFE FIRE-RESISTANT?

Fire resistance is made up of several factors:

First, the amount of insulation is the most important factor. More insulation means more protection; it really is that simple.

Second, construction of the safe is hugely important. Thicker steel, fully welded gap-free body construction and reinforced door frames all reduce heat-caused flex that could open gaps in the safe and allow heat to enter. Strategic placement of insulation and external hinges means there are no gaps in fire insulation for improved protection.

Third, all Browning ProSteel safes include a Palusol® strip that expands to seal around the door frame and eliminate gaps where heat could enter. You can be confident that Browning ProSteel safes offer excellent protection for your valuables in case of fire.

OUR FIRE TESTING PROCEDURE

Our years of experience developing new safes help us understand the fire protection a safe will offer based on its construction. But that's not enough. Since the Browning name is on the line, we test every design based on a stringent test specification — our own.

To begin, we take a finished safe and place it into our on-site test furnace. We position thermocouples between the safe and the furnace walls on all four sides of the safe to record ambient temperatures of the furnace and the safe. On initial startup of the furnace, all burners are lit so the temperature inside the furnace reaches a test temperature of 1200° F within the first five minutes of the test. The temperature of the thermocouples is recorded every minute and the burners are adjusted as needed to

maintain an average temperature of 1200° F for the duration of the test. Three thermocouples are also mounted inside the safe, two just above the top shelf and the third in the middle of the safe. During testing, the internal temperature of the safe is not to rise more than 275° F. When the temperature inside the safe increases 275° F above ambient temperature, the time is recorded and the test is completed. For example, if the ambient temperature at startup is 75° F when a thermocouple inside the safe reads 350° F, the test is done. Only then is the fire rating calculated.

In contrast, some safe manufacturers will slowly ramp up to the test temperature, leaving the majority of the test at much lower temperatures than the final rating shows. Others place the thermocouples at the bottom of the safe where there is less heat. This measures the coolest air first, resulting in a higher rating claim. Worse yet, some base their fire ratings on design alone without actually testing their designs. Rest assured that the fire protection in a Browning ProSteel safe is The Best There Is®.

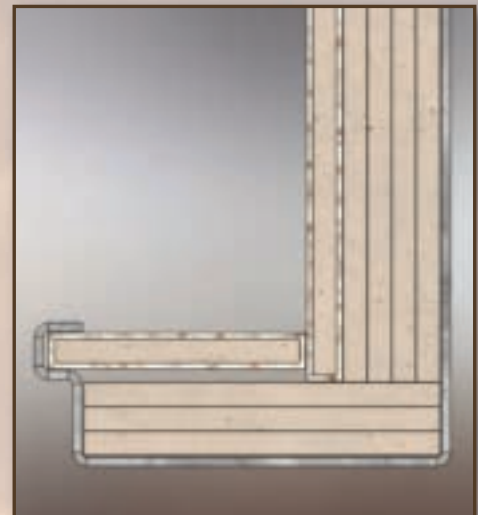
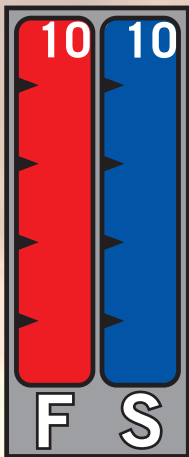

GUN SAFE WARRANTY

ProSteel offers a Gun Safe Warranty equal to the best in the industry.

Browning ProSteel safes manufactured after January 1, 2006 include a generous warranty that covers:

- **ATTEMPTED BREAK IN** • **BREAK IN** • **FIRE** •

If a safe has one of these situations and your homeowner's insurance policy does not cover the damage to the safe, ProSteel will repair or replace the safe. The contents are not covered. Shipping costs for new safe, if necessary, are included.

Some restrictions apply. See Safe Owner's Manual or browning.com for complete warranty information.

Workmanship warranty information is included.

SAFE FEATURE ICONS

The icons below highlight key features of Browning ProSteel safes, and help you quickly identify and compare the features of different safe models.



FIRE/SECURITY RATINGS

Fire and Security thermometers make it easier to compare the level of protection Browning ProSteel safes provide in these two important areas. The "F" indicates fire protection and the "S" indicates security level. Higher numbers mean better protection.

	<p>FORCE DEFLECTOR™ LOCKING SYSTEM – The Force Deflector Locking System (U.S. patent #7,665,405) prevents bolt or handle forces from reaching the lock by using a rotating cam device. It prevents energy transfer to the lock better than most systems used in the safe industry.</p>		<p>PRY-STOP CORNER BOLTS – Pry-Stop Corner Bolts provide better protection than other pry-defense designs. Innovative long locking bolts extend diagonally from a reinforced support at the corners of the door to protect against pry attack at the vulnerable corner areas.</p>
	<p>UNI-FORCE™ LOCKING SYSTEM – Our finest safe locking mechanism uses robust cam locks and a large, multiple diversion bar system to prevent bolt or handle pressure from reaching the lock. Forces go to the cams and diversion bars, not the lock, for protection unmatched by other locking systems.</p>		<p>PRY-STOP END BOLTS – Superior to other bolt designs which allow the locking bolt support bar to bend. Pry-Stop End Bolts are over 2½ times longer and attach to a high-strength steel angle iron which prevents the locking bolt support bar from bending in a pry attack. The top and bottom locking bolts on the door side secure the critical door corners.</p>
	<p>1" FORMED DOOR – The 1" Formed Door is engineered with a rugged steel face, back and reinforcement panels to provide excellent strength and attack protection compared to the competition.</p>		<p>LOCKING BOLTS (VARIABLE SIZE) – The rugged steel pieces that move behind the door frame to actually hold the safe door locked and closed. Bigger bolts, and more of them, provide greater security.</p>
	<p>DUO-FORMED® DOOR – The best safe door we offer is formed from multiple layers of steel, carefully formed together to provide superior strength, pry resistance and attack protection. Full second panel for outstanding strength. The door face is 1¾" thick.</p>		<p>BOLT DIRECTION – Better safes have locking bolts extending from all four sides of the door for extra resistance to pry attack. Safes with bolts on three sides have them on both sides of the door and on the top edge.</p>
	<p>OMNIBARRIER® LOCK PROTECTION SYSTEM – A carefully engineered structure of steel hard plate and steel components designed to protect the safe lock from drill, punch and push attacks.</p>		<p>BODY THICKNESS (VARIABLE MEASURE) – The thickness of the steel that comprises the safe body. A smaller gauge number means thicker steel, which provides more security than thinner steel. The thickest Browning ProSteel safe body is ¾" (on Platinum® Plus) and this specification is not shown in gauge measurement.</p>
	<p>FIRE RATING (VARIABLE TIME) – A laboratory measurement of time and temperature (in Fahrenheit) used to compare the relative amount of fire resistance provided by a safe. Safes with a longer fire rating time provide more fire protection than a safe with a shorter time.</p>		<p>LIGHT PACKAGE / LED – The interior light package includes two light modules to illuminate the safe interior. They make it easier for you to find items inside the safe.</p>
	<p>LAYERS OF INSULATION – The most important factor in fire protection is the total thickness of the insulation in the safe. More insulation means more protection from fire. Our safes use ½" thick gypsum panels, so the number of layers multiplied by ½" shows the total insulation thickness in inches.</p>		<p>DPH SYSTEM – The Duo-Plus Handgun Storage System (patent pending) maximizes the storage of handguns and small valuables on the door back. It has a pouch and Handgun Loop system to allow easy access to smaller items on the door back.</p>
	<p>REINFORCED DOOR FRAME – The door opening of the safe is strengthened by a U-shaped steel channel around the entire perimeter to create added pry and attack resistance.</p>		<p>DPX® SYSTEM – (U.S. patent #7,409,790) The patented Duo-Plus Extra Storage System includes a rack to store long guns on the door back. There is also a variety of pouches and pockets to store other valuables on the door back. See page 99 for a complete description.</p>
	<p>180° HEAVY DUTY HINGES – Rugged hinges are machined from solid steel bar stock for strength. The hinges allow the door to swing open 180° for unhindered access to the safe interior. Hinge-side locking bolts maintain full security even if the hinges are cut off. The door is removable to simplify moving of the safe.</p>		<p>AXIS™ – Axis Adjustable Shelving (patent pending) is the most versatile on the market. By combining multiple, moving shelves and an array of tracks, small and large items alike now fit in the safe and take up only the minimum amount of shelf space. See page 98 for a complete description.</p>
	<p>UL® SECURITY CONTAINER RATING – The industry standard test and rating for home/personal safes. Requires minimum construction specifications and passing a laboratory attack test. Our premium safes far exceed the minimum requirements for the UL Residential Security (Tool Attack) listing.</p>	<p>WHY STEP UP? Starting with the flagship Platinum Plus Series, there is a "Why Step Up?" section at the top of the description area for each series. This section is a list of just the features that distinguish that series from the series below it in the safe line up. "Why Step Up?" is an easy comparison between Browning ProSteel safe series.</p>	

THE PINNACLE OF PROTECTION

WHY STEP UP TO A PLATINUM PLUS SERIES SAFE? Massive $\frac{3}{16}$ " steel body

• 1200°F/120 min. fire protection • Grade VI interior package

ANTI-PRY FEATURES Massive $\frac{3}{16}$ " steel body • Pry-Stop Corner

Bolts at all four corners of the door • 1½" chromed locking bolts, four-sided door coverage • Uni-Force™ Locking System with Anti-Pry

• Tight-tolerance door fit • 1¾" thick Duo-Formed® Door

ADDITIONAL SECURITY FEATURES Uni-Force Locking System

• OmniBarrier® Lock Protection System • UL® tool attack listed • S & G® Group II lock with key lock dial and five-year limited warranty

INTERIOR/CONVENIENCE AND APPEARANCE FEATURES Axis™ Adjustable Shelving • Premium DPX® Storage System • Quick Access DPX Barrel Rack with New Scope Saver • Four DPX Handgun Pouches

• Integrated Jewelry Box • Knurled five-spoke Buckmark handle • Elk scene bonded to the safe door • Elevated floor makes removing guns easier • Baked-on, high-gloss finish

GRADE VI INTERIOR FEATURES Premium DPX Storage System with simulated leather trim • Quick Access DPX Barrel Rack with Scope Saver System • Interior cedar walls and ceiling • Interior light package

• Worn leather-look microfiber interior covering

FIRE PROTECTION 1200° F/120 min. fire protection • Five layers of ½" fire-resistant insulation in the body • Four layers of ½" fire-resistant insulation in the door • Premium 3-in-1 Palusol® fire seal for added fire protection

• Worn leather-look microfiber interior covering

FIRE PROTECTION 1200° F/120 min. fire protection • Five layers of ½" fire-resistant insulation in the body • Four layers of ½" fire-resistant insulation in the door • Premium 3-in-1 Palusol® fire seal for added fire protection



PLATINUM PLUS SAFE SPECIFICATIONS

MODEL	CU. FEET	DIMENSIONS (H X W X D)	WEIGHT	BOLTS	GUN CAPACITY/ INTERIOR	SUGG. RETAIL
PP65	65	72" x 56" x 28"	1,845 lbs.	28	21/53 + 13 DPX Tall	\$7,899.00
PP56	56	72" x 48" x 28"	1,715 lbs.	28	21/45 + 10 DPX Tall	7,399.00
PP47	47	72" x 40" x 28"	1,505 lbs.	28	22/33 + 10 DPX Tall	6,499.00
PP39	39	60" x 40" x 28"	1,325 lbs.	24	22/33 + 10 DPX	5,799.00

NOTE: Black Cherry and Silver Metallic finish safes feature silver/chrome handle, dial ring and graphics. The handle, dial ring and graphics for all other finish colors are gold-colored. Scenes are not available on Sand Metallic colored safes.

AVAILABLE FINISHES

Hunter Green Metallic	Gloss Black	Black Cherry	Sand Metallic	Silver Metallic Metallic
-----------------------	-------------	--------------	---------------	--------------------------

INTERIOR COLOR



GRADE VI INTERIOR

Platinum Plus Series safes feature the stunning Grade VI Interior Package. The Grade VI interior is lined with cedar paneling that creates interesting visual appeal. The shelves are lined with worn leather-look microfiber, and the DPX® system on the door back panel is trimmed in simulated leather. The Axis™ Adjustable Shelving and DPX Barrel Racks with New Scope Saver feature offer the ability to store more than ever before.



AXIS™ ADJUSTABLE SHELVING

Platinum Plus Series safes come with an Axis All-Shelf interior standard, allowing you customize your safe interior from all shelves to all guns and all points in between.

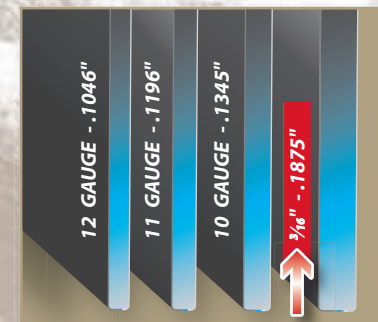

MASSIVE $\frac{3}{16}$ " STEEL BODY

$\frac{3}{16}$ " steel makes the safe heavier and tougher to move, is more time consuming to cut or drill through and flexes less when heated for better protection in a fire.

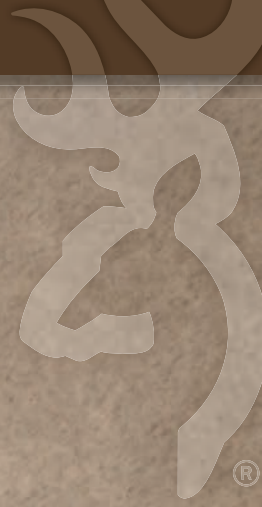

PP65
PLATINUM PLUS SERIES SAFE

COLOR SHOWN: GLOSS BLACK

**NEW DPX
SCOPE SAVER**

Found exclusively on Browning ProSteel safes, it keeps scoped rifles protected and ready for use.

NEW



PP39
PLATINUM PLUS SERIES SAFE

COLOR SHOWN: GLOSS BLACK



PP47
PLATINUM PLUS SERIES SAFE

COLOR SHOWN: BLACK CHERRY



PP56
PLATINUM PLUS SERIES SAFE

COLOR SHOWN: HUNTER GREEN METALLIC
Shown with optional Whitetail Buck/Doe scene

GOLD STANDARD OF PROTECTION

WHY STEP UP TO A GOLD SERIES SAFE?

Axis™ Adjustable Shelving • 1½" locking bolts
 • Pry-Stop Corner Bolts at all four corners of the door • 1200°F/100 min. fire protection • Interior light package • Knurled Buckmark handle
 • Integrated Jewelry Box

ANTI-PRY FEATURES Heavy 10-gauge steel body
 • Pry-Stop Corner Bolts at all four corners of the door • 1½" chromed locking bolts, four-sided door coverage • Uni-Force™ Locking System with Anti-Pry Tabs and extension arms
 • Fully reinforced integrated door frame
 • Tight-tolerance door fit • 1⅝" thick Duo-Formed® door

ADDITIONAL SECURITY FEATURES Uni-Force Locking System • OmniBarrier® Lock Protection System
 • UL® tool attack listed • S & G® Group II lock with key lock dial and five-year limited warranty

INTERIOR/CONVENIENCE AND APPEARANCE FEATURES

Innovative Axis Adjustable Shelving for more storage options • Premium DPX® Storage System
 • Quick Access DPX Barrel Rack with New Scope Saver • Four DPX Handgun Pouches • Knurled five-spoke Buckmark handle • Interior light package • Pointer scene bonded to the safe door
 • Elevated floor makes removing guns easier
 • Baked-on, high-gloss finish

FIRE PROTECTION 1200° F/100 min. fire protection

• Five layers of ½" fire-resistant insulation in the body • Four layers of ½" fire-resistant insulation in the door • Premium 3-in-1 Palusol® fire seal for added fire protection

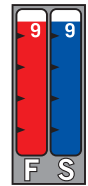

G65 | GOLD SERIES SAFE

COLOR SHOWN: SILVER METALLIC

Shown with optional Mule Deer scene

GOLD SAFE SPECIFICATIONS

MODEL	CU. FT.	DIMENSIONS (H x W x D)	WEIGHT	BOLTS	GUN CAPACITY/ INTERIOR	SUGGESTED RETAIL
G65	65	72" x 56" x 28"	1,665 lbs.	28	21/53 + 13 DPX Tall	\$6,499.00
G39	39	60" x 40" x 28"	1,165 lbs.	24	22/33 + 10 DPX	4,899.00
G28	28	60" x 30" x 27"	950 lbs.	24	11/22 + 7 DPX	3,999.00

NOTE: Black Cherry and Silver Metallic finish safes feature silver/chrome handle, dial ring and graphics. The handle, dial ring and graphics for all other finish colors are gold-colored. Scenes are not available on Sand Metallic colored safes.

AVAILABLE FINISHES



INTERIOR COLORS

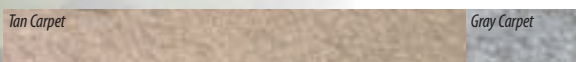



G28 | GOLD SERIES SAFE
COLOR SHOWN: BLACK CHERRY



G39 | GOLD SERIES SAFE
COLOR SHOWN: HUNTER GREEN METALLIC



Interior Light Package



Knurled Buckmark Handle



Jewelry Box



NEW DPX SCOPE SAVER

Found exclusively on Browning ProSteel safes, it keeps scoped rifles protected and ready for use.

NEW



AXIS™ ADJUSTABLE SHELVING

Gold Series safes come with an Axis All-Shelf interior standard, allowing you to customize your safe interior from all shelves to all guns and all points in between.

THE IDEAL COMBINATION OF PROTECTION AND VALUE

WHY STEP UP TO A MEDALLION SERIES SAFE? Heavy, 10-gauge steel body • OmniBarrier[®] and Uni-Force[™] Systems create a rugged, protected locking mechanism • Pry-Stop Corner Bolts on two outside corners of door • 1200° F/90 min. fire protection

ANTI-PRY FEATURES Heavy, 10-gauge steel body • Pry-Stop Corner Bolts on the two outside corners of the door • 1¼" chromed locking bolts, four-sided door coverage • Uni-Force Locking System with Anti-Pry Tabs and extension arms • Fully reinforced integrated door frame • Tight-tolerance door fit • 1⅜" thick Duo-Formed[®] Door

ADDITIONAL SECURITY FEATURES Uni-Force Locking System • OmniBarrier Lock Protection System • UL[®] tool attack listed • S & G[®] Group II lock with key lock dial and five-year limited warranty

INTERIOR/CONVENIENCE AND APPEARANCE FEATURES New Axis[™] Adjustable Shelving for more storage options • Premium DPX[®] Storage System • Quick Access DPX Barrel Rack with New Scope Saver • Four DPX Handgun Pouches • Elevated floor makes removing guns easier • Whitetail Buck/Doe scene bonded to the safe door • Baked-on, high-gloss or rugged textured charcoal finishes

FIRE PROTECTION 1200° F/90 min. fire protection • Four layers of ½" fire-resistant insulation in the body and door (five layers in the ceiling) • Palusol[®] expanding fire seal

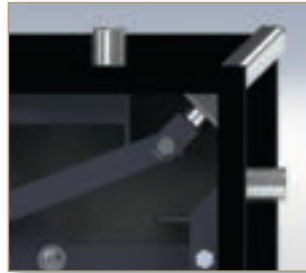

Pry-Stop Corner Bolt Mechanism protects against pry attack.

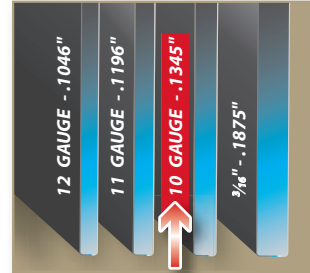

Heavy 10-gauge steel body.



Uni-Force Locking System protects against punch attack.



OmniBarrier Lock Protection System protects against drill attack.

MEDALLION SAFE SPECIFICATIONS

MODEL	CU. FT.	DIMENSIONS (H X W X D)	WEIGHT	BOLTS	GUN CAPACITY/INTERIOR	SUGGESTED RETAIL (GLOSS FINISH)	SUGGESTED RETAIL (TEXTURED FINISH)
M56	56	72" x 48" x 28"	1,365 lbs.	26	21/45 + 10 DPX Tall	\$4,899.00	\$4,599.00
M47	47	72" x 40" x 28"	1,190 lbs.	26	24/35 + 10 DPX	4,499.00	4,099.00
M39	39	60" x 40" x 28"	1,050 lbs.	18	24/35 + 10 DPX	3,999.00	3,699.00
M28	28	60" x 30" x 27"	855 lbs.	18	11/22 + 7 DPX	3,099.00	2,899.00

NOTE: Black Cherry, Silver Metallic and Textured Charcoal finish safes feature silver/chrome handle, dial ring and graphics. The handle and graphics for all other finish colors are gold-colored.

AVAILABLE FINISHES



INTERIOR COLORS

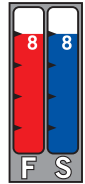



M47 | MEDALLION SERIES SAFE

COLOR SHOWN: SAND METALLIC

NEW DPX SCOPE SAVER

Found exclusively on Browning ProSteel safes, it keeps scoped rifles protected and ready for use.

NEW



AXIS™ ADJUSTABLE SHELVING

Medallion Series safes now feature the Axis Adjustable Shelving system. Additional Axis shelves can be purchased to convert your safe to an all-shelf interior. See page 120 for details.

NEW



M28 | MEDALLION SERIES SAFE

COLOR SHOWN: BLACK CHERRY

Shown with optional Mountain scene



M39 | MEDALLION SERIES SAFE

COLOR SHOWN: HUNTER GREEN

Shown with optional Painter scene



M56 | MEDALLION SERIES SAFE

COLOR SHOWN: GLOSS BLACK

Shown with optional Elk scene



HIGH END VALUE AND APPEARANCE

WHY STEP UP TO A SILVER SERIES SAFE? Axis™ Adjustable Shelving for more storage options • Strong 11-gauge steel body • 1 $\frac{5}{16}$ " thick Duo-Formed® Door with full inner plate • 1 $\frac{1}{4}$ " door bolts on all four sides for extra security • New 1200° F/75 min. fire protection • Quick Access DPX® Barrel Rack • Attractive wildlife scene available • Four DPX Handgun Pouches • Quick Access DPX Barrel Rack with New Scope Saver

ANTI-PRY FEATURES Strong 11-gauge steel body • Pry-Stop End Bolts • 1 $\frac{1}{4}$ " chromed locking bolts, four-sided door coverage • Fully reinforced integrated door frame • Tight-tolerance door fit • 1 $\frac{5}{16}$ " thick Duo-Formed door

ADDITIONAL SECURITY FEATURES Force Deflector™ locking mechanism • Hardened steel pin lock protection • UL® tool attack listed • S & G® Group II lock with key lock dial and five-year limited warranty

INTERIOR/CONVENIENCE AND APPEARANCE FEATURES Versatile Axis Adjustable Shelving for more storage options • Premium DPX® Storage System • Quick Access DPX Barrel Rack with New Scope Saver • Four DPX Handgun Pouches • Deluxe three-spoke handle • Elevated floor makes removing guns easier • Mallard scene bonded to the safe door • Baked-on, high-gloss or rugged textured charcoal finishes

FIRE PROTECTION New 1200° F/75 min. fire protection • Three layers of 1/2" fire-resistant insulation in the body and door (four layers in the ceiling and door) • Palusol® expanding fire seal

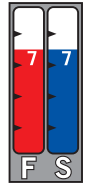

SR42 | SILVER SERIES SAFE

COLOR SHOWN: GLOSS BLACK

Shown with optional Whitetail Buck/Doe scene

SILVER SAFE SPECIFICATIONS

MODEL	CU. FT.	DIMENSIONS (H X W X D)	WEIGHT	BOLTS	GUN CAPACITY/ INTERIOR	SUGGESTED RETAIL (GLOSS FINISH)	SUGGESTED RETAIL (TEXTURED FINISH)
SR42	42	72" x 37" x 27"	960 lbs.	16/10 active	20/30 + 10 DPX Tall	\$3,399.00	\$3,099.00
SR35	35	60" x 37" x 27"	835 lbs.	16/10 active	20/30 + 10 DPX	3,099.00	2,799.00
SR26	26	60" x 30" x 25"	700 lbs.	16/10 active	10/20 + 7 DPX	2,499.00	2,299.00

NOTE: Black Cherry, Silver Metallic and Textured Charcoal finish safes feature silver/chrome handle, dial ring and graphics. The handle, dial ring and graphics for all other finish colors are gold-colored.

AVAILABLE FINISHES



INTERIOR COLORS



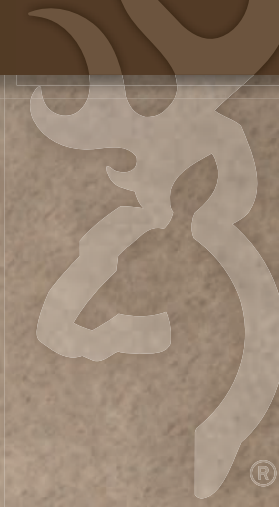

SR35 | SILVER SERIES SAFE

COLOR SHOWN: BLACK CHERRY



SR26 | SILVER SERIES SAFE

COLOR SHOWN: GLOSS BLACK

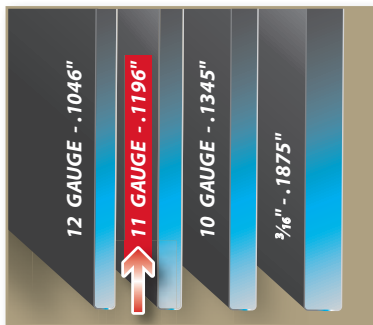

Strong 11-gauge steel body.



NEW

AXIS™ ADJUSTABLE SHELVING

Silver Series safes now feature the Axis Adjustable Shelving system. Additional Axis shelves can be purchased to convert your safe to an all-shelf interior. See page 120 for details.

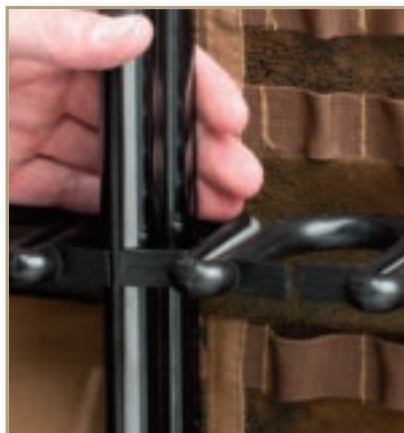

Quick Access DPX Barrel Racks

NEW

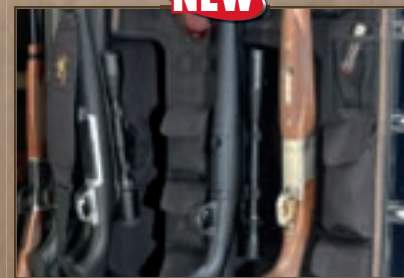

NEW DPX SCOPE SAVER

Found exclusively on Browning ProSteel safes, it keeps scoped rifles protected and ready for use.

AFFORDABLE AND LOADED WITH FEATURES

WHY STEP UP TO A BRONZE SERIES SAFE? 1200° F/60 min. fire protection

• Pry-Stop End Bolts for better pry resistance • Available in premium gloss or rugged textured charcoal finishes • Full DPX® Storage System • Two DPX Handgun Pouches

ANTI-PRY FEATURES 12-gauge steel body • Pry-Stop End Bolts • 1" chromed locking bolts, three-sided door coverage • Fully reinforced integrated door frame • Tight-tolerance door fit • 1" formed door

ADDITIONAL SECURITY FEATURES Force Deflector™ Locking System • Hardened steel pin lock protection • UL® tool attack listed • S & G® Group II lock with key lock dial and five-year limited warranty

INTERIOR/CONVENIENCE AND APPEARANCE FEATURES Full DPX Storage System • Two DPX Handgun Pouches • Deluxe three-spoke handle • Elevated floor makes removing guns easier • Scroll graphic on the door • Baked-on, high-gloss or rugged textured charcoal finishes

FIRE PROTECTION New 1200° F/60 min. fire protection • Three layers of ½" fire-resistant insulation in the body and door • Palusol® expanding fire seal



BR24 | BRONZE SERIES SAFE

COLOR SHOWN: GLOSS BLACK



BR41 | BRONZE SERIES SAFE

COLOR SHOWN: GLOSS BLACK

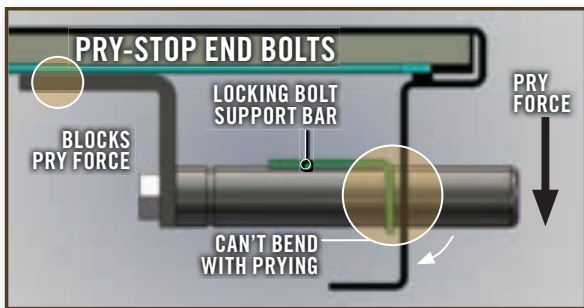
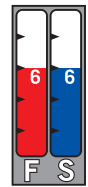

Pry-Stop End Bolt Mechanism secures door corners in a pry attack.

BRONZE SAFE SPECIFICATIONS

MODEL	CU. FT.	DIMENSIONS (H x W x D)	WEIGHT	BOLTS	GUN CAPACITY/ INTERIOR	SUGGESTED RETAIL (GLOSS FINISH)	SUGGESTED RETAIL (TEXTURED FINISH)
BR41	41	60" x 44" x 27"	875 lbs.	14/8 active	20/42 + 10 DPX	\$2,799.00	\$2,599.00
BR34	34	60" x 36" x 27"	770 lbs.	14/8 active	20/30 + 10 DPX	2,399.00	2,199.00
BR24	24	60" x 30" x 23"	585 lbs.	14/8 active	9/18 + 7 DPX	1,799.00	1,649.00
BR16	16	60" x 24" x 19"	460 lbs.	9/5 active	7/14 + 5 DPX	1,599.00	1,449.00

NOTE: Textured Charcoal finish safes feature silver/chrome handle, dial ring and graphics. The handle and graphics on Gloss Black finish safes are gold-colored.

AVAILABLE FINISHES

Gloss Black

Textured Charcoal

INTERIOR COLOR

Gray Carpet



BR34 | BRONZE SERIES SAFE

COLOR SHOWN: TEXTURED CHARCOAL



BR16 | BRONZE SERIES SAFE

COLOR SHOWN: TEXTURED CHARCOAL

compact®

SMALL IN SIZE, LOADED WITH FEATURES

A premium, scaled-down Bronzing ProSteel safe, our Compact safe is the perfect size safe for smaller valuables such as jewelry, cameras, handguns or wherever space is at a premium.

- COMPACT SERIES FEATURES** 12-gauge steel body • 1" formed steel door
- Force Deflector™ Locking Mechanism • Hardened steel pin lock protection
 - 1" chromed locking bolts • New Heavy-duty 180° external hinges • UL® tool attack listed
 - Two layers of ½" fire-resistant insulation in the body and door
 - 1200° F/45 min. fire protection • Palusol® expanding fire seal • UL Type I Electronic Lock • Baked-on high-gloss finish • Gray two-shelf interior
 - New DPH Door Storage System

COMPACT SAFE SPECIFICATIONS

MODEL	CU. FT.	DIMENSIONS (H x W x D)	WEIGHT	BOLTS	GUN CAPACITY/ INTERIOR	SUGGESTED RETAIL
H9	9	30" x 24" x 20"	275 lbs.	6/3 active	2-Shelf/Gray DPH	\$1,099.00
Interior dimensions: 27" x 21¼" x 14"						

AVAILABLE FINISH

Gloss Black

INTERIOR COLOR

Gray Carpet



H9 | COMPACT SAFE





GREAT VALUE FROM A REAL SAFE

KEY FEATURES 1200° F/45 min. fire protection

- Thick 1" formed door with three-sided locking bolts
- DPX® Storage System on top half of door back

ANTI-PRY FEATURES 12-gauge steel body • 1" chromed locking bolts, three-sided door coverage • Fully reinforced integrated door frame • Tight tolerance door fit • 1" formed door

ADDITIONAL SECURITY FEATURES Force Deflector™

- Locking System • Hardened steel pin lock protection
- UL® tool attack listed • UL Group II lock with five-year limited warranty

INTERIOR/CONVENIENCE AND APPEARANCE FEATURES

- Deluxe three-spoke handle • Elevated floor makes removing guns easier • Scroll graphic on the door
- DPX Storage System on top half of door back

FIRE PROTECTION 1200° F/45 min. fire protection • Two layers of ½" fire-resistant insulation in the body and door • Palusol® expanding fire seal

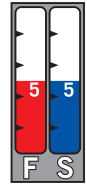

SP23 | SPORTER SERIES SAFE

COLOR SHOWN: GLOSS BLACK



AVAILABLE FINISHES



INTERIOR COLOR



SPORTER SAFE SPECIFICATIONS

MODEL	CU. FT.	DIMENSIONS (H x W x D)	WEIGHT	BOLTS	GUN CAPACITY/ INTERIOR	SUGGESTED RETAIL (GLOSS FINISH)	SUGGESTED RETAIL (TEXTURED FINISH)
NEW SP40	40	58" x 44" x 27"	760	8/5 active	22/46+10 DPX	N/A	\$2,099.00
NEW SP40 (E-Lock)	40	58" x 44" x 27"	760	8/5 active	22/46+10 DPX	N/A	2,188.00
NEW SP33	33	58" x 36" x 27"	655	8/5 active	20/30+10 DPX	\$1,999.00	1,799.00
NEW SP33 (E-Lock)	33	58" x 36" x 27"	655	8/5 active	20/30+10 DPX	2,088.00	1,888.00
NEW SP23	23	58" x 30" x 23"	515	8/5 active	9/18+7 DPX	1,399.00	1,249.00
NEW SP23 (E-Lock)	23	58" x 30" x 23"	515	8/5 active	9/18+7 DPX	1,488.00	1,338.00
NEW SP20	20	58" x 30" x 20"	490	8/5 active	8/16+7 DPX	N/A	1,149.00
NEW SP20 (E-Lock)	20	58" x 30" x 20"	490	8/5 active	8/16+7 DPX	N/A	1,238.00

NOTE: Sporter Series safes feature silver/chrome hardware and graphics.



UL® tool attack rating



SP33 | SPORTER SERIES SAFE

COLOR SHOWN: HAMMER GRAY

NEW



DPX Storage System holds more guns and allows better access.

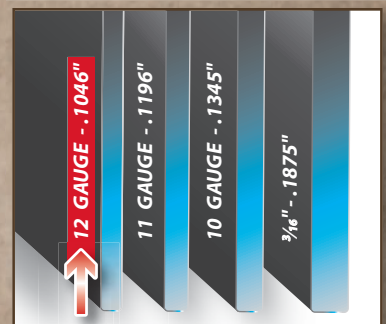

Strong 12-gauge steel body.



SP20 | SPORTER SERIES SAFE

COLOR SHOWN: HAMMER GRAY

NEW



SP40 | SPORTER SERIES SAFE

COLOR SHOWN: HAMMER GRAY
(SHOWN WITH OPTIONAL ELECTRONIC LOCK)

NEW



HARDCORE UTILITY AND STYLE

MARK II KEY FEATURES Strong 11-gauge steel body • Conveniently holds shorter guns • Interior mirror and light package make finding items easier • External Accessory Rack makes it easy to hang gear on the side of the safe

ANTI-PRY FEATURES Strong 11-gauge steel body • Pry-Stop End Bolts • 1¼" chromed locking bolts, four-sided door coverage • Fully reinforced integrated door frame • Tight-tolerance door fit • 1½" thick Duo-Formed® Door

OTHER SECURITY FEATURES Force Deflector™ Locking Mechanism • Hardened steel pin lock protection • UL® tool attack listed • S & G® Type I Electronic Lock with five-year limited warranty

INTERIOR/CONVENIENCE AND APPEARANCE FEATURES DPX® Storage System • Quick Access DPX Barrel Rack with loops for long and short barrel guns • Four DPX Handgun Pouches • Tactical-look single handle • Top Gear Loft conveniently stores gear on safe • Side Rails and External Accessory Rack for hanging items outside safe • Rubber-coated shelves • Picatinny rails make for easy mounting of accessories inside safe • Key fob holder and small item tray for even more storage versatility • Full-length mirrored back panel and interior light package • Raised-dot rubber floor panel • Elevated floor makes removing guns easier • Cast Browning name plate • Tactical Black finish

FIRE PROTECTION 1200° F/60 min. fire protection • Three layers of ½" fire-resistant insulation in the safe body and door • Palusol® expanding fire seal



AR26 | TACTICAL MARK II SERIES SAFE



AR35 | TACTICAL MARK II SERIES SAFE

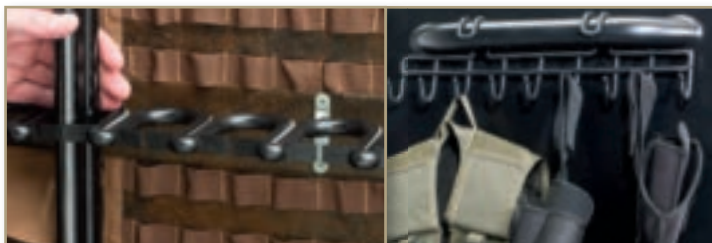

Quick Access DPX Barrel Racks

Mark II External Accessory Rack

TACTICAL MARK II SAFE SPECIFICATIONS

MODEL	CU. FT.	DIMENSIONS (H x W x D)	WEIGHT	BOLTS	GUN CAPACITY/ INTERIOR	SUGGESTED RETAIL
AR35	35	60" x 37" x 27"	875 lbs.	16/10 active	20/30 + 10 DPX	\$3,649.00
AR26	26	60" x 30" x 25"	735 lbs.	16/10 active	10/20 + 7 DPX	3,049.00

Overall dimensions of AR35 and AR26 are 6" wider than shown and 4" taller than shown due to Gear Loft and Side Rails.

AVAILABLE FINISH

Tactical Black

INTERIOR COLOR

Gray Carpet

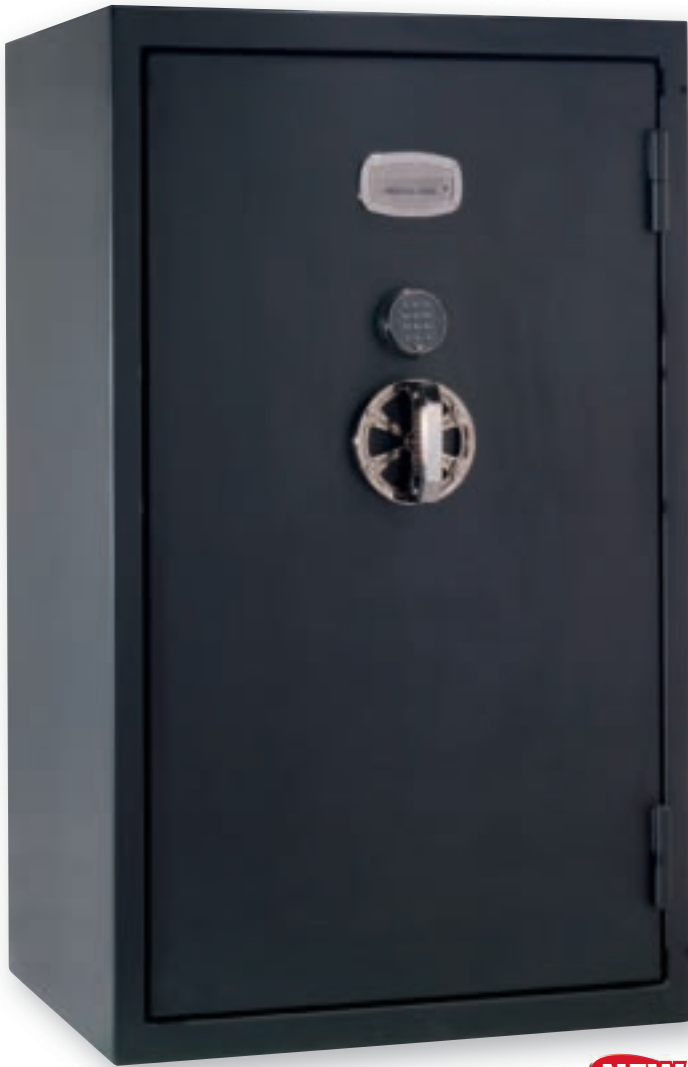

RUGGED VERSATILITY

MARK III KEY FEATURES DPX® Storage System with loops for long and short barrel guns • S & G® Type I Electronic Lock

ANTI-PRY FEATURES 12-gauge steel body • 1" chromed locking bolts, 3-sided door coverage • Fully reinforced integrated door frame • Tight-tolerance door fit • 1" Formed door

OTHER SECURITY FEATURES Force Deflector™ Locking Mechanism • Hardened steel pin lock protection • UL® tool attack listed • S & G® Type I Electronic Lock with five-year limited warranty

INTERIOR/CONVENIENCE AND APPEARANCE FEATURES DPX Storage System with loops for long and short barrel guns • Tactical-look single handle • Elevated floor makes removing guns easier • Cast Browning name plate • Tactical Black finish

FIRE PROTECTION 1200° F/45 min. fire protection • Two layers of ½" fire-resistant insulation in the safe body and door • Palusol® expanding fire seal

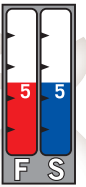

NEW

MP33 | TACTICAL MARK III SERIES SAFE



Short Guns on DPX



NEW

MP23 | TACTICAL MARK III SERIES SAFE

TACTICAL MARK III SAFE SPECIFICATIONS

MODEL	CU. FT.	DIMENSIONS (H x W x D)	WEIGHT	BOLTS	GUN CAPACITY/INTERIOR	SUGGESTED RETAIL
NEW MP33	33	58" x 36" x 27"	655 lbs.	8/5 active	20/30 + 10 DPX	\$2,499.00
NEW MP23	23	58" x 30" x 23"	515 lbs.	8/5 active	9/18 + 7 DPX	1,899.00

AVAILABLE FINISH



INTERIOR COLOR





PREFERRED DEALER EXCLUSIVE

KEY FEATURES Exclusively available from Browning Full Line and Medallion Dealers • Interior light package • Quick Access DPX® Barrel Rack • Whitetail Buck/Doe Scene or scroll graphics

ANTI-PRY FEATURES 12-gauge steel body • Pry-Stop End Bolts • 1" chromed locking bolts, three-sided door coverage • Fully reinforced integrated door frame • Tight-tolerance door fit • 1" Formed door

OTHER SECURITY FEATURES Force Deflector™ Locking Mechanism • Hardened steel pin lock protection • UL® tool attack listed • S & G® Group II lock with key lock dial and five-year limited warranty

INTERIOR/CONVENIENCE AND APPEARANCE FEATURES • DPX Storage System • Quick Access DPX Barrel Rack • Two DPX Handgun Pouches • Interior light package • Deluxe three-spoke handle • Elevated floor makes removing guns easier • Available with game scene or scroll graphic on the safe door • Baked-on, high-gloss finish

FIRE PROTECTION 1200° F/60 min. fire protection • Three layers of ½" fire-resistant insulation in the safe body and door • Palusol® expanding fire seal

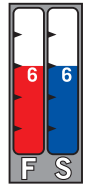

ST34 | SELECT SERIES SAFE

COLOR SHOWN: GLOSS BLACK



Select Series safes are available exclusively from Browning Full Line and Medallion Dealers.

SELECT SAFE SPECIFICATIONS

MODEL	CU. FT.	DIMENSIONS (H x W x D)	WEIGHT	BOLTS	GUN CAPACITY/ INTERIOR	SUGGESTED RETAIL
ST34	34	60" x 36" x 27"	775 lbs.	14/8 active	20/30 + 10 DPX	\$2,699.00
ST24	24	60" x 30" x 23"	590 lbs.	14/8 active	9/18 + 7 DPX	1,999.00

AVAILABLE FINISHES



INTERIOR COLOR

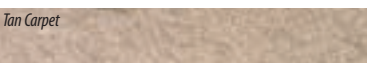

LIGHT PACKAGE

Interior lighting makes locating items inside a safe much easier. Select safes feature an integrated light package that seamlessly blends into the safe interior.



UNIVERSAL VAULT DOOR

COLOR SHOWN: HUNTER GREEN METALLIC

Shown with Whitetail Buck/Dee scene

UNIVERSAL VAULT DOOR TURN AN ENTIRE ROOM INTO A VAULT

• Designed to fit a variety of wall types and installation requirements • The minimum rough door opening for the Vault Door is 83" x 36" • External L-frame with 1/2" diameter steel J-bolt anchors (included) can be poured in place in new construction or installed in an existing door frame by using expansion anchors or lag bolts (not included)

UNIVERSAL VAULT DOOR FEATURES Door frame "L-flange" will fit any wall with a minimum thickness of 5 1/2" • 1 5/8" thick Duo-Formed® door • 22 1 1/4" chromed locking bolts • OmniBarrier® Lock Protection System • Uni-Force™ Locking System • 1 1/2" of fire-resistant insulation in the door • Knurled five-spoke Buckmark handle • External ball-bearing hinges • Palusol® expanding fire seal • UL® Listed S & G® Type I Electronic Lock • Also available with a black primer finish, allowing you to paint to match any decor • Internal lock release to open the door from within the vault

UNIVERSAL VAULT DOOR SPECIFICATIONS

MODEL	WEIGHT	BOLTS	DOOR CONSTRUCTION	SUGGESTED RETAIL (GLOSS FINISH)	SUGGESTED RETAIL (PRIMER FINISH)
Vault Door	645 lbs.	22	10-gauge/12-gauge	\$3,499.00	\$3,349.00

NOTE: Black Cherry and Silver Metallic finish safes feature silver/chrome handle, dial ring and graphics. The handle, dial ring and graphics for all other finish colors are gold-colored.

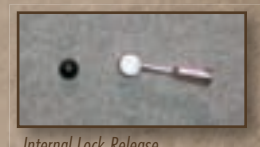

Internal Lock Release

AVAILABLE FINISHES



DIMENSIONS

The top view of a vault door.

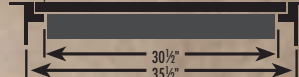

SECURITY DOOR BUILT-IN CONCEALMENT AND SECURITY

The Browning ProSteel Security Door has taken in-home security to a new level. With the appearance of a standard residential door, the Security Door is the perfect option for the consumer who prefers to be more discreet about the presence and location of valuables. The Security Door includes a UL® Listed S & G® Type I Electronic Lock with a keypad that can be mounted and concealed up to seven feet from the vault to further hide the true nature of the door. The Security Door features a six-panel door style to help blend in with other residential doors and can be painted to match. The minimum rough door opening for the Security Door is 83" x 36".

SECURITY DOOR FEATURES 1 7/8" thick Duo-Formed® type door • 1 1/4" chromed locking bolts • 1" of fire-resistant insulation in the door face • Residential interior straight brass handle • UL® Listed S & G® Type I Electronic Lock • Concealed hinges • Internal lock release to open the door from within the vault • Door swings out a full 180° when open

DIMENSIONS

The top view of a security door.

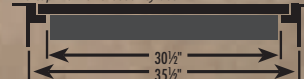

SECURITY DOOR SPECIFICATIONS

MODEL	WEIGHT	BOLTS	DOOR CONSTRUCTION	SUGGESTED RETAIL
Security Door	500 lbs.	20/10 active	12-gauge/14-gauge	\$4,199.00

AVAILABLE FINISH



SECURITY DOOR SIX-PANEL

FACTORY-INSTALLED ACCESSORIES

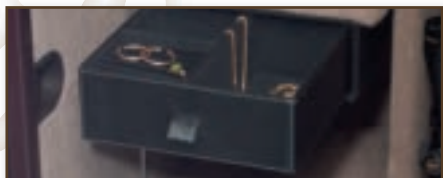

JEWELRY BOX

The Jewelry Box option makes storing and finding jewelry inside a safe much easier and convenient. The elegant Jewelry Box conveniently holds jewelry and small items inside the safe in an organized, protected manner. Exterior is synthetic leather; interior is lined with jeweler's velvet. Mounted on half shelf below gun rack on most safe models.

Optional on Gold, Medallion and Silver Series safes.

Standard on Platinum Plus Series safes.

Factory installed only.

Suggested Retail: \$69.95

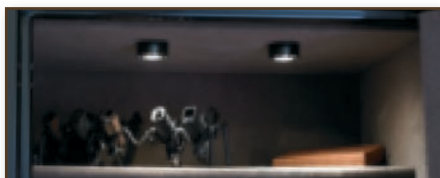

MEDALLION/SILVER SERIES LED LIGHT PACKAGE OPTION

This integrated LED lighting package makes locating objects on shelves or identifying the right firearm convenient and easy. The two included LED light modules are wired to a door-activated switch and illuminate when the door is opened. Factory installation adds a seamless look with no exposed wiring.

Optional on Medallion and Silver Series safes.

Standard on Platinum Plus and Gold Series safes.

Factory installed only.

Suggested Retail: \$129.00



FILE HANGER

The file hanger attaches easily to the side of any shelf allowing you to store documents. Can even be mounted above gun storage to take advantage of unused space. Includes one file hanger and two box-bottom hanging file folders.

Suggested Retail: \$19.95

LOCK OPTIONS

The locks below are available as factory-installed options.

Availability by series is described in the information for each lock.



S & G[®] ELECTRONIC LOCK

The S & G Electronic Lock is an advanced security system manufactured by the leader in the lock industry. Includes many technical security features.

Available on all models.

Suggested Retail: \$89.00



SECURAM BIOMETRIC LOCK

The SecuRam Biometric Lock uses the uniqueness of an individual fingerprint as the combination in this advanced security solution. The lock opens with either a fingerprint or a multi-digit code. It is highly secure and operates very quickly. Simple programming instructions. LCD Screen. Not available on Sporter, Bronze, Compact, Tactical Series safes and the Security Door.

Suggested Retail: \$279.00

INTERIOR OPTIONS



NEW

MEDALLION/SILVER SERIES ADDITIONAL AXIS™ SHELVES

Additional shelves are available for Medallion and Silver Series safes with the new Axis Adjustable Shelving. Adding shelves allows you to convert the interior of the safe to an all-shelf interior, while still maintaining long gun and small item storage on the door back thanks to the DPX Storage System. Available for Medallion and Silver Series Safes only. Set of two shelves.

Suggested Retail: \$99.95



NEW

LED SAFE LIGHTING KIT

Our New Safe Lighting Kit is the best aftermarket lighting solution available today. The expandable, linear design allows you to place long-lasting LED lighting wherever you want it in your safe. A motion sensor turns on the lights when the door opens and automatically shuts them off after 30 or 60 seconds with no motion or when the door closes. Each kit comes complete with six LED light tubes with six LEDs per tube, three flexible connectors, mounting clips with hook and loop tape, A/C adapter and a motion sensor power module.
Suggested Retail: \$69.99

USER INSTALLED ACCESSORIES

You can install all of the safe accessories shown on this page. All new Browning ProSteel safes are pre-drilled and include a molded fire-resistant electrical pass-through sleeve that accommodates the power cord for a light kit or dehumidifier.



**EVERDRY™
ELECTRIC DEHUMIDIFIER**

The EverDry Electric Dehumidifier removes humidity from the interior of a safe and protects against rust. The 18" long EverDry should be used on safes 30" wide and larger. Cord is removable for installation.
Suggested Retail: \$29.95



**FLEXIBLE EVERDRY™
ELECTRIC DEHUMIDIFIER**

The Flexible EverDry is flat and easily bends to take up less space and makes installation easier, especially in small safes. Removes humidity from the interior of a safe and protects against rust. Plug is removable for installation. LED indicates unit is operating.
Suggested Retail: \$39.95



DRY-ZONE

Absorbs moisture without electricity, and is rechargeable in an oven. It can be reactivated indefinitely. One 500-gram box protects up to 37 cubic feet of enclosed space, about the volume of a standard 30" wide safe.
Suggested Retail: \$19.95



PISTOL RACK

Store handguns more efficiently and increase storage space on shelves. Access to handguns is made easier by placing them in an upright position. 4 or 6 capacity gun models available.
Suggested Retail: \$29.95 — 6-Gun
Suggested Retail: \$19.95 — 4-Gun



DPX® HANDGUN POUCHES

Store more handguns in your safe with the versatile DPX Handgun Pouches. These versatile pouches include snap-straps to allow use on the MOLLE System used on the DPX and also hook and loop fasteners for use on carpeted interior surfaces. Set of two. Not intended for use as a belt holster.
Suggested Retail: \$29.95



ZERUST® PROTECTANT

Small capsule emits an invisible vapor that forms a corrosion- and rust-resistant barrier on metal surfaces. Volatile Corrosion Inhibitors (VCIs) have been used for years to protect metal parts in industrial and commercial applications. One capsule protects a standard 30" wide safe for one year.
Suggested Retail: \$7.99



VCI GUN SOCKS

Browning's VCI (Vapor Corrosion Inhibitor) Gun Sock seals out moisture. VCI penetrates into the smallest crevices where oils cannot reach, driving out moisture. Provides full protection by forming a vapor enclosure around firearm from muzzle to butt. The VCI Sock, when used in a safe or cabinet, will offer additional protection to all metal items in the enclosed area. One size fits most firearms.
Suggested Retail: \$16.00

HERITAGE GRAPHICS

Now it is possible to show allegiance to these great organizations that work to preserve our rights and hunting heritage. The Heritage Graphics option can be ordered to replace the game scene on many safes. You can support your favorite organization by proudly showing its logo and graphics on a gorgeous Browning ProSteel safe. We make a donation to the respective organization for each Heritage Graphics option sold. Available on all safes in the Platinum® Plus, Gold®, Medallion®, Silver® and Select Series models. (Except Sand Metallic finishes.)



HERITAGE GRAPHICS DU

COLOR SHOWN: GLOSS BLACK



HERITAGE GRAPHICS NWT

COLOR SHOWN: HUNTER GREEN

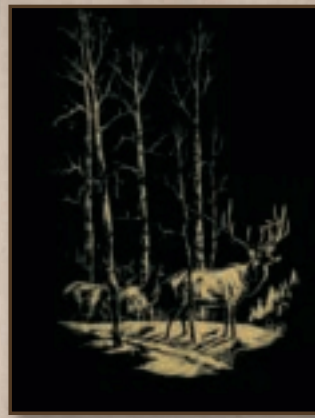

HERITAGE GRAPHICS RMEF

COLOR SHOWN: HUNTER GREEN



HERITAGE GRAPHICS NRA

COLOR SHOWN: GLOSS BLACK



GAME SCENE SELECTION AVAILABLE ON PLATINUM® PLUS, GOLD®, MEDALLION®, SILVER® AND SELECT SERIES MODELS

Each series (Platinum, Gold, etc.) has a standard metallic game scene. These scenes are permanently bonded to the door and can be applied only at the factory.



POINTER SCENE

BY LUKE FRAZIER

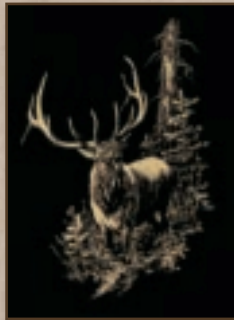

ELK SCENE

BY LEON PARSON

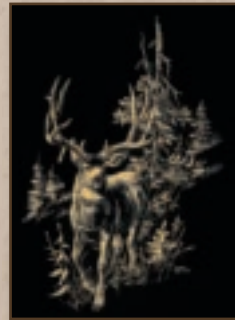

MULE DEER SCENE

BY DAVID JACKSON

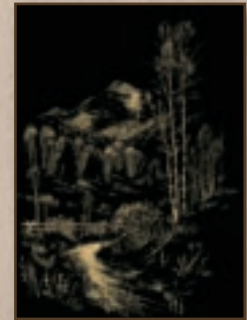

MOUNTAIN SCENE

BY DAVID JACKSON



WHITETAIL BUCK/DOE SCENE

BY LUKE FRAZIER

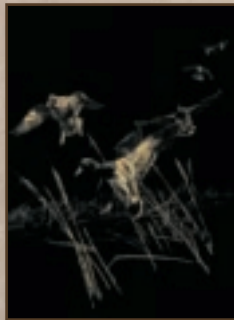

MALLARDS SCENE

BY LUKE FRAZIER

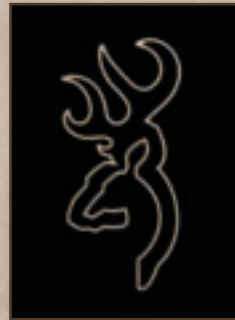

BUCKMARK SCENE

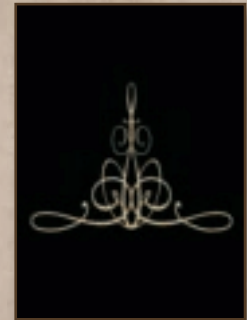





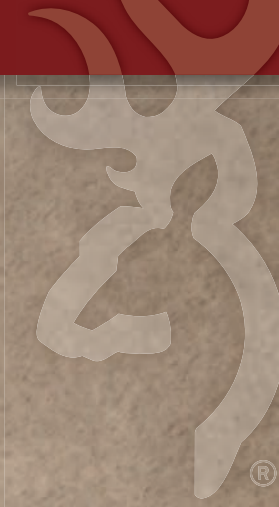

PREMIUM SAFE SCROLL

BROWNING GUN CASES FOR ALL YOUR FIREARMS.

Some of your most valuable tools need protection when transporting them. If you are proud of your guns, then move them safely and elegantly in Browning gun cases. No other manufacturer offers so many choices or provides better materials for better protection.



FITTED PRESENTATION CASE CLASSIFICATION KEY

			34"	32"+				
Stock/Receiver Capacity	Barrel Capacity	Indicates Bore and Gauge Designation	Indicates Maximum Barrel Length in Inches	Barrels Will Fit with Extended Choke Tubes Installed	Case Holds BT Style Guns	Case Holds Auto/Pump Style Guns	Case Holds Over/Under Style Guns	Rifle Case



NEW

JOHN M. BROWNING SIGNATURE LEATHER CASE

SHELL Solid wood frame • Top grain Crazy Horse distressed leather with top grain aniline dyed latigo leather trim cover • John M. Browning signature patch • Leather security straps with brass buckles **PADDING TYPE** Wool-lined interior with removable support blocks to adjust fit **HINGE** Three solid brass hinges **LATCH** Two brass combination locks **SPECIAL FEATURES** Molded thick leather full grip handle and leather corner accents • Accessory compartment with magnetized choke tube holders • Leather luggage tag • **MAGNETIC HOLDERS WILL NOT HOLD EXTENDED TITANIUM CHOKE TUBES**



John M. Browning



    32"+ 

DESCRIPTION	COLOR	DIMENSIONS	CODE #	SUGG. RETAIL
NEW John M. Browning Signature Leather Case	Crazy Horse/Brown	35¼" x 10" x 4½"	1428798208	\$640.00

CRAZY HORSE DISTRESSED LEATHER UNIVERSAL CASE

SHELL Solid wood frame covered with durable Crazy Horse distressed leather

PADDING TYPE Plush wool interior with removable support blocks to adjust fit

HINGE Full-length leather hinge

LATCH Two brass combination locks

SPECIAL FEATURES Thick leather handle and leather end caps • Accessory compartment with six choke tube slots



1 1 BT O 34"+

DESCRIPTION	COLOR	DIMENSIONS	CODE #	SUGG. RETAIL
Crazy Horse Distressed Leather Universal Case	Brown	36 $\frac{7}{8}$ " x 10 $\frac{5}{8}$ " x 4"	1424208408	\$620.00

WILD BOAR CASE

SHELL Solid wood frame • Textured synthetic pigskin • Synthetic leather trim

PADDING TYPE Soft microsuede lining with movable high-density foam support blocks

HINGE Four hidden antique brass-plated hinges

LATCH Three antique brass-plated latches

SPECIAL FEATURES Antique brass-plated corner guards • Magnetic choke tube holder compartment • **MAGNETIC HOLDERS WILL NOT HOLD EXTENDED TITANIUM CHOKE TUBES**



1 1 BT O 32"+ (Except Citori Trap or Skeet)

DESCRIPTION	COLOR	DIMENSIONS	CODE #	SUGG. RETAIL
Wild Boar Case	Sage/Brown	34" x 10 $\frac{1}{2}$ " x 3 $\frac{3}{4}$ "	1421044212	\$280.00

HIGH GRADE CANVAS/CRAZY HORSE LEATHER UNIVERSAL CASE

SHELL Solid wood frame • Canvas covered with heavy high-grade leather on borders • Handle and fastening straps

PADDING TYPE Soft wool lining

HINGE Three solid brass hinges

LATCH Two solid brass combination locks

SPECIAL FEATURES Polished brass fittings • Buckmark logo stamped on leather patches on the inside and outside • Leather trim • Accessory compartment



1 1 BT O 34"+

DESCRIPTION	COLOR	DIMENSIONS	CODE #	SUGG. RETAIL
High-Grade Canvas/Crazy Horse Leather Trim Case	Sage/Tan	36 $\frac{7}{8}$ " x 10 $\frac{5}{8}$ " x 4"	1424504408	\$420.00



Charcoal/Brown



NEW

Olive/Brown

Charcoal/Brown

LEATHER/CANVAS UNIVERSAL CASES

SHELL Solid wood frame • Canvas covered • Full-grain reinforced leather trim **PADDING TYPE** Soft wool lining with movable padded support blocks **HINGE** Three solid brass hinges **LATCH** Two brass combination locks and adjustable leather straps **SPECIAL FEATURES** Embroidered Browning logo inside lid • Buckmark logo stamped on leather patch outside

1 1 BT U 34"+

DESCRIPTION	COLOR	DIMENSIONS	CODE #	SUGG. RETAIL
Leather/Canvas Case (Except BT-100)	Charcoal/Brown	36 ³ / ₄ " x 10 ¹ / ₂ " x 4 ³ / ₄ "	1426129408	\$360.00
NEW Leather/Canvas Case (Except BT-100)	Olive/Brown	36 ³ / ₄ " x 10 ¹ / ₂ " x 4 ³ / ₄ "	1426125408	360.00



NEW

BARROW UNIVERSAL CASE

SHELL Solid wood frame • Polyester twill exterior with synthetic leather trim **PADDING TYPE** Microsuede over padded lining with movable padded support blocks **HINGE** Four antique brass hinges **LATCH** Antique brass combination locks **SPECIAL FEATURES** Magnetic choke tube holder compartment • **MAGNETIC HOLDERS WILL NOT HOLD EXTENDED TITANIUM CHOKE TUBES**

1 1 U 30"+

DESCRIPTION	COLOR	DIMENSIONS	CODE #	SUGG. RETAIL
NEW Barrow Case	Olive/Brown	32" x 10 ³ / ₄ " x 3 ³ / ₄ "	1421054012	\$200.00



NEW

SA-22 Case



NEW

Universal Over/Under Case

1 1 R 22 CAL

DESCRIPTION	COLOR	DIMENSIONS	CODE #	SUGG. RETAIL
NEW Soft Frisco, SA-22 Case	Black	30" x 12" x 4 ¹ / ₂ "	1426009290	\$185.00

FRISCO CASES

SHELL 600-denier polyester canvas exterior **PADDING TYPE** Thick foam interior with stock and barrel cutouts **SPECIAL FEATURES** Padded carry handles • Padded shoulder strap • Lightweight • Large exterior accessory pockets with zipper closures and elasticized loops • Double slider zipper closure

1 1 BT U 30"

DESCRIPTION	COLOR	DIMENSIONS	CODE #	SUGG. RETAIL
NEW Soft Frisco, Universal O/U Case	Black	35" x 12" x 4 ¹ / ₂ "	1426009408	\$200.00

RUGGED AND HANDSOME.

There is no better way to protect and transport your firearm than within a fitted gun case. These handsome cases are available in a variety of styles and feature rugged construction, water-repellent coatings, brass corner accents, deep pile fleece linings, rigid framing, secure locks and comfortable handles. Some cases even include accessory compartments for small items such as choke tubes. Most cases have moveable padded blocks that can be customized to precisely fit your gun. Show your appreciation and show off your firearm with a Browning fitted case.



AVAILABLE COLORS



AVAILABLE INTERIORS



TRADITIONAL CASES

SHELL Rugged wood construction covered with expanded vinyl
PADDING TYPE Deep pile fleece with fabric-covered positioning blocks
HINGES Three brass-plated hinges
LATCH One or two key locks
SPECIAL FEATURES Brass corner accents • Folding handle
 • Accessory compartment

DESCRIPTION	CLASSIFICATION	COLOR	DIMENSIONS	CODE #	SUGG. RETAIL
1 ▶ Traditional BT-Style Single Barrel Trap Case	1 1 BT 34" 12	Classic Brown	35½" x 8¾" x 3¾"	142810	\$290.00
Traditional BT-Style Single Barrel Trap Case (not shown)	1 1 BT 34" 12	Black/Tan	35½" x 8¾" x 3¾"	1428119410	290.00
2 ▶ Traditional Auto/Pump Shotgun Case	1 2 AP 32" 28 12 20 410	Classic Brown	35½" x 10½" x 3¾"	142821	325.00
Traditional Universal O/U, BT Trap Case (not shown)	1 1 BT 34"+ 28 12 20 410	Classic Brown	35½" x 9" x 3½"	1428118408	300.00
3 ▶ Traditional Universal O/U, BT Trap Case	1 1 BT 34"+ 28 12 20 410	Black/Tan	35½" x 9" x 3½"	1428119408	300.00
Traditional O/U Shotgun Case (Except Citori Trap or Skeet) (not shown)	1 1 32" 28 12 20 410	Classic Brown	33" x 8½" x 3"	142841	280.00
Traditional O/U Shotgun Case (Except Citori Trap or Skeet) (not shown)	1 1 30" 28 15 20 410	Classic Brown	31" x 8½" x 3"	142840	260.00
Traditional O/U Shotgun Case for Citori Trap or Skeet (not shown)	1 1 32" 28 12 20 410	Classic Brown	33¼" x 8¾" x 4½"	142880	310.00
Traditional O/U w/ Extra Barrel Case (Except Citori Trap or Skeet) (not shown)	1 2 30" 28 12 20 410	Classic Brown	31" x 10½" x 3¾"	142850	310.00
Traditional Two Gun Case (not shown)	2 2 34" 28 12 20 410	Classic Brown	36" x 8¼" x 5¾"	142890	420.00
4 ▶ Traditional Browning SA-22 Rifle Case	1 1 R 22 CALIBER	Black/Tan	27¼" x 9" x 3¼"	1428608090	300.00

CANVAS OVER/UNDER CASE

SHELL Solid wood frame covered with canvas
PADDING TYPE Soft wool lining **HINGE** Three brass hinges
LATCH Two brass combination locks
SPECIAL FEATURES Leather corner accents
 • Thick leather handle • Leather Browning logo



DESCRIPTION	COLOR	DIMENSIONS	CODE #	SUGG. RETAIL
Canvas Over/Under Case (Except Citori XS Skeet and Trap)	Olive	34 ³ / ₈ " x 9 ⁵ / ₈ " x 3 ¹¹ / ₁₆ "	142510	\$280.00



DESCRIPTION	COLOR	DIMENSIONS	CODE #	SUGG. RETAIL
Sporter Case	Black/Gold	36 ¹ / ₄ " x 11" x 3 ³ / ₄ "	1422109408	\$240.00

SPORTER CASE

SHELL Solid wood frame with PVC-coated exterior
PADDING TYPE High-density convoluted foam
HINGE Full-length leather hinge
LATCH Two combination locks
SPECIAL FEATURES Interior tie-down straps



Double Gun



Takedown



Double Pistol



Ammo Case

TALON ALUMINUM FRAME CASES

SHELL Anodized aluminum frame • Diamond pattern ABS cover over composite panels
PADDING TYPE High-density foam padding • Straps to hold firearms in place on double and takedown models
CLOSURE Combination and key locks
SPECIAL FEATURES Locking ammunition storage case • Wheels on double and takedown models • Embossed metal Buckmark plaque • Lightweight

DESCRIPTION	DIMENSIONS	WEIGHT	CODE #	SUGG. RETAIL
Double Gun	53" x 16" x 5"	17 lbs.	1460079999	\$320.00
Takedown	35 ¹ / ₂ " x 10 ¹ / ₂ " x 4"	9 lbs.	1460079512	165.00
Double Pistol	13 ¹ / ₂ " x 12" x 3 ³ / ₄ "	4.3 lbs.	1460079866	90.00
Ammo Case	15 ¹ / ₂ " x 6" x 6"	4.7 lbs.	12100798	85.00

EXCEPTIONAL PROTECTION.

Bruiser gun cases offer exceptional protection for your valuable firearms during airline travel and transportation. The high-density, double wall polyethylene construction makes this case one tough "Bruiser." For added protection, foam inserts can be extended outward to keep guns separated or pushed inward if not needed.

An O-ring sealed tongue and groove lid provides excellent weather resistance. Recessed wheels offer easy mobility. Corrosion-inhibiting Zerust® inserts are added to each case to help protect your firearms from rust. Bruiser gun cases are offered in double gun and single takedown models.



Foam inserts protect guns from each other

Zerust insert protects all metal surfaces from rust

Recessed wheels

Purge valve



Double Gun



Single Takedown

BRUISER CASES

SHELL Double wall high-density polyethylene with diamond plate texturing **PADDING TYPE** High-density foam with extendable foam insert barriers

HINGE Tough Lock™ **LATCH** Three locking points for padlocks **SPECIAL FEATURES** Rounded corners

- Recessed handles • Purge valve • Tongue and groove lid with O-ring seal • Corrosion-inhibiting Zerust® inserts • Recessed wheels • Airline approved



DESCRIPTION	INSIDE DIMENSIONS	WEIGHT	CODE #	SUGG. RETAIL
Double Gun	54" x 15" x 5"	24 lbs.	149002	\$270.00
Single Takedown	38" x 14" x 5"	16 lbs.	149001	220.00

MIRAGE CASES

SHELL Copolymer **PADDING TYPE** Double convoluted foam padding **HINGE** Piano-style hinges **LATCH** Four locking points **SPECIAL FEATURES** Single gun holds one scoped firearm • Oversize double case holds two scoped firearms

- Airline approved • Corrosion-inhibiting Zerust® inserts



Double Gun



Single Gun

DESCRIPTION	INSIDE DIMENSIONS	WEIGHT	CODE #	SUGG. RETAIL
Double Gun	53¾" x 16½" x 4½"	12 lbs.	1470021	\$85.00
Single Gun	53¾" x 12¼" x 3¾"	5 lbs.	1470022	55.00

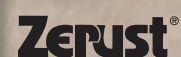



BIRCH CREEK CASES

SHELL Heavy cotton canvas **LINING** Brushed tricot
PADDING TYPE High-density open-cell foam
CLOSURE Full-length zipper with SnapTab closure allows the case to lay flat when open **MUZZLE CAP** Simulated leather
TRIM & BINDING Simulated leather • Embossed Buckmark

DESCRIPTION	SIZE	CODE #	SUGG. RETAIL
Olive Scoped	48"	1411063248	\$70.00
Olive Regular	52"	1411063152	70.00
Brown/Pink Scoped	48"	1411068248	70.00
Brown/Pink Regular	52"	1411068152	70.00



HIDALGO CASES

SHELL 600 and 1200 denier polyester canvas **LINING** Brushed tricot lining **PADDING TYPE** Open cell foam **CLOSURE** Zipper **COLOR** Black/Clay
MUZZLE CAP leather **TRIM & BINDING** Polyester nylon • Embroidered Buckmark • Side pocket with choke tube loops on 52" model
 • Shell loops on 48" model • Hook and loop closure

DESCRIPTION	SIZE	CODE #	SUGG. RETAIL
NEW Black/Clay Regular	52"	1410418152	\$45.00
NEW Black/Clay Scoped	48"	1410418248	45.00



SANTA FE CASES

SHELL Waxed 10 oz. cotton canvas **LINING** Quilted flannel
PADDING TYPE Cotton batting **CLOSURE** Zipper **COLOR** Field tan
MUZZLE CAP Leather **TRIM & BINDING** Crazy Horse leather
 • Adjustable leather strap • Side pocket with choke tube loops on 52" model, cartridge loops on 48" model • Hook and loop closure

DESCRIPTION	SIZE	CODE #	SUGG. RETAIL
Regular	52"	1419908152	\$210.00
Scoped	48"	1419908248	220.00

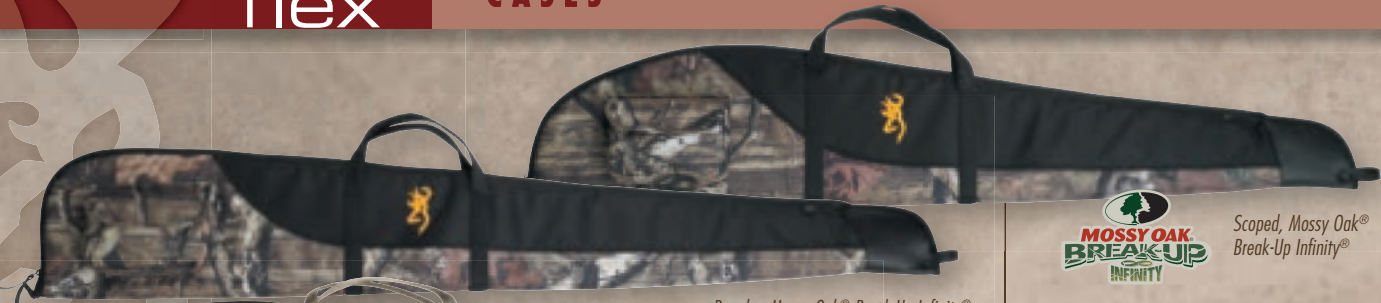

Regular, Mossy Oak® Break-Up Infinity®



Scoped, Mossy Oak® Break-Up Infinity®



Scoped



Regular

CIMMARON CASES

SHELL 600 denier polyester canvas

LINING Brushed tricot

PADDING TYPE Open-cell foam **CLOSURE** Zipper

TRIM & BINDING Polyester canvas • Outside pocket for choke tubes on 52" model, cartridge loops on 48" model

MUZZLE CAP Leather

DESCRIPTION	SIZE	CODE #	SUGG. RETAIL
MOINF Scoped	48"	1410300248	\$55.00
MOINF Regular	52"	1410300152	55.00
Scoped	40"	1410309240	45.00
Scoped	44"	1410309244	45.00
Scoped	48"	1410309248	45.00
Regular	52"	1410309152	45.00
BLR Takedown	—	1410309090	60.00



BLR Takedown



PLAINSMAN CASES

SHELL 600 denier polyester canvas

LINING Brushed tricot

PADDING TYPE Open-cell foam

CLOSURE Zipper

TRIM & BINDING Polyester canvas



Scoped, Mossy Oak® Break-Up Infinity®



Regular, Black



Slip, Realtree AP™



NEW

DESCRIPTION	SIZE	CODE #	SUGG. RETAIL	DESCRIPTION	SIZE	CODE #	SUGG. RETAIL
Black Scoped	40"	1410049240	\$32.50	NEW RTAP Regular	52"	1410043152	\$42.50
Black Scoped	44"	1410049244	32.50	NEW RTAP Slip	52"	1410043052	40.00
Black Scoped	48"	1410049248	32.50	MOINF Regular	52"	1410040152	42.50
Black Regular	52"	1410049152	32.50	MOINF Scoped	48"	1410040248	42.50
Black Slip	52"	1410049052	30.00	MOINF Scoped	50"	1410040250	54.00
NEW RTAP Scoped	48"	1410043248	42.50	MOINF Slip	52"	1410040052	40.00



TALON CASE WITH BUCKMARK

SHELL 600 denier poly canvas **LINING** Brushed tricot **PADDING TYPE** Open-and closed-cell foam **CLOSURE** Zipper **COLOR** Black
TRIM & BINDING Polyester canvas • 3D Buckmark embroidery • Oversize design fits large optics and bipods • Two zipper closure pockets

DESCRIPTION	SIZE	CODE #	SUGG. RETAIL
Black	50" Oversized	1410079250	\$60.00



Mossy Oak® Duck Blind®



Realtree Max-4®

SKIMMER ZIPPER FLOATER CASES

SHELL Polyester canvas **LINING** Nylon tricot **PADDING TYPE** High-density closed-cell foam **CLOSURE** Zipper side closure allows easy drying • Hook and loop flap **TRIM & BINDING** Side pocket

DESCRIPTION	SIZE	CODE #	SUGG. RETAIL
MODB	52"	1410522152	\$45.00
NEW RTMX4	52"	1410522452	45.00



Mossy Oak® Duck Blind®



Realtree Max-4®

BEAR RIVER FLOATER CASES

SHELL 600 denier polyester **LINING** Nylon **PADDING TYPE** Closed-cell foam **CLOSURE** Hook and loop flap **TRIM & BINDING** Polyester • Accessory side pocket

DESCRIPTION	SIZE	CODE #	SUGG. RETAIL
NEW RTMX4	52"	1410514052	\$42.00
MODB	52"	1410512152	42.00

VCI GUN SOCKS

VCI (Vapor Corrosion Inhibitor) penetrates into the smallest crevices to drive out moisture where oils cannot reach. It provides full protection by forming a vapor enclosure around the firearm from muzzle to butt. The VCI Sock, when used in a gun safe or cabinet, will offer additional protection to all metal items in the enclosed area. One size fits most firearms. Drawstring closure.

DESCRIPTION	SIZE	CODE #	SUGG. RETAIL
VCI Gun Sock	One-Piece	149985	\$16.00
VCI Gun Sock	Two-Piece	149986	16.00



VCI (Vapor Corrosion Inhibitor) Gun Sock



Two-piece VCI Gun Sock

pistol cases · bags

FLEX FOAM™ BUCK MARK® PISTOL CASE

SHELL 600 denier polyester **LINING** Soft laminated nylon tricot
PADDING TYPE Form-fitting EVA foam **CLOSURE** Zipper **COLOR** Black
TRIM & BINDING Polyester and nylon • D-rings for attaching shoulder strap (not included) **SPECIAL FEATURES** Two cavities for extra magazines • Nylon carry straps

DESCRIPTION	SIZE	CODE #	SUGG. RETAIL
Buck Mark Case	15"	1419001	\$49.95



Birch Creek Range Bag



Cimmaron Two Pistol Range Bag

TWO PISTOL RANGE BAGS

SHELL Birch Creek: Heavy cotton canvas • Cimmaron: 600 and 1200 denier polyester canvas **CLOSURE** Double-zip tops **COLOR** Birch Creek: Olive • Cimmaron: Black/Taupe **TRIM AND BINDING** Birch Creek: Simulated leather • Cimmaron: Polyester Nylon **SPECIAL FEATURES** Two padded zippered pistol pockets • Adjustable padded shoulder straps • 12 elasticized interior magazine loops • Comfortable, wide handles • 14" L x 9" H x 9" D

DESCRIPTION	CODE #	SUGG. RETAIL
Birch Creek Two Pistol Range Bag	121106849	\$60.00
NEW Cimmaron Two Pistol Range Bag	121030099	45.00



Plainsman, 13" Pistol Rug, RTAP



Cimmaron, 13" Pistol Rug, Black/Taupe



Hidalgo, 13" Pistol Rug, Brown/Black

PISTOL RUGS

SHELL 600 and 1200 denier polyester canvas **LININGS** Laminated nylon tricot **PADDING TYPE** Open cell foam, cotton batting **CLOSURES** Zipper **COLORS** Black/Clay, Tan/Brown, RTAP, MOINF **TRIM & BINDINGS** Polyester Nylon **SPECIAL FEATURES** D-rings for attaching shoulder strap and so case can be locked (not included)



Plainsman, 13" Pistol Rug, Black



Sante Fe, 11" Pistol Rug, Tan/Brown

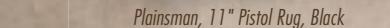

Plainsman, 11" Pistol Rug, Black

DESCRIPTION	SIZE	CODE #	SUGG. RETAIL
NEW Plainsman Pistol Rug, Black	11"	1430049811	\$18.00
Plainsman Pistol Rug, Black	13"	1430049813	18.00
NEW Plainsman Pistol Rug, RTAP	13"	1430043813	20.00
Plainsman Pistol Rug, MOINF	13"	1430040813	20.00
Cimmaron Pistol Rug, Black/Taupe	11"	143030911	18.00
Cimmaron Pistol Rug, Black/Taupe	13"	143030913	18.00
NEW Hidalgo Pistol Rug, Black	11"	1430418811	18.00
NEW Hidalgo Pistol Rug, Black	13"	1430418813	18.00
Sante Fe Pistol Rug, Tan/Brown	11"	143990811	50.00

Pistols and magazines shown are not included.

books



JOHN M. BROWNING BIOGRAPHY

The essential biography detailing the life and inventions of the greatest firearms inventor the world has ever known • Includes detailed original patent drawings and photographs • Hardcover • 390 pages

CODE #	DESCRIPTION	SUGG. RETAIL
12980	John M. Browning Biography	\$38.00

ARS MECHANICA HISTORY

The ultimate history of Fabrique Nationale, one of the world's greatest gunmakers • Illustrated with hundreds of photos, illustrations and technical drawings of FN, Browning, Winchester guns and other products, many never before published • The perfect gift for Browning collectors • Hardcover • 576 pages

CODE #	DESCRIPTION	SUGG. RETAIL
12981	Ars Mechanica Book	\$100.00



gun accessories

THE ONLY GEAR YOU'LL EVER NEED.

Dependable, quality gear is essential for a successful day at the range or in the woods. Browning has offered a comprehensive line of high-quality, innovative hunting and shooting accessories for many years and for every endeavor. Each item represents true Browning quality. The best guns deserve the best accessories.

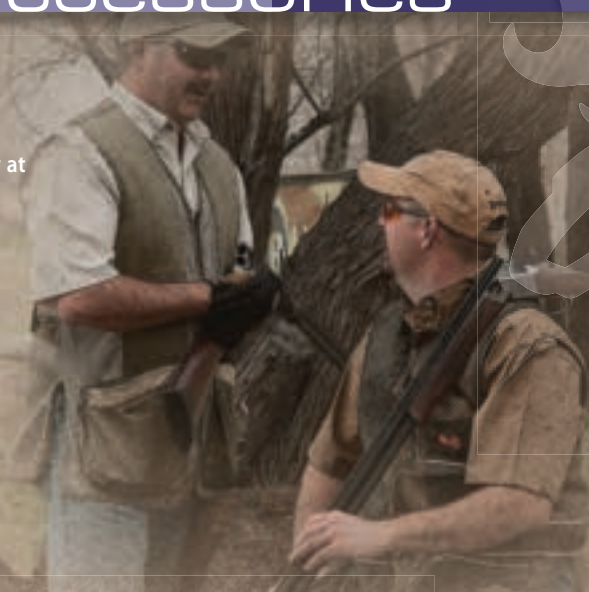

NEW



HIDALGO SINGLE BOX HOLDER

- Holds one box of shotgun shells for instant access
- Metal clip attaches to belt

NEW



HIDALGO SIX BOX HOLDER

- Accessory pockets
- Sturdy web handles

NEW



HIDALGO SHELL POUCH

- 600 and 1200 denier polyester canvas
- Large double compartment
- Adjustable belt with quick-release buckle

NEW



HIDALGO RANGE BAG

- 600 and 1200 denier polyester canvas
- Large oversized main body holds 10 shell boxes plus gear
- Five large double-zip accessory pockets
- Pop open top keeps bag open for easy access
- Comfortable padded handles and shoulder strap
- Lockable zipper closures on main compartment
- 14" W x 8" H x 11" D



DESCRIPTION	CODE #	SUGG. RETAIL
NEW Range Bag	121041891	\$65.00
NEW Shell Pouch	121041893	22.00
NEW Single Box Holder	121041894	10.50
NEW Six Box Holder	121041895	18.50

CLAYMASTER™ SERIES SHOOTING BAG

- 600 denier polyester outer • Padded interior for rigid shape • Choke tube/shell loops • Four exterior accessory pockets • Comfortable padded handles and shoulder strap • Interior divider
- 11" W x 9" H x 8" D

**CLAYMASTER™ SHELL POUCH LONG**

- 600 denier polyester outer
- Large double compartment shell pouch • Shell box holder with choke tube/shell loops • Adjustable belt with quick-release buckle

**CLAYMASTER™ EMPTY SHELL CARRIER**

- Attaches to belt • Mesh pouch

CLAYMASTER™ SHELL POUCH SHORT

- 600 denier polyester outer
- Large double compartment shell pouch • Shell box holder with choke tube/shell loops • Adjustable belt with quick-release buckle

**NEW***Shells not included with bags.***CLAYMASTER™ BOX SHELL CARRIER**

- Metal clip attaches to belt

DESCRIPTION	CODE #	SUGG. RETAIL
Shooting Bag	121020091	\$65.00
NEW Shell Pouch Short	121020092	25.00
Shell Pouch Long	121020093	27.50
Box Shell Carrier	121020094	12.00
Empty Shell Carrier	121020096	15.00

CIMMARON SHOOTING BAG

- 600 denier polyester outer • Padded interior for rigid shape • Four exterior accessory pockets • Comfortable padded handles and shoulder strap • Interior divider
- 11½" W x 10" H x 9" D

**CIMMARON FOUR BOX SHELL CARRIER**

- Accessory pockets
- Sturdy web handles

CIMMARON TWO PISTOL RANGE BAG

- 600 denier polyester canvas • Two padded pistol pockets with lockable zip closure
- Main compartment has double zip opening for easy access • Adjustable padded shoulder strap • 12 elasticized interior magazine loops

CIMMARON SHELL POUCH

- 600 denier polyester mesh pouch • Large empty hull pouch • Shell box holder with choke tube/shell loops
- Adjustable belt with quick-release buckle

**NEW****CIMMARON SHELL BOX CARRIER**

- Metal clip attaches to belt



DESCRIPTION	CODE #	SUGG. RETAIL
Shooting Bag	121030091	\$70.00
Shell Pouch	121030093	27.50
Shell Box Carrier	121030094	12.50
Four Box Carrier	121030095	18.00
NEW Two-Pistol Range Bag	121030099	45.00

Shells not included with bags.

SANTA FE SHOOTER'S BAG

- Constructed from 10 oz. waxed cotton canvas with Crazy Horse leather trim • Foam padded sides maintain bag shape • Large compartmentalized interior holds 16 boxes of shells and allows separation of shell gauges
- Sturdy YKK® zippers • Four exterior accessory pockets
- Comfortable padded leather shoulder strap and handles
- Attractive brass hardware • 12" W x 10" H x 9" D



SANTA FE SHELL POUCH

- Constructed from 10 oz. waxed cotton canvas with Crazy Horse leather trim • Large empty hull pouch • Shell box holder with choke tube/shell loops
- Adjustable belt with quick-release buckle



SANTA FE SHELL BOX CARRIER

- Constructed from 10 oz. waxed cotton canvas with Crazy Horse leather trim
- Metal clip attaches to belt

Shells not included with bags.

DESCRIPTION	CODE #	SUGG. RETAIL
Shooter's Bag	121040081	\$210.00
Shell Pouch	121040082	85.00
Shell Box Carrier	121040084	30.00

BIRCH CREEK SHELL POUCHES

- Heavy cotton canvas outer with simulated leather trim • Large divided compartment
- Three choke tube/shell loops



BIRCH CREEK COMPACT RANGE BAGS

- Heavy cotton canvas outer with simulated leather trim • Front accessory pocket • Divided interior holds eight boxes of shells
- Adjustable padded shoulder strap



BIRCH CREEK TWO PISTOL RANGE BAG

- Heavy cotton canvas with simulated leather trim • Two padded pistol pockets with lockable zip closure • Main compartment has double zip opening for easy access • Adjustable padded shoulder strap • 12 elasticized interior magazine loops



DESCRIPTION	CODE #	SUGG. RETAIL
Compact Range Bag, Olive	121106841	\$35.00
Compact Range Bag, Pink	121106511	35.00
Shell Pouch, Olive	121106843	25.00
Shell Pouch, Pink	121106513	25.00
Two-Pistol Range Bag	121106849	60.00



Mossy Oak®
Break-Up Infinity®

Digital Green

Black

Mossy Oak® New Break-Up®

Mossy Oak® Duck Blind®

Mossy Oak® Brush®

Black with
Cartridge Loops

Mossy Oak® New Break-Up®
with Cartridge Loops



Mossy Oak® Break-Up Infinity®

Digital Green

Mossy Oak® Duck Blind®

Tan

Black

Mossy Oak® New Break-Up®

Mossy Oak® Brush®

Cartridges shown are not included with slings.

X-CELLERATOR™ PLUS SLINGS

- Padded neoprene shoulder strap
- Easy adjusting, patented slip-lock buckle
- Includes metal swivels

X-CELLERATOR™ SLINGS

- Easy adjusting patented slip-lock buckle
- Can be positioned as shoulder or backpack sling • Wide range of adjustment
- 1¼" width • Includes metal swivels

DESCRIPTION	FITS	STUD DISTANCE	CODE #	SUGG. RETAIL
X-CELLERATOR PLUS SLINGS				
Mossy Oak Break-Up Infinity	Rifles	25½" to 28"	122300725	\$39.99
Digital Green	Rifles	25½" to 28"	122313425	39.99
Black	Rifles	25½" to 28"	122312025	39.99
Mossy Oak New Break-Up	Rifles	25½" to 28"	122310125	39.99
Mossy Oak Brush	Rifles	25½" to 28"	122311625	39.99
Black	Shotguns	38" to 48"	122312035	44.99
Mossy Oak New Break-Up	Shotguns	38" to 48"	122310135	44.99
Mossy Oak Duck Blind	Shotguns	38" to 48"	122313035	44.99
X-CELLERATOR PLUS SLINGS WITH CARTRIDGE LOOPS				
Black	Rifles	25½" to 28"	122302325	\$49.99
Mossy Oak New Break-Up	Rifles	25½" to 28"	122310325	49.99
X-CELLERATOR SLINGS				
Mossy Oak Break-Up Infinity	Rifles	25½" to 28"	122310725	\$29.99
Digital Green	Rifles	25½" to 28"	122303425	29.99
Black	Rifles	25½" to 28"	122302025	29.99
Tan	Rifles	25½" to 28"	122301425	29.99
Mossy Oak New Break-Up	Rifles	25½" to 28"	122300125	29.99
Mossy Oak Brush	Rifles	25½" to 28"	122301625	29.99
Black	Most Pumps and Autos	29¾" to 48¼"	122302029	29.99
Mossy Oak New Break-Up	Most Pumps and Autos	29¾" to 48¼"	122300129	34.99
Mossy Oak Duck Blind	Most Pumps and Autos	29¾" to 48¼"	122303035	34.99

ECLIPSE SLINGS

- Padded neoprene shoulder strap • Easy adjust patented buckle • Convenient thumb loop gives your arm a rest • Heavy denier polyester with neoprene padding • Select Black or Mossy Oak® New Break-Up® • Includes metal swivels



Mossy Oak® New Break-Up®

Black

DESCRIPTION	FITS	STUD DIST.	CODE #	SUGG. RETAIL
Mossy Oak New Break-Up	Rifles	25½" to 28"	122320125	\$39.99
Black	Rifles	25½" to 28"	122320025	39.99



Black



Mossy Oak®
New Break-Up®



Mossy Oak®
Duck Blind®

NEOPRENE SLINGS

- Shock-absorbing 6mm neoprene offers superior comfort • Rubberized backing is textured for a positive, non-slip grip • Ladder buckle for easy adjustment • Metal swivels

DESCRIPTION	FITS	STUD DIST.	CODE #	SUGG. RETAIL
Black	Rifles	Adjustable	12201316	\$29.99
Mossy Oak New Break-Up	Rifles	Adjustable	12201318	29.99
Mossy Oak Duck Blind	Shotguns	Adjustable	12201317	29.99

FLEX GRIP™ SLINGS

- Molded rubberized pad won't slip off shoulder and allows for stretch and comfort
- Adjustable length • Back side is textured for a positive, non-slip grip • Includes metal sling swivels • Available in black with rifle cartridge loops or brown with shotgun shell loops



Black



Brown

DESCRIPTION	FITS	STUD DIST.	CODE #	SUGG. RETAIL
Black	Most Rifles	Adjustable	1226799	\$34.99
Brown	Most Shotguns	Adjustable	1226717	34.99

FLEX FOAM™ SPORTER SLINGS

- Waterproof, extra-thick molded foam provides the ultimate in comfort • Back side is textured for a positive, non-slip grip • Available in Black, Mossy Oak® New Break-Up® or Mossy Oak® Duck Blind®
- Includes metal sling swivels



Black



Mossy Oak® New Break-Up®



Mossy Oak® Duck Blind®

DESCRIPTION	FITS	STUD DIST.	CODE #	SUGG. RETAIL
Black	Most Rifles	Adjustable	12230	\$19.99
Mossy Oak New Break-Up	Most Rifles	Adjustable	12231	24.99
Mossy Oak Duck Blind	Most Shotguns	Adjustable	12232	24.99

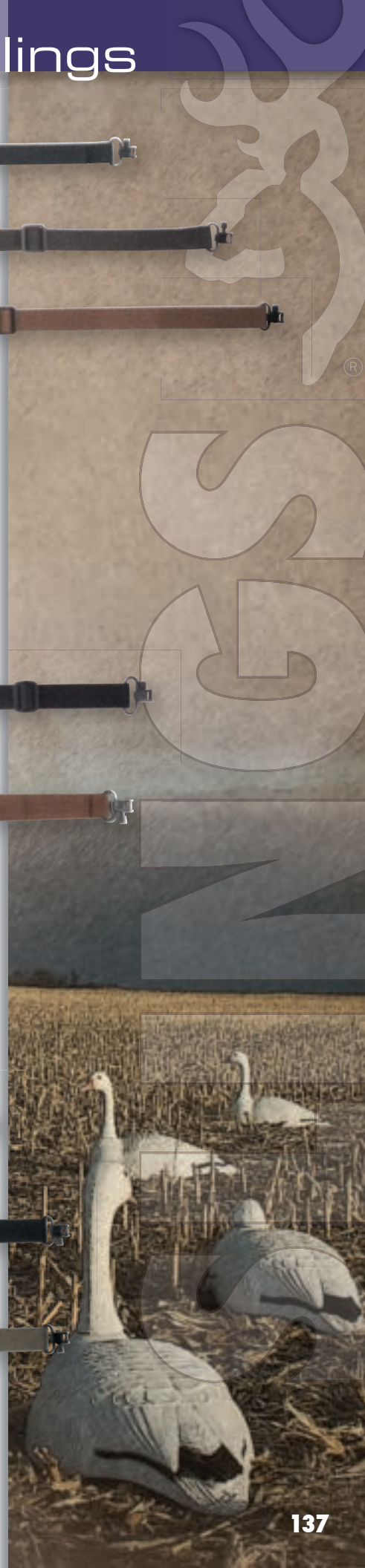

DURA-TOUCH®
Armor Coating



CONTOUR CLINCHER SLINGS

- Quiet Dura-Touch® Armor Coating improves grip in all conditions
- Has comfort contour fit
- Won't slide or roll off shoulder
- Resists cracking and fading
- Includes metal sling swivels

DESCRIPTION	FITS	STUD DIST.	CODE #	SUGG. RETAIL
Black	Rifles and Shotguns	Adjustable	122920	\$34.99
Green Camo	Rifles and Shotguns	Adjustable	12294009	34.99

Timber



Royal



Black



Driftwood

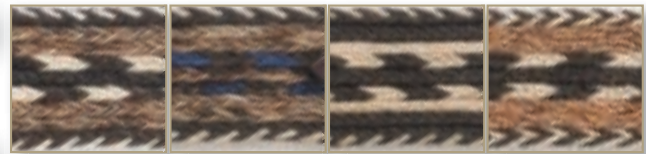

Timber

Royal

Black

Driftwood

HORSEHAIR SLINGS

- Attractive colors and patterns
- Braided horsehair is stylish, comfortable and strong
- Features all-leather reinforcement and a thumb loop
- One size fits most rifles and shotguns
- Swivels not included

DESCRIPTION	CODE #	SUGG. RETAIL
Timber	122294	\$59.99
Royal	122255	59.99
Black	122299	59.99
Driftwood	122298	59.99

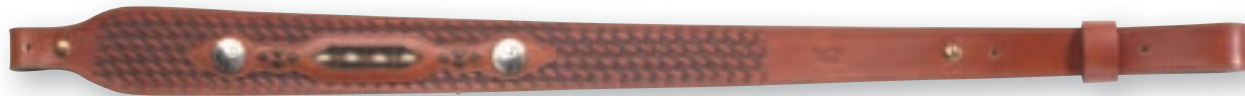

Buffalo Nickel

Southwestern



Barbed Wire



BUFFALO NICKEL SLING

- Basketweave design
- Full-grain leather construction with suede backing
- Unique buffalo nickel overlays
- Braided horsehair inlay
- Swivels not included

DESCRIPTION	CODE #	SUGG. RETAIL
Buffalo Nickel	122602	\$69.99
Southwestern	122603	69.99
Barbed Wire	122604	69.99

SOUTHWESTERN SLING

- Jacquard weave pattern in Southwestern style
- Full-grain leather construction with suede backing
- Braided horsehair inlay
- Swivels not included

BARBED WIRE SLING

- Twisted leather cord provides a barbed wire look
- Full-grain leather construction with suede backing
- Swivels not included

Santa Fe, Crazy Horse

Santa Fe, Brown, Padded

Rio Lobo

SANTA FE/RIO LOBO SLINGS

- Top-grain, silicone-treated leather is padded for comfort • **RIO LOBO** sling has three cartridge loops • Leather ties are included on **SANTA FE** (Brown) and **RIO LOBO** models
- **CRAZY HORSE** sling features distressed leather and includes metal swivels
- Swivels not included on **SANTA FE** (Brown) and **RIO LOBO** models

Cartridges shown are not included with slings.

DESCRIPTION	CODE #	SUGG. RETAIL
Santa Fe, Crazy Horse	122503	\$39.99
Santa Fe, Brown, Padded	12249	44.99
Rio Lobo	12260	49.99

Laredo Sling (with Knife and sewn-in Knife Pocket)

Laredo Plus Sling (with Removable Sheath and Knife)



Included Knife

LAREDO SLING (WITH KNIFE)

- Sling features top grain leather with white stitching and large stamped Buckmark logo
- Slip-resistant suede backing • Heavy-duty brass hardware • Knife fits into sewn-in pocket on sling • Knife features rugged black grain G-10 handle and solid brass bolsters • Razor sharp 3" drop point blade • Reliable lockback design

LAREDO PLUS SLING

(WITH REMOVABLE SHEATH AND KNIFE)

- Sling features top grain leather with western stitch design and large stamped Buckmark logo • Slip-resistant suede backing • Classic Western stitch design • Heavy-duty brass hardware
- Removable sheath fits on a sling or on a belt • Knife features rugged black grain G-10 handle and solid brass bolsters
- Razor sharp 3" drop point blade
- Reliable lockback design

DESCRIPTION	CODE #	SUGG. RETAIL
Laredo Sling (with Knife)	122560	\$44.99
Laredo Plus Sling (with Sheath and Knife)	122561	49.99

Latigo

Saddle Brown Western Stitch

NEW

Leather Shotgun Sling

Antique Basket Weave

Handler

Six Mile

LEATHER SLINGS

- **LEATHER WESTERN SLING** stitch design is sewn freehand
- **LATIGO** is a military-style sling providing greater accuracy by bracing the rifle with a tighter fit against arm and body
- **HANDLER** slings have convenient thumb loop • **SIX MILE** offers a western stitch design and fast, easy adjustment from 21" - 34"
- Metal swivels included with **LATIGO** and **SIX MILE** only
- **SHOTGUN** sling has wide pad with two shell loops and slips over barrel and stock

DESCRIPTION	CODE #	SUGG. RETAIL
Latigo Leather, Military Style (Swivels included)	12244	\$49.99
Brown Western Stitch (Leather ties included)	1225012	39.99
NEW Leather Shotgun Sling	122562	59.99
Antique Basket Weave	1225098	39.99
Handler Sling (Leather ties included)	12245	49.99
Six Mile (Swivels included)	12243	29.99

NEVER MISS A SHOT.

A stable rest is essential to making accurate rifle shots. Unfortunately, the terrain you are in dictates the quality of the rest you have at hand, and that can mean the difference between a clean hit or a miss at a once-in-a-lifetime trophy. Give yourself an edge with a set of Browning MOA Shooting Sticks. Ultra-light, ultra-strong 6061-T6 aircraft aluminum construction minimizes flex. Collapsible MOA Shooting Sticks take down into a compact bundle small enough to carry in a backpack, and internal shock cords put the sticks into action fast and keep the pole sections connected. A durable powder coat finish reduces glare. Long-wearing carbide steel tips provide positive footing. Textured rubber yoke protects your firearm, yet allows easy repositioning. You will never miss a shot with a set of MOA Shooting Sticks.



COLLAPSIBLE SHOOTING STICKS

- Easy to carry, quick to deploy • Extends to 40" length for sitting or kneeling shooting positions • Lightweight 9mm aluminum legs collapse into three segments of 14½" • Leg segments are secured by heavy-duty elastic shock cord • 1½" internal ferrule quickly guides poles together for tight, rigid fit • All-terrain gripper feet with carbide steel tips • Rubber coated yoke secures gun, but allows for easy repositioning • Textured, powder-coated poles minimize reflection

DESCRIPTION	CODE #	SUGG. RETAIL
Collapsible Bipod	129363	\$39.99
Collapsible Tripod	129364	49.99

Collapsible Bipod

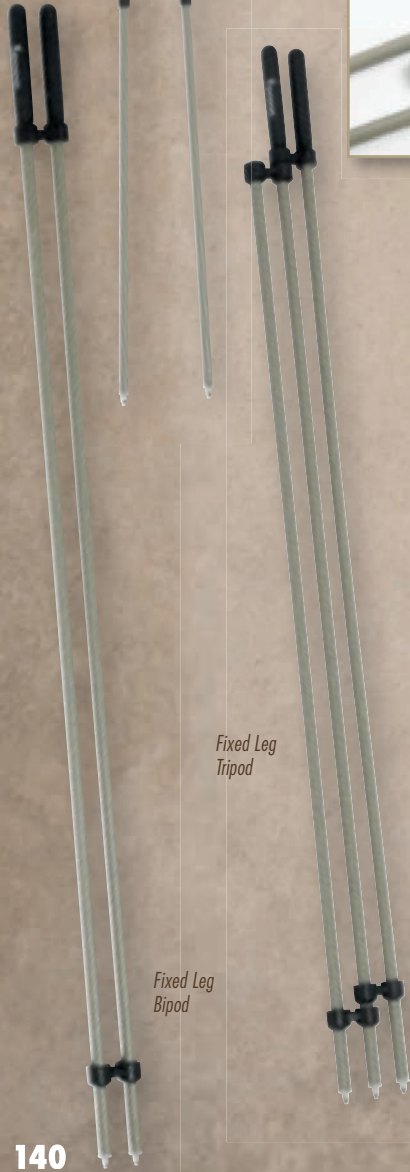

Collapsible Tripod

FIXED LEG SHOOTING STICKS

- Lightweight and easy to carry • Ultra-stable, large diameter 13mm one-piece aluminum legs • Gripper yoke secures lower legs when hiking • Approximately 40" length • All-terrain gripper feet with carbide steel tips are easily removed to add leg extensions • Rubber coated yoke secures gun, but allows for easy repositioning • Textured, powder-coated poles minimize reflection

DESCRIPTION	CODE #	SUGG. RETAIL
Fixed Leg Bipod	129360	\$39.99
Fixed Leg Tripod	129361	49.99

Fixed Leg Tripod

Fixed Leg Bipod

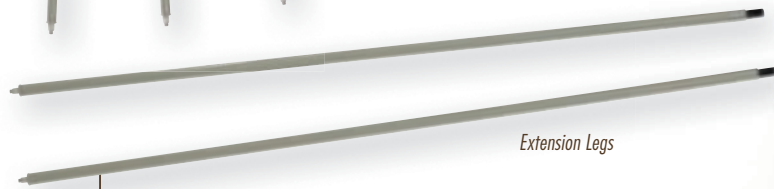

Extension Legs

EXTENSION LEGS

- Perfect for standing shots • Extension Legs raise MOA Fixed Leg Shooting Sticks approximately 29" to a comfortable 69" length • Large diameter, one-piece 13mm aluminum extensions • Easy to install • Textured, powder-coated poles minimize reflection

DESCRIPTION	CODE #	SUGG. RETAIL
Extension Legs	129362	\$14.99

GET A GOOD REST.

Wring every bit of accuracy out of your rifle and ammo with MOA Shooting Rests. These durable rests provide you with a rock-solid platform to hit the smallest targets from the bench or prone position. Polymer pellets won't absorb moisture like beanbags or sawdust filling.

MOA TWO-PIECE REST

- Ballistic nylon construction • Rubberized top and bottom hold both gun and bag in place while shooting • Polymer pellet fill allows for easy repositioning and provides a solid rest • D-ring and snap hook keep set together while storing
- Heel/toe design provides stable shooting platform



NEW



NEW



MOA WINDOW MOUNT SHOOTING REST

- Ballistic nylon construction • Rubberized top and bottom hold both gun and bag in place while shooting • Polymer pellet fill allows for easy repositioning and provides a solid rest • Polymer filled wings provide a stable position over shooting house windows or over treestand frames
- V-frame rest provides a solid platform for firearm

MOA UTILITY SHOOTING REST

- Ballistic nylon construction • Rubberized top and bottom hold both gun and bag in place while shooting
- Polymer pellet fill allows for easy repositioning and provides a solid rest • Perfect for rifles or handguns



NEW



DESCRIPTION	CODE #	SUGG. RETAIL
NEW Two-Piece Rest	129100	\$49.99
NEW Utility Rest	129101	39.99
NEW Window Rest	129103	39.99

INTEGRATED SCOPE MOUNT SYSTEM

- Integrated Scope Mounts unite the ring and base into a single, ultra-rigid unit
- Machined from 7000 series aluminum
- Eliminates alignment problems and the possibility of a loose connection between bases and rings



SCOPE BASES

- Browning Scope Bases are machined from solid steel
- Double recoil shoulder design holds rings securely, even under magnum recoil
- Compatible only with Browning Scope Rings below
- T-Bolt two-piece and SA-22 one-piece base designs are alloy and only compatible with Browning rimfire rings (Code # 12365)
- Maxus, Gold, Silver, BPS and Buck Mark bases are Weaver-type bases and are not compatible with Browning rings
- BLR Takedown bases are Weaver-type, one-piece scout-style bases for a long eye-relief scope and are not compatible with Browning rings



DESCRIPTION	FINISH	CODE #	SUGG. RETAIL
INTEGRATED SCOPE MOUNT SYSTEM (AT LEFT)			
A-Bolt Shotgun	Matte Finish	12307	\$49.99
A-Bolt Standard Height	Gloss Finish	12390	49.99
A-Bolt Standard Height	Matte Finish	12391	49.99
A-Bolt Intermediate Height	Gloss Finish	12392	49.99
A-Bolt Intermediate Height	Matte Finish	12393	49.99
A-Bolt WSSM Standard Height	Matte Finish	12380	49.99
A-Bolt WSSM Intermediate Height	Matte Finish	12381	49.99
A-Bolt Mountain Ti Standard Height	Matte Finish	12382	49.99
A-Bolt Mountain Ti Intermediate Height	Matte Finish	12349	49.99
A-Bolt Mountain Ti Standard Height	Silver Finish	12387	49.99
A-Bolt Mountain Ti Intermediate Height	Silver Finish	12388	49.99
BAR, BLR Standard Height	Gloss Finish	12394	49.99
BAR, BLR Standard Height	Matte Finish	12377	49.99
BAR, BLR Intermediate Height	Gloss Finish	12395	49.99
BAR, BLR Intermediate Height	Matte Finish	12376	49.99
T-Bolt Standard Height	Matte Finish	12338	49.99

DESCRIPTION	FINISH	CODE #	SUGG. RETAIL
SCOPE BASES (BELOW)			
A-Bolt (two-piece)	Matte Finish	12331	\$29.99
A-Bolt Mountain Ti (two-piece)	Matte Finish	12339	29.99
A-Bolt (two-piece)	High Lustre Finish	12330	29.99
BAR, BLR (two-piece)	High Lustre Finish	12332	29.99
BLR Takedown Short Action (one-piece)	Matte Finish	12327	69.99
BLR Takedown WSM/LA/Mag (one-piece)	Matte Finish	12326	69.99
BLR Takedown 450 Marlin (one-piece)	Matte Finish	12325	69.99
Maxus Gold/Silver/BPS 10 and 12 ga. (one-piece)	Matte Finish	12360	34.99
Buck Mark (one-piece)	Matte Finish	12328	34.99
T-Bolt (two-piece)	Matte Finish	12389	29.99
SA-22 (one-piece)	Matte Finish	12333	59.99

SCOPE RINGS

- Ultra-rigid vertically split rings use oversize hardware for extra strength and ease of installation
- Standard, Intermediate and High rings are available for both 1" and 30mm diameter scopes
- Compatible with the two-piece Scope Bases for A-Bolt, BAR, BLR shown above and the X-Lock bases for X-Bolt rifles shown on page 143

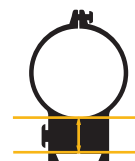

THE HEIGHT IS DETERMINED BY MEASURING FROM THE TOP OF THE BASE TO THE BOTTOM OF THE SCOPE RING.*

STANDARD (.300")

For scopes with an objective up to 44mm and a standard barrel contour

INTERMEDIATE (.400")

For scopes with an objective up to 50mm and a standard barrel contour

HIGH (.500")

For scopes with an objective up to 56mm and a standard barrel contour

* Barrel contour, optic size and preferred eye relief all affect the fit of the scope on a rifle.



DESCRIPTION	FINISH	CODE #	SUGG. RETAIL
SCOPE RINGS (AT LEFT)			
1" Standard Height — per pair	Matte Finish	12343	\$84.99
1" Intermediate Height — per pair	Matte Finish	12344	84.99
1" High Height — per pair	Matte Finish	12345	84.99
1" Standard Height — per pair	High Lustre Finish	12340	84.99
1" Intermediate Height — per pair	High Lustre Finish	12341	84.99
1" High Height — per pair	High Lustre Finish	12342	84.99
30mm Standard Height — per pair	Matte Finish	12346	84.99
30mm Intermediate Height — per pair	Matte Finish	12347	84.99
30mm High Height — per pair	Matte Finish	12348	84.99
1" Rimfire Standard Height — per pair	Matte Finish	12365	49.99



SOLID X-LOCK™ MOUNTS

Securely mounted optics are essential to the accuracy and precision of any rifle. To ensure the X-Bolt™ has the most stable mount possible, it features the X-Lock scope mounting system that uses four screws per base, replacing the traditional two-screw standard. The scope bases are then secured at all four corners rather than only held at the center of the base, offering more accurate placement of the bases on the receiver. The revolutionary X-Lock system holds the base tighter to the rifle than any other system.

Browning X-Lock Integrated Mounting System



Browning X-Lock Bases



X-LOCK™ MOUNTING SYSTEM SCOPE RINGS AND BASES FOR X-BOLT™ RIFLES

- Integrated Scope Mounts unitize the ring and base into a single unit
- Machined from 7000 series aluminum
- Eliminates alignment problems and loose connections between bases and rings
- Choose from integrated mounts in Standard, Intermediate and High rings
- Will accommodate both 1" and 30mm diameter scopes in gloss, matte and nickel finishes
- X-Lock bases are machined from solid steel, and mount with four base screws per base at each corner, offering more accurate placement of the base on the receiver (See page 142)

DESCRIPTION	FINISH	CODE #	SUGG. RETAIL
X-LOCK INTEGRATED 1" MOUNTS			
Matte Standard Integrated	Matte Finish	12501	\$59.99
Matte Intermediate Integrated	Matte Finish	12502	59.99
Matte High Integrated	Matte Finish	12503	59.99
Gloss Standard Integrated	Gloss Finish	12504	59.99
Gloss Intermediate Integrated	Gloss Finish	12505	59.99
Gloss High Integrated	Gloss Finish	12506	59.99
Nickel Standard Integrated	Nickel Finish	12507	59.99
Nickel Intermediate Integrated	Nickel Finish	12508	59.99
Nickel High Integrated	Nickel Finish	12509	59.99
X-LOCK INTEGRATED 30mm MOUNTS			
Matte Standard Integrated, 30mm	Matte Finish	12510	\$59.99
Matte Intermediate Integrated, 30mm	Matte Finish	12511	59.99
Matte High Integrated, 30mm	Matte Finish	12512	59.99
Gloss Standard Integrated, 30mm	Gloss Finish	12513	59.99
Gloss Intermediate Integrated, 30mm	Gloss Finish	12514	59.99
Gloss High Integrated, 30mm	Gloss Finish	12515	59.99
Nickel Standard Integrated, 30mm	Nickel Finish	12516	59.99
Nickel Intermediate Integrated, 30mm	Nickel Finish	12517	59.99
Nickel High Integrated, 30mm	Nickel Finish	12518	59.99
X-LOCK BASES (A LIST OF COMPATIBLE SCOPE RINGS CAN BE FOUND ON PAGE 142)			
Matte, Base	Matte Finish	12334	\$39.99
Gloss, Base	Gloss Finish	12362	39.99

X-BOLT™ EXTRA MAGAZINES

The X-Bolt uses a detachable rotary magazine constructed from a durable lightweight polymer. The magazine is designed to feed cartridges directly in line with the bolt, instead of offset as with traditional leaf-spring magazines, for a straight path right into the chamber. An ergonomic magazine-mounted release lets the magazine rotate directly downward and into the hand. The magazine sits flush with the bottom of the rifle for a sleeker appearance. Additional magazines can be kept loaded and carried in your pocket or pack for easy, safe access.

DESCRIPTION	CODE #	SUGG. RETAIL
Long Action Magnum: 338 Win. Mag., 300 Win. Mag., 7mm Rem. Mag.	112044601	\$49.99
Long Action Standard: 30-06 Sprg., 280 Rem., 270 Win., 25-06 Rem.	112044602	49.99
Short Action Magnum: 325 WSM, 300 WSM, 7mm WSM, 270 WSM	112044603	49.99
Short Action Standard: 308 Win., 7mm-08 Rem., 243 Win.	112044604	49.99
Super Short Action Standard: 223 Rem.	112044008	49.99
Super Short Action Standard: 22-250 Rem.	112044009	49.99
Large Magnum: 375 H&H Magnum	112044606	49.99



BALLISTIC OPTIMIZING SHOOTING SYSTEM

BOSS®-CR ACCESSORY



The BOSS-CR accessory offers all the accuracy and tunable advantages of the original BOSS device without the muzzle brake feature. By simply replacing the original BOSS forward weight and recoil reduction components with the one-piece, no-hole BOSS-CR accessory, only the reduced recoil of the original BOSS is sacrificed. The BOSS-CR accessory is designed to fit only BAR Mark II and A-Bolt centerfire rifles previously factory-fitted with the BOSS.

GLOSS	MATTE	STAINLESS
BAR SAFARI AND THE FOLLOWING A-BOLT MODELS: MEDALLION GOLD MEDALLION	A-BOLT MODELS: COMPOSITE STALKER HUNTER EURO-BOLT VARMINT ECLIPSE HUNTER M-1000 ECLIPSE	A-BOLT MODELS: STAINLESS STALKER WHITE GOLD MEDALLION M-1000 ECLIPSE



CALIBER	CODE #	CODE #	CODE #
223 Rem.	1140011	1140012	1140013
223 Varmint	1140061	1140062	—
223 WSSM	1140011	1140012	1140013
243 WSSM	1140011	1140012	1140013
25 WSSM	1140011	1140012	1140013
22-250 Rem.	1140011	1140012	1140013
22-250 Varmint	1140061	1140062	—
22-250 Varmint (M-1000)	—	1140062	1140063
243 Win.	1140011	1140012	1140013
7mm-08 Rem.	1140011	1140012	1140013
308 Win.	1140021	1140022	1140023
308 Varmint	1140061	1140062	—
308 Varmint (M-1000)	—	1140062	1140063
25-06 Rem.	1140011	1140012	1140013
260 Rem.	1140011	1140012	1140013
270 WSM	1140021	1140022	1140023
270 Win.	1140011	1140012	1140013
280 Rem.	1140011	1140012	1140013
30-06 Sprg.	1140031	1140032	1140033
7mm WSM	1140021	1140022	1140023
7mm Rem. Mag.	1140021	1140022	1140023
300 WSM	1140041	1140042	1140043
300 WSM (M-1000)	—	1140092	1140093
300 Win. Mag.	1140041	1140042	1140043
300 Win. Mag. (M-1000)	—	1140092	—
325 WSM	1140051	1140052	1140053
338 Win. Mag.	1140051	1140052	1140053
375 H&H Mag.	1140071	—	1140073

It is important that the correct BOSS-CR be selected for a specific caliber and model of rifle.

MODEL	SUGG. RETAIL
BOSS-CR, matte blue	\$39.99
BOSS-CR, gloss blue	39.99
BOSS-CR, stainless	39.99

A-BOLT® EXTRA MAGAZINES

CALIBER	CODE #	SUGG. RETAIL
ALL RIFLE MODELS EXCEPT MICRO HUNTER		
222 Rem.	112022007	\$79.99
204 Ruger	112022066	79.99
22-250 Rem.	112022009	79.99
223 Rem.	112022008	79.99
223 WSSM	112022044	79.99
223 Rem. SSA	112022060	79.99
243 Win.	112022011	79.99
243 WSSM	112022045	79.99
270 WSM	112022035	79.99
7mm-08 Rem.	112022016	79.99
7mm WSM	112022036	79.99
308 Win.	112022018	79.99
300 WSM	112022034	79.99
25 WSSM	112022049	79.99
25-06 Rem.	112022023	79.99
270 Win.	112022024	79.99
280 Rem.	112022025	79.99
30-06 Sprg.	112022026	79.99
7mm Rem. Mag.	112022027	79.99
300 Win. Mag.	112022029	79.99
300 Ultra Mag.	112022030	79.99
325 WSM	112022065	79.99
338 Win. Mag.	112022031	79.99
375 H&H Mag.	112022032	79.99
338 Ultra Mag.	112022038	79.99
MICRO HUNTER RIFLE		
22 Hornet	112023006	\$79.99
22-250 Rem.	112023009	79.99
243 Win.	112023011	79.99
270 WSM	112023041	79.99
7mm WSM	112023042	79.99
7mm-08 Rem.	112023016	79.99
308 Win.	112023018	79.99
300 WSM	112023040	79.99
325 WSM	11202304	79.99
A-BOLT SHOTGUN		
12 Gauge	112022001	\$79.99

NOTE: Magazines that are not listed above may be available only through the Browning Parts Department at (800) 322-4626. Cartridges shown not included.



EXTRA MAGAZINES

It makes good sense to always carry an extra magazine or two in your pocket or pack for fast reloading.

BLR® EXTRA MAGAZINES

CALIBER	CODE #	SUGG. RETAIL
SHORT ACTION CALIBERS		
223 Rem.	112026008	\$79.99
243 Win.	112026011	79.99
308 Win.	112026012	79.99
22-250 Rem.	112026009	79.99
7mm-08 Rem.	112026016	79.99
270 WSM	112026030	79.99
300 WSM	112026041	79.99
7mm WSM	112026031	79.99
LONG ACTION CALIBERS		
270 Win.	112026024	\$79.99
30-06 Sprg.	112026026	79.99
7mm Rem. Mag.	112026027	79.99
300 Win. Mag.	112026029	79.99
325 WSM	112022067	79.99
358 Win.	112026042	79.99
450 Marlin	112026043	79.99



BAR® EXTRA MAGAZINES

CALIBER	CODE #	SUGG. RETAIL
MARK II AND LIGHTWEIGHT STALKER		
243 Win. and 308 Win.	112025011	\$69.99
270 WSM	112025041	69.99
7mm WSM	112025042	69.99
300 WSM	112025030	69.99
LONGTRAC, MARK II, SAFARI AND LIGHTWEIGHT STALKER		
270 Win., 25-06 Rem., 30-06 Sprg.	112025024	\$69.99
300 Win. Mag.	112025029	69.99
338 Win. Mag.	112025031	69.99
7mm Rem. Mag.	112025027	69.99
SHORTTRAC		
243 Win. and 308 Win.	112025050	\$69.99
7mm-08 Rem.	112025051	69.99
270 WSM	112025055	69.99
7mm WSM	112025055	69.99
300 WSM	112025055	69.99
325 WSM	112025052	69.99

DOUBLE HELIX® MAGAZINES FOR T-BOLT™ RIFLES

CALIBER	CODE #	SUGG. RETAIL
22 L.R.	112055290	\$49.99
17 HMR/22 WMR	112055291	49.99



Patent pending Double Helix® rotary box magazine • Torsion spring driven interlocking gears provide added reliability plus easy loading and unloading • 10-round capacity



22 Long Rifle

17 HMR/22 WMR

HI POWER EXTRA MAGAZINES

CALIBER	CODE #	SUGG. RETAIL	CALIBER	CODE #	SUGG. RETAIL
HI POWER (10-SHOT CAPACITY)			HI POWER (13-SHOT CAPACITY)		
9mm, S.A., H.P., Standard	112050193	\$59.99	9mm, S.A., H.P., Standard	112050293	\$69.99
9mm, S.A., H.P., Pachmayr	112051193	59.99	9mm, S.A., H.P., Pachmayr	112051293	69.99
40 S&W, S.A., H.P., Standard	112050194	59.99			
40 S&W, S.A., H.P., Pachmayr	112051194	59.99			



Buck Mark Magazine



Buck Mark Magazine



Hi Power Magazine



1911-22 Magazine

BUCK MARK® EXTRA MAGAZINES

CALIBER	CODE #	SUGG. RETAIL
22 L.R.	112055190	\$29.99

1911-22 EXTRA MAGAZINES

CALIBER	CODE #	SUGG. RETAIL
22 L.R.	112055191	\$39.99

Cartridges shown not included.

Magazine Pouch



BUCK MARK® PISTOL HOLSTERS

- Tough ballistic nylon construction with molded polymer frame
- Fits most Buck Mark pistols
- Oversized model will accommodate a small scope or reflex sight
- Magazine Pouch model keeps a magazine handy
- Belt loop
- Rubberized Buckmark logo

DESCRIPTION	CODE #	SUGG. RETAIL
Buck Mark Holster w/ Magazine Pouch	12902012	\$24.99
Buck Mark Holster	12902010	19.99
Oversized Buck Mark Holster (fits small optics)	12902011	19.99

Buck Mark Pistol Holster with Magazine Pouch

Buck Mark Pistol Holster

Oversized Buck Mark Pistol Holster



1911-22 Pistol Holster with Magazine Pouch



NEW

1911-22 Leather Pistol Holster

1911 22

1911-22 HOLSTERS

- Tough ballistic nylon construction with molded polymer frame
- Fits 1911-22 pistols
- Magazine pouch
- Belt loop
- Rubberized Buckmark logo
- Leather model is styled like original military flap holster

DESCRIPTION	CODE #	SUGG. RETAIL
1911-22 Holster	12903012	\$24.99
NEW 1911-22 Leather Holster	1296522	49.99

Pistols and magazines shown are not included.

Pistols and magazines shown are not included.



FLEX FOAM™ BUCK MARK® PISTOL CASE

- Carry case fits Buck Mark pistol and two magazines • 600 denier polyester shell • Soft laminated nylon tricot lining • Nylon carry straps • Form-fitting EVA foam secures the contents • Sturdy zipper closure • D-ring

DESCRIPTION	SIZE	CODE #	SUGG. RETAIL
Pistol Case	15"	1419001	\$49.95

1911  **22**

FLEX FOAM™ 1911-22 PISTOL CASE

- Carry case fits 1911-22 pistol and one magazine • 600 denier polyester shell • Soft laminated nylon tricot lining • Nylon carry straps • Form-fitting EVA foam secures the contents • Sturdy zipper closure • D-ring

DESCRIPTION	SIZE	CODE #	SUGG. RETAIL
Pistol Case	11"	12903031	\$39.99



1911-22/BUCK MARK® PISTOL RUG

- Fits both 1911-22 and Buck Mark pistols (up to a 5½" barrel)
- Tough ballistic nylon construction • Outer pocket secures three spare magazines • Padded to protect pistol • D-ring

DESCRIPTION	CODE #	SUGG. RETAIL
1911-22/Buck Mark Pistol Rug	12902030	\$24.99





Magazine and ammunition shown are not included.

1911-22/BUCK MARK® MAGAZINE HOLDER

- Tough ballistic nylon construction
- Carries one magazine for 1911-22 or Buck Mark Rifle or pistol • Larger pocket holds extra 22 cartridges • Hook and loop closures • Belt loops

DESCRIPTION	CODE #	SUGG. RETAIL
1911-22/Buck Mark Magazine Holder	12902021	\$19.99



BUCK MARK® REFLEX SIGHT

- Four reticle patterns: Circle-Dot-Cross Reticle, 3 MOA Dot Reticle, Cross-Dot Reticle, Circle-Dot Reticle • Seven-position brightness rheostat
- Field-of-view: 15.7m/100m • Unlimited eye relief
- Powered by one #2032 lithium battery • Mounts to a standard Weaver-style base • Rugged aluminum housing with matte black finish



Circle - Dot - Cross

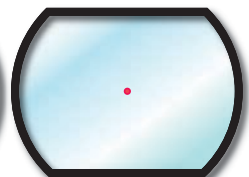

3 MOA Dot



Cross - Dot



Circle - Dot



Buck Mark Scope Base

DESCRIPTION	FINISH	CODE #	SUGG. RETAIL
Buck Mark Reflex Sight	Matte Finish	1290230	\$59.99
Buck Mark Scope Base (one-piece)	Matte Finish	12328	34.99

BUCK MARK® HI-VIZ® PISTOL SIGHT

- A great performance upgrade for the Buck Mark Pistol
- Speeds target acquisition • Fits Browning Buck Mark Plus, Camper, Standard and Micro models • Easy single screw installation, replaces factory front sight • Includes LitePipes in green and red

DESCRIPTION	CODE #	SUGG. RETAIL
Buck Mark Pistol Sight	12875	\$39.99





Flex Foam Cartridge Case

FLEX FOAM™ CARTRIDGE CASE

- Waterproof, molded foam is lightweight and comfortable
- Holds 10 centerfire rifle cartridges
- Quiet hook closure
- Double belt loop

FLEX FOAM™ CARTRIDGE CARRIER

- Durable Flex Foam construction
- Triple stitched nylon-webbed belt loop or clips to hang on belt or pants
- Folding design holds 10 centerfire rifle cartridges for easy, quick access
- Hook and loop for easy, quick open/closure



Flex Foam Cartridge Carrier

Cartridges and magazines shown are not included.



Leather Cartridge Case

LEATHER CARTRIDGE CASE

- Top-grain leather construction
- Folding design holds 10 centerfire rifle cartridges for easy, quick access
- Brass snap
- Belt loop



Crazy Horse Leather Cartridge Case

CRAZY HORSE LEATHER CARTRIDGE CASE

- Crazy Horse distressed leather construction
- Folding design holds 10 centerfire rifle cartridges for easy, quick access
- Brass snap
- Buckmark logo patch
- Available in standard and magnum cartridge models
- Belt loop

DESCRIPTION	CAPACITY	CODE #	SUGG. RETAIL
Flex Foam Cartridge Case	10 rifle cartridges	12180	\$24.99
Flex Foam Cartridge Carrier	10 rifle cartridges	12191	29.99
Leather Cartridge Case	10 rifle cartridges	12195	39.99
Crazy Horse Leather Cartridge Case	10 rifle cartridges	12198	39.99
Crazy Horse Magnum Cartridge Case	10 rifle cartridges	12199	39.99

FLEX FOAM™ ZIPPERED CHOKE TUBE CASE

- Molded foam with rugged nylon cover
- Holds five extended choke tubes
- Accessory pocket holds small items



Flex Foam Zippered Case

Choke tubes shown are not included.

LEATHER CHOKE TUBE CASE

- Accommodates four flush choke tubes and a wrench
- Belt loop



Leather Case

CRAZY HORSE LEATHER CHOKE TUBE CASE

- Accommodates four extended choke tubes and a wrench
- Belt loop



Crazy Horse Leather Case

DESCRIPTION	CAPACITY	CODE #	SUGG. RETAIL
Flex Foam Zippered, Black	5 extended choke tubes	1211130	\$29.99
Leather	4 Invector tubes and wrench	12163	29.99
Crazy Horse Leather	4 Invector tubes and wrench	12165	34.99

RIFLEMAN'S COMBO KIT

- SPORTER SLING** Features waterproof, extra-thick molded foam for the ultimate in comfort • Back side is textured for a positive, non-slip grip • Swivels not included
- TWO-PIECE NEOPRENE SCOPE COVER** Stays attached to the scope • End caps offer full protection • Fits up to 40mm scopes
- NEOPRENE BUTTSTOCK COVER** Slips over buttstock • Elastic loops hold rifle cartridges • Textured molded foam recoil pad for additional comfort

DESCRIPTION	CODE #	SUGG. RETAIL
Rifleman's Combo Kit	129240	\$59.99



Rifle, scope, mounts and cartridges not included.

HUNTER'S COMBO KIT

- SPORTER SLING** Features waterproof, extra-thick molded foam for the ultimate in comfort • Back side is textured for a positive, non-slip grip • Swivels not included
- BINO HARNESS** Keeps binoculars accessible and holds them securely on the chest to prevent bouncing • Elastic straps allow the binoculars to slide up and down the harness • Accommodates most binoculars
- NEOPRENE BUTTSTOCK COVER** Slips over buttstock • Elastic loops hold rifle cartridges • Textured molded foam recoil pad for additional comfort

DESCRIPTION	CODE #	SUGG. RETAIL
Hunter's Combo Kit	129250	\$59.99



Rifle, scope, mounts, binoculars and cartridges not included.

SCOPE COVER

- Padded neoprene is easy, fast and silent to remove • Stays attached to the scope
- End caps offer full protection
- 40mm and 50mm sizes available



Scope Cover

Cartridges, rifle, scope and binoculars shown are not included.

SHELL SAVER

- Padded neoprene cover slips over buttstock
- Flex foam™ pocket holds four rifle cartridges
- Accommodates sling swivels • Textured molded foam recoil pad

DESCRIPTION	CODE #	SUGG. RETAIL
Scope Cover, 40mm	12902	\$29.99
Scope Cover, 50mm	12904	29.99
Shell Saver	12901	29.99



Shell Saver

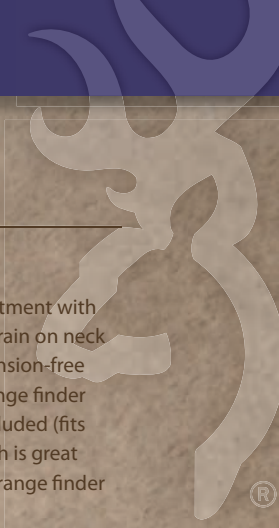

NEW BINO HUB

- Protective molded foam bino compartment with comfortable harness system relieves strain on neck
- Unique Bino attachment allows for tension-free movement
- Magnetic dual position range finder holder
- Range finder magnet wrap included (fits most range finders)
- Side stretch pouch is great for calls or accessories (Binoculars and range finder shown not included)

DESCRIPTION	CODE #	SUGG. RETAIL
NEW Bino Hub	12905	\$79.99



Powerful magnets on the side and bottom hold your range finder in the perfect position for quick use



Unique bino attachment allows tension-free viewing



Comfortable harness system eliminates strain on your neck



Backup lanyard and security bungee strap secures range finder over rough terrain



BINO HARNESS

- Keeps binoculars accessible and holds them securely on the chest to prevent bouncing
- Elastic straps allow the binoculars to slide up and down the harness
- Accommodates most binoculars (Binoculars shown not included)

DESCRIPTION	CODE #	SUGG. RETAIL
Bino Harness	12903	\$29.99



Easily attaches to most binoculars



STANDARD INVECTOR

INVECTOR-Plus™

MIDAS GRADE EXTENDED CHOKE TUBES

- Extends beyond the end of barrel for easy removal and installation • Stainless steel with black oxide finish
- Laser-etched gold accent band • Minimum gap geometry plus high-resolution "RMS" finish reduce plastic buildup in bore • Invector-Plus™ long taper choke tube technology in 12 and 20 gauge



DESCRIPTION	12 GA. CODE #	20 GA. CODE #	28 GA. CODE # (STD. INVECTOR)	.410 BORE CODE # (STD. INVECTOR)	PATTERN PERCENTAGE	SUGG. RETAIL
Extra-Full Trap	1130123	—	—	—	75-85%	\$49.99
Full	1130153	1130653	1130953	1131153	55-85%	49.99
Improved Modified	1130163	1130663	1130063	1131163	45-75%	49.99
Modified	1130173	1130673	1130073	1131173	35-65%	49.99
Light Modified	1130133	1130633	1130033	1131133	30-60%	49.99
Improved Cylinder	1130183	1130683	1130083	1131183	25-55%	49.99
Skeet	1130193	1130693	1130993	1131193	20-45%	49.99
Cylinder	1130113	—	—	—	15-45%	49.99
Spreader*	1130103	—	—	—	—	69.99
Extended 12 Ga. Choke Tube T-Wrench	1130038	—	—	—	—	19.99

* Helically rifled to spin the shot charge and spread the pattern. Flat choke tube wrench is not compatible with Midas Grade choke tubes. Pattern based on the percentage of pellets in a 30" circle at 40 yards.



STANDARD INVECTOR

INVECTOR-Plus™

DIAMOND GRADE EXTENDED CHOKE TUBES

- Longer choke taper inside Invector-Plus™ choke tubes for use with back-bored barrels on 12 and 20 gauge shotguns • Matching tubes for the Citori 625 Sporting • 17-4 stainless steel construction
- Absolutely perfect concentricity for superior patterning • Diamond-cut knurling extends beyond the end of the barrel for easy removal and installation • Titanium nitride finish with black accent band

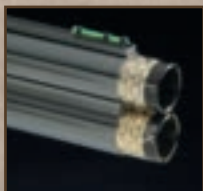

DESCRIPTION	12 GA. CODE #	20 GA. CODE #	28 GA. CODE # (STD. INVECTOR)	.410 BORE CODE # (STD. INVECTOR)	PATTERN PERCENTAGE	SUGG. RETAIL
Full	1134153	1135153	1136153	1137153	55-85%	\$69.99
Improved Modified	1134163	1135163	1136163	1137163	45-75%	69.99
Modified	1134173	1135173	1136173	1137173	35-65%	69.99
Light Modified	1134133	1135133	1136133	1137133	30-60%	69.99
Improved Cylinder	1134183	1135183	1136183	1137183	25-55%	69.99
Skeet	1134193	1135193	1136193	1137193	20-45%	69.99
Cylinder	1134113	1135113	1136113	1137113	15-45%	69.99
Extended 12 Ga. Choke Tube T-Wrench	1130038	—	—	—	—	19.99

Flat choke tube wrench is not compatible with Diamond Grade choke tubes. Pattern based on the percentage of pellets in a 30" circle at 40 yards.

DIANA GRADE EXTENDED CHOKE TUBES

- Longer choke taper inside Invector-Plus™ choke tubes for use with back-bored barrels on 12 and 20 gauge shotguns
- Stainless steel barstock is heat treated prior to machining
- Titanium nitride surface 72HRC hardness for excellent wear and reduced plastic buildup • Absolutely perfect concentricity for superior patterning • Extends beyond the barrel for easy removal and installation



STANDARD **INVECTOR-Plus™**



DESCRIPTION	12 GA. CODE #	20 GA. CODE #	28 GA. CODE # (STD. INVECTOR)	PATTERN PERCENTAGE	SUGG. RETAIL
Full	1130553	1131053	1132153	55-85%	\$59.99
Improved Modified	1130563	1131063	1132163	45-75%	59.99
Modified	1130573	1131073	1132173	35-65%	59.99
Light Modified	1130533	1131033	1132133	30-60%	59.99
Improved Cylinder	1130583	1131083	1132183	25-55%	59.99
Skeet	1130593	1131093	1132193	20-45%	59.99
Cylinder	1130513	—	—	15-45%	59.99
Spreader*	1130503	—	—		79.99
Extended 12 Ga. Choke Tube T-Wrench	1130038	—	—		19.99

* Helically rifled to spin the shot charge and spread the pattern. Flat choke tube wrench is not compatible with Diana Grade choke tubes. Pattern based on the percentage of pellets in a 30" circle at 40 yards.

INVECTOR-PLUS™ EXTENDED CHOKE TUBES

- Invector-Plus extended tubes are constructed of highly polished, 17-4 stainless steel for the ultimate in performance and durability • Available in constrictions ranging from Skeet to Full • Knurled portion extends beyond the end of the barrel for easy removal and installation • Longer choke taper inside Invector-Plus choke tubes for use with back-bored barrels • Produces excellent patterns with uniform densities • Threaded for 12 gauge Invector-Plus™ back-bored barrels only

DESCRIPTION	CODE #	PATTERN PERCENTAGE	SUGG. RETAIL
Full	1132253	55-85%	\$39.99
Improved Modified	1132263	45-75%	39.99
Modified	1132273	35-65%	39.99
Light Modified	1132233	30-60%	39.99
Improved Cylinder	1132283	25-55%	39.99
Skeet	1132293	20-45%	39.99

Pattern based on the percentage of pellets in a 30" circle at 40 yards.



INVECTOR-Plus™

SPECIALTY EXTENDED CHOKE TUBES

FULL STRUT TURKEY TUBE Stainless steel with black oxide finish • Camo band • Directional porting • Designed for optimal performance with #4, #5 and #6 shot • Threaded for 12 gauge Invector-Plus™ back-bored barrels only

EXPRESS SABOT™ RIFLED CHOKE TUBE Stainless steel with black oxide finish • Rifled design is extremely effective with both sabot and Foster slugs • Threaded for 12 gauge Invector-Plus™ back-bored barrels only

DESCRIPTION	CODE #	PATTERN PERCENTAGE	SUGG. RETAIL
Full Strut Turkey	1130500	80-85%	\$69.99
Express Sabot	1130863	N/A	79.99
Extended 12 Ga. Choke Tube T-Wrench	1130038	—	19.99

Flat choke tube wrench is not compatible with specialty choke tubes. Pattern based on the percentage of pellets in a 30" circle at 40 yards.

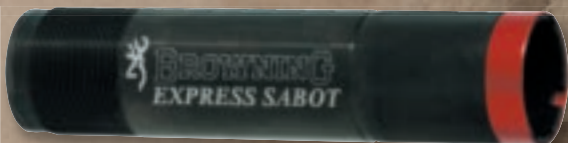
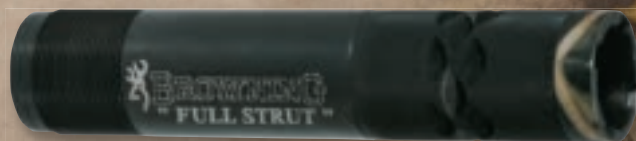

INVECTOR-Plus™

GOOSE BAND CHOKE TUBES

- Unique extended design resembles a waterfowl leg band
- 17-4 stainless steel construction • Superior patterning with steel shot • Threaded for 12 gauge Invector-Plus™ back-bored barrels only • Friction wrench is designed specifically for Goose Band choke tubes

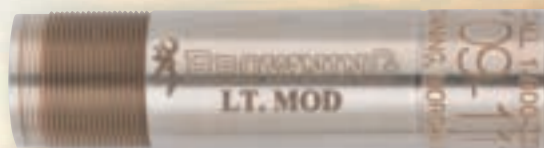

12 Gauge Friction Wrench

DESCRIPTION	CODE #	PATTERN PERCENTAGE	SUGG. RETAIL
Full	1131853	55-85%	\$69.99
Improved Modified	1131863	45-75%	69.99
Modified	1131873	35-65%	69.99
Light Modified	1131833	30-60%	69.99
Improved Cylinder	1131883	25-55%	69.99
Cylinder	1131813	15-45%	69.99
12 Ga. Choke Tube Friction Wrench	1130080	—	39.99

Flat, T-Wrench, and Speed choke tube wrenches are not compatible with Goose Band choke tubes. Pattern based on the percentage of pellets in a 30" circle at 40 yards.

INVECTOR-Plus™

GRAND PASSAGE EXTENDED CHOKE TUBES

- Mossy Oak® Duck Blind® camo band
- Stainless steel with black oxide finish
- Superior patterning with steel shot
- Threaded for 12 gauge Invector-Plus™ back-bored barrels only • Timber n' Teal model is helically spun to spin shot, making it excellent for tight timber, teal and close range shooting



DESCRIPTION	CODE #	PATTERN PERCENTAGE	SUGG. RETAIL
Full	1131453	55-85%	\$49.99
Improved Modified	1131463	45-75%	49.99
Modified	1131473	35-65%	49.99
Light Modified	1131433	30-60%	49.99
Improved Cylinder	1131483	25-55%	49.99
Timber n' Teal*	1131493	—	69.99
Extended 12 Ga. Choke Tube T-Wrench	1130038	—	19.99

** Helically rifled to spin the shot charge and spread the pattern. Flat choke tube wrench is not compatible with Grand Passage choke tubes. Pattern based on the percentage of pellets in a 30" circle at 40 yards.*

INVECTOR-Plus™



SNAP CAPS

- Precisely matches the dimensions of live 12 gauge shells • A safe way to practice trigger pull • Withstands repeated dry-firing practice • Will not harm firing pins or chambers • Sold in pairs

DESCRIPTION	CODE #	SUGG. RETAIL
Snap Caps — 12 Ga.	12465	\$29.99





Standard Invector Choke Tube

STANDARD INVECTOR CHOKE TUBES

- Standard Invector tubes are available in constrictions ranging from Cylinder to Extra-Full
- Produces excellent patterns with uniform densities
- Flush fit tubes do not extend beyond end of barrel (Except XF Trap and XF Turkey models)
- Constructed of highly polished, 17-4 stainless steel for the ultimate in performance and durability

STANDARD
INVECTOR

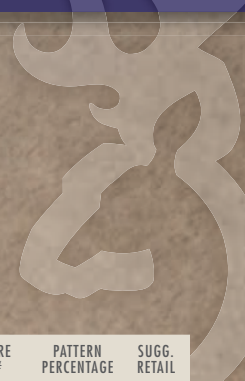

The T-Wrench allows greater leverage to be applied when tightening a tube.

DESCRIPTION	10 GA. CODE #	SUGG. RETAIL	12 GA. CODE #	16 GA. CODE #	20 GA. CODE #	28 GA. CODE #	.410 BORE CODE #	PATTERN PERCENTAGE	SUGG. RETAIL
STANDARD INVECTOR WRENCHES, CHOKE TUBES									
T-Wrench	—	—	1130013	—	1130035	1130016	1130017	—	\$19.99
Wrench	1130048	\$9.99	1130048	1130048	1130048	—	—	—	9.99
Dual Invector Wrench	1130050	12.99	1130050	1130050	1130050	—	—	—	12.99
X-Full Trap Special (Extended Tube)	—	—	1130323	—	—	—	—	75-85%	59.99
X-Full Turkey/Trap Spcl. (Extended Tube)	1130311	34.99	1130343	—	—	—	—	75-85%	59.99
Rifled Deer Spcl. Matte	—	—	1130363	—	—	—	—	N/A	69.99
Full Choke	1130251	34.99	1130253	1130254	1130255	1130256	1130257	55-85%	24.99
Improved Modified	—	—	1130263	—	—	—	—	45-75%	24.99
Modified	1130271	34.99	1130273	1130274	1130275	1130276	1130277	35-65%	24.99
Improved Cylinder	1130281	34.99	1130283	1130284	1130285	1130286	1130287	25-55%	24.99
Skeet	—	—	1130293	1130294	1130295	1130296	1130297	20-45%	24.99
Cylinder	—	—	1130303	1130304	1130305	—	—	15-45%	24.99

Pattern based on the percentage of pellets in a 30" circle at 40 yards.

INVECTOR-PLUS™ CHOKE TUBES

- Invector-Plus tubes are available in constrictions ranging from Cylinder to Extra-Full
- Longer choke taper inside Invector-Plus choke tubes for use with back-bored barrels
- Produces excellent patterns with uniform densities
- Flush fit tubes do not extend beyond end of barrel (Except XF Turkey and XF Trap models)
- Constructed of highly polished, 17-4 stainless steel for the ultimate in performance and durability

INVECTOR-Plus™



The Speed Wrench allows for quick and easy choke removal. Fits most Browning choke tubes.



The T-Wrench allows greater leverage to be applied when tightening a tube.



Invector-Plus Choke Tube

DESCRIPTION	12 GA. CODE #	20 GA. CODE #	PATTERN PERCENTAGE	SUGG. RETAIL
INVECTOR-PLUS WRENCHES, CHOKE TUBES				
T-Wrench	1130023	1130035	—	\$19.99
Speed Wrench	1130060	1130070	—	39.99
Wrench	1130053	—	—	9.99
Dual Invector Wrench	1130050	1130050	—	12.99
X-Full Turkey/Trap Spcl. (Extended Tube)	1130833	—	75-85%	59.99
Full	1130753	1130755	55-85%	29.99
Improved Modified	1130763	—	45-75%	29.99
Modified	1130773	1130775	35-65%	29.99
Improved Cylinder	1130783	1130785	25-55%	29.99
Skeet	1130793	1130795	20-45%	29.99
Cylinder	1130803	1130805	15-45%	29.99

Pattern based on the percentage of pellets in a 30" circle at 40 yards.

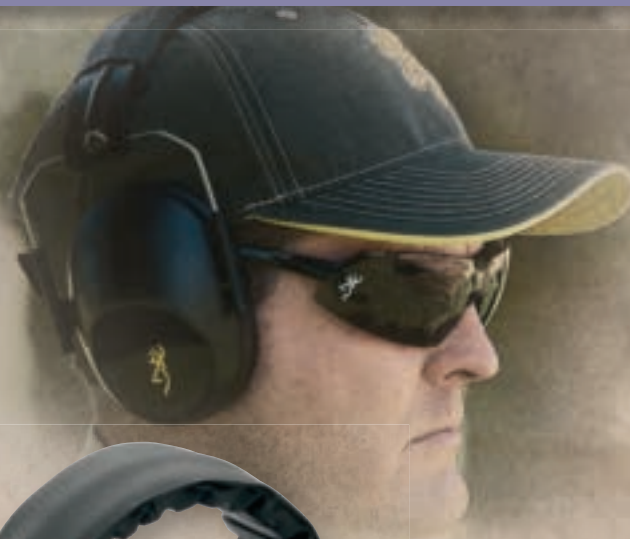

BUCKMARK® HEARING PROTECTOR FOR HER

- Pink adds a feminine touch
- Unobtrusive low-profile design
- Soft, comfortable foam ear cups
- Foldable padded headband
- NRR 31dB



BUCKMARK® HEARING PROTECTOR

- Unobtrusive low-profile design
- Soft, comfortable foam ear cups
- Foldable padded headband
- NRR 31dB



NEW

BUCKMARK MOSSY OAK® BREAK-UP INFINITY® HEARING PROTECTOR

- Low profile design makes for easy gun mounting
- Soft, comfortable foam ear cups
- Foldable padded headband • NRR 31dB
- Mossy Oak® Break-Up Infinity®



Runs on 2 AA Batteries

MIDAS™ ELECTRONIC HEARING PROTECTOR

- Sharp noises are reduced while normal speech and sounds are amplified
- On/off volume controls • Fast reaction time of 6 milliseconds • Operates on two AA batteries (not included) • 100-120 hours per set of batteries with LED battery life indicator • NRR 28dB



DESCRIPTION	CODE #	SUGG. RETAIL
Buckmark Hearing Protector For Her	12681	\$19.99
NEW Buckmark MOINF Hearing Protector	12658	39.99
Buckmark Hearing Protector	12680	19.99
Midas Electronic Hearing Protector	12627	69.99



NEW

HDR HEARING PROTECTOR

- Our best hearing protector with decibel reduction of NRR 37db
- Soft, comfortable foam ear cups
- Padded and adjustable headband
- Buckmark logo



NEW

ECLIPSE HEARING PROTECTOR

- Adjustable, padded headband compacts down for easy storage
- Unique Browning corporate design
- Soft, padded ear cups • NRR 31d



NEW

BEHIND THE HEAD HEARING PROTECTOR

- Lightweight and compact
- Fits comfortably behind the head when wearing a hat
- Contoured cup design • NRR 22db



DESCRIPTION	CODE #	SUGG. RETAIL
NEW HDR Hearing Protector	12699	\$39.99
NEW Eclipse Hearing Protector	12684	29.99
NEW Behind the Head Hearing Protector	12685	29.99

BROWNING DUO EARPLUGS

- Insert yellow end for variable level protection, such as at outdoor ranges
- Use olive end for a constant NRR of 22dB for indoor ranges
- Selected for use by U.S. military and NATO

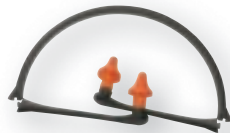

NEW

BANDED PLUGS

- Foam earplugs contour to your outer ear canal for comfortable fit
- Plastic headband fits comfortably around your head or neck
- Comes with removable foam plugs
- Folds up for easy storage
- NRR 22
- Includes one set of replaceable foam ear plugs



DESCRIPTION	CODE #	SUGG. RETAIL
NEW Banded Plugs	12686	\$9.99

DESCRIPTION	CODE #	SUGG. RETAIL
Browning Duo Earplugs	12640	\$19.99



RANGE KITS

- Shooting glasses with orange tinted polycarbonate lenses offer both eye protection and enhanced target visibility • Soft foam earplugs provide noise reduction up to 31dB and come with a plastic storage case (shown)
- Adjustable-fit earmuffs with padded headband have a noise reduction rating of 27dB

FOR HER RANGE KIT Buckmark® shooting glasses with smoke polycarbonate lenses and light pink frames offer eye protection and enhanced target visibility in bright conditions • Pink soft foam earplugs provide noise reduction up to 31dB and come with a plastic storage case • Adjustable-fit For Her earmuffs with padded headband have a noise reduction rating of 31dB

DESCRIPTION	CODE #	SUGG. RETAIL
Range Kit	126368	\$29.99
Range Kit For Her	126369	29.99

CLAYMASTER™ SHOOTING GLASSES

- High-grade polycarbonate lenses offer 99% UV protection
- Interchangeable orange, yellow, clear, smoke and blue colored lenses included • Fully adjustable frames include ratchet pitch adjustment, expandable temple length and height adjustable nose pads • Padded case and microfiber bag are included (not shown)

DESCRIPTION	CODE #	SUGG. RETAIL
Claymaster Shooting Glasses	12715	\$39.99



ACE SHOOTING GLASSES

- High-grade polycarbonate lenses offer 99% UV protection • Interchangeable vermilion, orange and yellow colored lenses included • Lightweight frames
- Rubberized nose and temple pads • Microfiber bag is included (not shown)

DESCRIPTION	CODE #	SUGG. RETAIL
Ace Shooting Glasses	12717	\$29.99



BUCKMARK® SHOOTING GLASSES

- Suspended lens offers an unobstructed view, maximum protection, stylish looks and 99% UV protection • Wrap-around polycarbonate lens offers side protection • Frames include ratcheted pitch adjustment • Non-slip three position adjustable nosepiece • Rugged polycarbonate frame with non-slip temples • Available with choice of clear, orange or smoke lenses • Pink model comes with smoke lenses • Microfiber bag included (not shown)

DESCRIPTION	CODE #	SUGG. RETAIL
Buckmark Shooting Glasses For Her, Smoke	12721	\$19.99
Buckmark Shooting Glasses, Clear	12718	19.99
Buckmark Shooting Glasses, Smoke	12719	19.99
Buckmark Shooting Glasses, Orange	12720	19.99





HIVIZ® BIRD BUSTER MAGNETIC SHOTGUN SIGHTS

• HiViz Bird Buster magnetic sights come with four interchangeable LitePipes of different diameters for different light conditions • Includes three sizes of magnetic bases to fit the rib on any shotgun • Mounts easily with no gunsmithing required • Fits all Browning shotguns

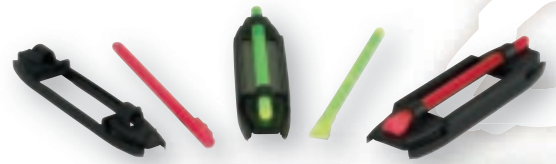

DESCRIPTION	CODE #	SUGG. RETAIL
Bird Buster Sight	12859	\$19.99

HIVIZ® COMP SIGHT

• Metal base threads directly into the bead of shotguns for a more permanent sight picture • Interchangeable LitePipes allow shooter to match light pipe diameter and color to shooting conditions • Includes one white, four green and three red LitePipes • Used by top professional shooters • Allows the shooter to know exactly where the barrel is in relation to the target • Metal base • Five screw sizes, 3/56, 3x.5, 3x.6, 5/40 and 6/48 to fit most shotguns • Key and custom carrying case included (not shown)



DESCRIPTION	CODE #	SUGG. RETAIL
Comp Sight	12850	\$39.99



HIVIZ® 4-IN-1 GAME SIGHT

• Includes both front and rear sights, making the 4-in-1 perfect for deer, turkey, waterfowl and upland hunting • Injection-molded optical-grade resin sight construction • Rear sight is fully adjustable for windage and elevation • Light-gathering LitePipes make low-light shooting effortless • Mounts easily with no gunsmithing required

DESCRIPTION	CODE #	SUGG. RETAIL
4-in-1 Game Sight	12893	\$39.99

MINI COMP SIGHT

• Metal base replaces bead sight • Interchangeable light pipes include orange, red and green • Includes five different screws for mounting • Adjustment key holds two extra LitePipes • Fits most shotguns



DESCRIPTION	CODE #	SUGG. RETAIL
NEW Mini Comp	12851	\$24.99
NEW 2-1 Hunting	12871	29.99
NEW 2-1 Sporting	12872	29.99

2-1 HUNTING AND 2-1 SPORTING SIGHTS

• Magnetic base attaches directly to shotgun rib • Each sight features both red and green LitePipes • Simply reverse sight to change color that is seen • Comes with both round and triangular LitePipe systems • Hunter model is designed specifically for guns with narrow ribs • Sporting model is designed specifically for guns with wider ribs



GUN CLEANING MAT

- The safe way to protect both firearms and furniture • Soft, felt-like fabric won't damage firearms • Waterproof Zorb Tech™ backing stops spills from migrating and inhibits the soak-through of cleaners • Mat measures 16" x 54" for plenty of room while keeping small parts in their places and organized • Washable, dryable, highly stain-resistant



DESCRIPTION	DIMENSIONS	CODE #	SUGG. RETAIL
Gun Cleaning Mat	16" x 54"	12420	\$19.99

UNIVERSAL CLEANING KIT

- 35-piece kit is packaged in a fitted aluminum frame carry case with handle and contains two sets of solid brass cleaning rods: One for small caliber rifles and pistols (.17-.280) and one for large caliber rifles, pistols (.30 and larger) and shotguns • Ten wire brushes, .17-.45 cal. including three shotgun brushes 12 ga., 20 ga., and .410 bore • Six wool mops from .17 cal. to 12 gauge • Includes six jags, two slotted patch holders, brush adaptors, one PSH handle, handle adaptor and 50 cleaning patches



DESCRIPTION	CODE #	SUGG. RETAIL
Universal Cleaning Kit	12444	\$49.99

STEP 1 CARBON REMOVER

- Proprietary formula quickly removes carbon build up • Evaporates quickly • Contains no ammonia, pH neutral • Pinpoint applicator • 4 oz. bottle

STEP 2 BORE POLISH

- Proprietary formula improves bore condition while safely removing accuracy-harming copper build up • Removes copper, lead and powder residue • Evaporates quickly • Contains no ammonia, pH neutral • Pinpoint applicator • 4 oz. bottle

STEP 3 SOLVENT AND DEGREASER

- Safely removes residue from Carbon and Bore Polish cleaners • Fast-drying solvent displaces water • Contains no chlorine, ozone safe • Rapidly cuts through oil and grease • Leaves no residue • 19 fl. oz. aerosol can

STEP 4 GUN OIL

- Proprietary formula passes strict military requirements • Low surface tension provides excellent lubrication and corrosion protection • Contains no synthetics • Pinpoint applicator on 2 oz. bottle • 6 fl. oz. aerosol can



PRE-PACKAGED 4-STEP GUN CLEANER

- Includes Carbon Cleaner, Bore Polish, Solvent Degreaser and Gun Oil



DESCRIPTION	SIZE	CODE #	SUGG. RETAIL
Step 1 Carbon Remover, 4 oz. Applicator	4 oz.	124023	\$9.99
Step 2 Bore Polish, 4 oz. Applicator	4 oz.	124024	12.99
Step 3 Solvent and Degreaser, 19 oz. Aerosol	19 oz.	124025	9.99
Step 4 Gun Oil, 2 oz. Applicator	2 oz.	124032	7.99
Step 4 Gun Oil, 6 oz. Aerosol	6 oz.	124040	12.99
Prepack 4-Step Gun Cleaner	—	123400	39.99

CLEAN YOUR FIREARMS.

We make the best guns in the world, but regardless of the brand, use our cleaning kits and tools to keep all of your firearms in top condition. Select a 32-piece Gun Cleaning Kit, a 51-piece Screwdriver Tool Set or an All-Purpose Kit with pad, a side panel full of mops, rods and tips which all roll up into its own cleaning mat. Show your pride in keeping all of your firearms in impeccable condition with a Browning gun kit.



NEW

32-PIECE GUN CLEANING KIT

- 3-piece brass cleaning rod with machined aluminum handle
- Includes bronze brushes, mops, slot-tip jags and adaptors
- Cleaning pick and double-ended utility brush
- Polishing cloth and 25 cleaning patches
- Custom-fit EVA soft-sided case with removable bandoliers and accessory pouches

SCREWDRIVER TOOL SET

- 51-piece set
- Small, compact and convenient
- Double-injected form fitted case
- Custom molded driver with magnetic tip
- 12 flat head bits, 8 hex bits, 4 Phillips bits, 2 extra-long Phillips bits, 7 Torx® bits, 4 Robertson bits, 4 Tri-wing bits, 3 Clutch bits, 2 spline bits, 3 Torq® bits and one, 1" socket adaptor



NEW

ALL-PURPOSE CLEANING KIT

- Three-layer cleaning pad
- Soft polyester fleece top won't scratch guns
- Middle spill-proof barrier helps prevent cleaning fluids from soaking through
- Durable bottom base prevents slipping
- Side panel includes 24-piece cleaning kit
- Cleaning kit includes brass rods, bristles, mops, slot tips and jags for all standard calibers and gauges
- Rolls up into one convenient package

NEW



DESCRIPTION	CODE #	SUGG. RETAIL
NEW 32-Piece Kit	12445	\$39.99
NEW Screwdriver Set	12401	29.99
NEW All-Purpose Set	12443	69.99

HUNTING DOGS PREFER BROWNING KENNEL GEAR.

At Browning we understand the strong and lasting bond between a hunter and his dog. For 2012 we're introducing a complete line of high quality kennel accessories to help make sure your hunting dogs are safe, healthy and properly trained for the game you pursue. Training hunting dogs right takes dedication, patience and determination and your dogs will learn faster when you're using Browning training accessories in your kennel. They're constructed of the highest quality materials so they'll stand up to years of heavy use. Our kennel gear is just what your four-legged hunting partners need, at home and in the field.



BUCKMARK® TRAINING BUMPERS **NEW**

- Heavy duty polymer resists wear and tear
- Raised Buckmark logos improve grip
- Valveless design eliminates leaking and aids buoyancy
- Yellow color is highly visible against most backgrounds
- Black color is best against bright or light colored backgrounds
- Sliding throw rope
- Large 3" x 12" size is perfect for larger dogs and simulate larger birds
- Small 2" x 10" size is ideal for smaller or younger dogs and for their initial retrieve training



Large Bumpers

Small Bumpers

DESCRIPTION	DIMENSIONS	CODE #	SUGG. RETAIL
NEW Buckmark Bumpers, Large, Black/Yellow	3" x 12"	1304009903	\$9.99
NEW Buckmark Bumpers, Large, Yellow/Black	3" x 12"	1304006303	9.99
NEW Buckmark Bumpers, Small, Black/Yellow	2" x 10"	1304009901	7.99
NEW Buckmark Bumpers, Small, Yellow/Black	2" x 10"	1304006301	7.99

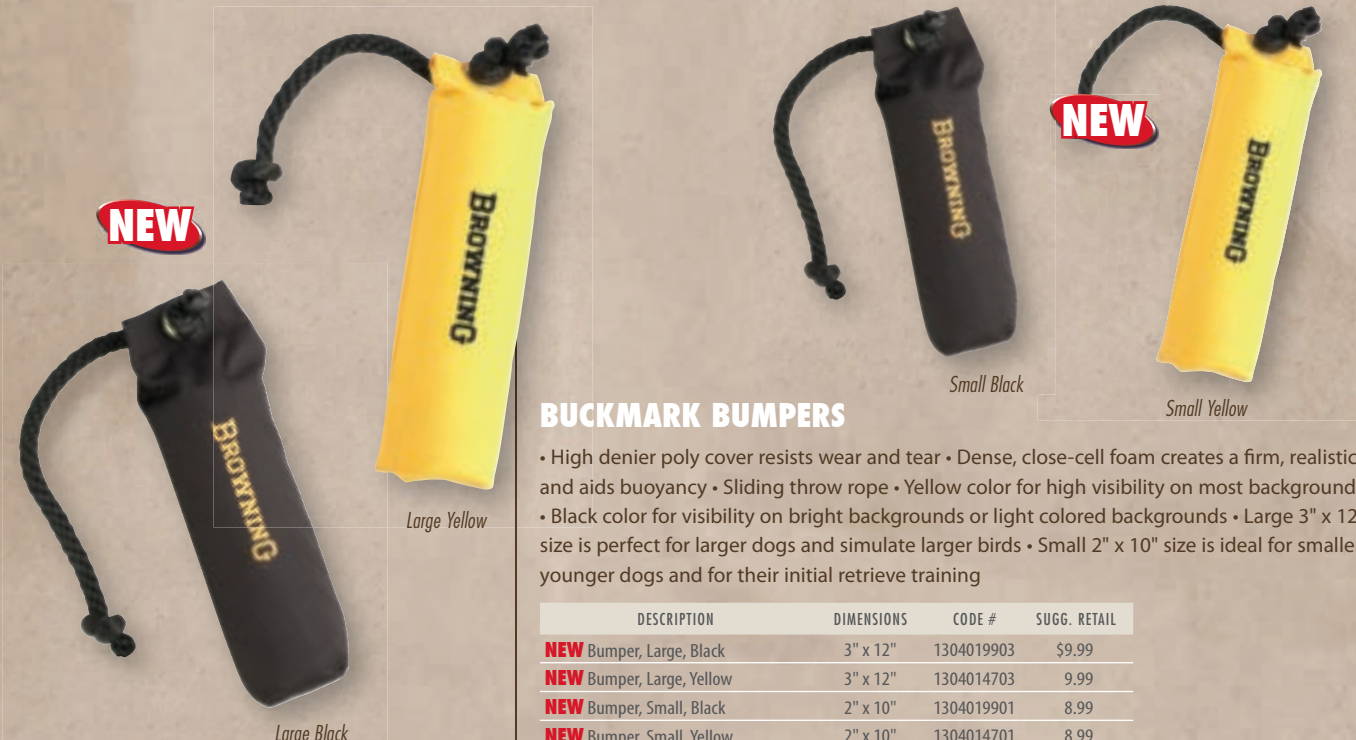

Large Yellow

Small Black

Small Yellow

Large Black

BUCKMARK BUMPERS

- High denier poly cover resists wear and tear
- Dense, close-cell foam creates a firm, realistic feel and aids buoyancy
- Sliding throw rope
- Yellow color for high visibility on most backgrounds
- Black color for visibility on bright backgrounds or light colored backgrounds
- Large 3" x 12" size is perfect for larger dogs and simulate larger birds
- Small 2" x 10" size is ideal for smaller or younger dogs and for their initial retrieve training

DESCRIPTION	DIMENSIONS	CODE #	SUGG. RETAIL
NEW Bumper, Large, Black	3" x 12"	1304019903	\$9.99
NEW Bumper, Large, Yellow	3" x 12"	1304014703	9.99
NEW Bumper, Small, Black	2" x 10"	1304019901	8.99
NEW Bumper, Small, Yellow	2" x 10"	1304014701	8.99

DOG BEDS

NEW

- Removable, heavy-duty shell fabric • Washable
- Comfortable, recycled polyester fill • Buckmark logo

DESCRIPTION	CODE #	SUGG. RETAIL
NEW Buckmark Round Dog Bed, 50"	13002050	\$49.99
NEW Buckmark Rectangle Dog Bed, 54"	13002154	49.99



Round Bed



Rectangle Bed

GIVE YOUR DOGS THE REST THEY DESERVE.

After a long day in the field your hard-working dogs deserve a good night's sleep on a quality Browning Dog Bed. Get one that is comfortable and fits them properly, with lots of room to stretch out and relax their tired muscles. Both round and rectangular models are available to fit the available space in the kennel or around your home.

KEEP YOUR DOGS SAFE AND WARM IN A BROWNING DOG VEST.

Give your dogs the protection they deserve from sharp branches, thorns and stones with a Browning Dog Vest. The Neoprene Vest adds warmth to your dog's core while they sit in a damp blind or boat. The Safety Vest lets everyone in your party know where your dogs are when hunting in dense cover or tall grass.



NEW

Neoprene Vest, RTM-4



NEW

Neoprene Vest, MODB

NEOPRENE VESTS

- Neoprene vest is designed for warmth and protection • Abrasion-resistant fabric on chest and belly for added protection • Fully protected back zipper closure • Removable floats on sides for additional buoyancy • Multiple bar tacks ensure vest's integrity after customizing leg holes to fit your dog

DESCRIPTION	CODE #	SUGG. RETAIL
NEW Neoprene Vest, RTM-4, Small	1303002201	\$49.99
NEW Neoprene Vest, RTM-4, Medium	1303002202	49.99
NEW Neoprene Vest, RTM-4, Large	1303002203	49.99
NEW Neoprene Vest, RTM-4, Extra Large	1303002204	49.99
NEW Neoprene Vest, MODB, Small	1303001701	49.99
NEW Neoprene Vest, MODB, Medium	1303001702	49.99
NEW Neoprene Vest, MODB, Large	1303001703	49.99
NEW Neoprene Vest, MODB, Extra Large	1303001704	49.99

NEOPRENE VEST SIZE	CHEST	NECK	STOMACH
Small	24" & Under	Under 17"	23" & Under
Medium	26" & Under	Under 19"	24" & Under
Large	29" & Under	Under 22"	27" & Under
Extra Large	31" & Under	Under 23"	29" & Under

SAFETY VESTS

- High visibility blaze orange for added safety • Abrasion-resistant fabric on chest and belly for added protection • Web straps easily adjust to fit various breeds and sizes of dogs

DESCRIPTION	CODE #	SUGG. RETAIL
NEW Safety Vest, Blaze, Small	1303010101	\$19.99
NEW Safety Vest, Blaze, Medium	1303010102	19.99
NEW Safety Vest, Blaze, Large	1303010103	19.99
NEW Safety Vest, Blaze, Extra Large	1303010104	19.99



NEW

Safety Vest, Blaze

PUT YOUR DOGS ON THE BEST DRESSED LIST.

After all that training, your dogs have earned a fine collar. Our collars are strong, functional and set your dog apart as a true Browning fan. We have the perfect collar in four different sizes and over 40 models. Don't let your dogs leave home without one.

FIELD COLLARS

NEW

- Top grain latigo leather or double-ply webbing • Heavy-duty hardware • Safety center ring allows dog to escape if caught in fence or thickets • D-ring for attaching lead or tie-out



DESCRIPTION	CODE #	SUGG. RETAIL
NEW Field Collar, Leather, 17"	1301008817	\$19.99
NEW Field Collar, Leather, 19"	1301008819	19.99
NEW Field Collar, Leather, 21"	1301008821	19.99
NEW Field Collar, Leather, 23"	1301008823	19.99
NEW Field Collar, Blaze, 17"	1301000117	14.99
NEW Field Collar, Blaze, 19"	1301000119	14.99
NEW Field Collar, Blaze, 21"	1301000121	14.99
NEW Field Collar, Blaze, 23"	1301000123	14.99
NEW Field Collar, Black, 17"	1301009917	14.99
NEW Field Collar, Black, 19"	1301009919	14.99
NEW Field Collar, Black, 21"	1301009921	14.99
NEW Field Collar, Black, 23"	1301009923	14.99
NEW Field Collar, Yellow, 17"	1301007317	14.99
NEW Field Collar, Yellow, 19"	1301007319	14.99
NEW Field Collar, Yellow, 21"	1301007321	14.99
NEW Field Collar, Yellow, 23"	1301007323	14.99



Leather Blaze Black Yellow



Measure your dog's neck at the smallest part with a flexible measuring tape. Our collars are sized from the buckle to the middle adjustment hole to allow room for your dog's growth and seasonal weight changes.

HYDRO-COAT COLLARS

NEW

- Poly-coated water-resistant webbing • Won't mildew, rot or stink • Heavy-duty hardware • Safety center ring allows dog to escape if caught in fence or thickets • D-ring for attaching lead or tie-out

DESCRIPTION	CODE #	SUGG. RETAIL
NEW Hydro-Coat Collar, Black, 17"	1301019917	\$14.99
NEW Hydro-Coat Collar, Black, 19"	1301019919	14.99
NEW Hydro-Coat Collar, Black, 21"	1301019921	14.99
NEW Hydro-Coat Collar, Black, 23"	1301019923	14.99
NEW Hydro-Coat Collar, Blaze, 17"	1301010117	14.99
NEW Hydro-Coat Collar, Blaze, 19"	1301010119	14.99
NEW Hydro-Coat Collar, Blaze, 21"	1301010121	14.99
NEW Hydro-Coat Collar, Blaze, 23"	1301010123	14.99



Black Blaze



ADJUSTABLE COLLARS

NEW

- Single ply webbing • Heavy-duty hardware
- D-ring for attaching lead or tie-out • Ladder adjustment for sizing

DESCRIPTION	CODE #	SUGG. RETAIL
NEW Adjustable Collar, Black, 14"-20"	1301039914	\$9.99
NEW Adjustable Collar, Black, 18"-26"	1301039918	9.99
NEW Adjustable Collar, Yellow, 14"-20"	1301037314	9.99
NEW Adjustable Collar, Yellow, 18"-26"	1301037318	9.99
NEW Adjustable Collar, Blaze, 14"-20"	1301030114	9.99
NEW Adjustable Collar, Blaze, 18"-26"	1301030118	9.99



Black

Yellow

Blaze

CLASSIC STANDARD COLLARS

NEW

- Single ply webbing • Heavy-duty hardware
- D-ring for attaching lead or tie-out

DESCRIPTION	CODE #	SUGG. RETAIL
NEW Classic Collar, Black, 17"	1301029917	\$9.99
NEW Classic Collar, Black, 19"	1301029919	9.99
NEW Classic Collar, Black, 21"	1301029921	9.99
NEW Classic Collar, Black, 23"	1301029923	9.99
NEW Classic Collar, Yellow, 17"	1301027317	9.99
NEW Classic Collar, Yellow, 19"	1301027319	9.99
NEW Classic Collar, Yellow, 21"	1301027321	9.99
NEW Classic Collar, Yellow, 23"	1301027323	9.99
NEW Classic Collar, Blaze, 17"	1301020117	9.99
NEW Classic Collar, Blaze, 19"	1301020119	9.99
NEW Classic Collar, Blaze, 21"	1301020121	9.99
NEW Classic Collar, Blaze, 23"	1301020123	9.99

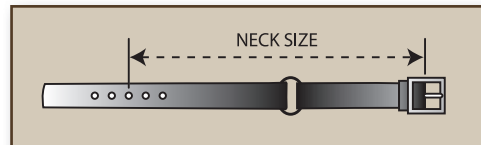

Measure your dog's neck at the smallest part with a flexible measuring tape. Our collars are sized from the buckle to the middle adjustment hole to allow room for your dog's growth and seasonal weight changes.



Black

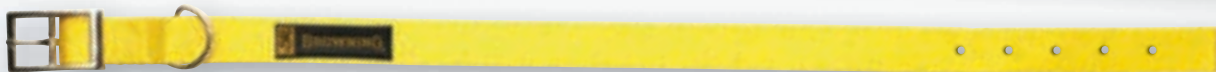

Yellow



Blaze



GIVE YOUR DOGS A NEW LEASH ON LIFE.

Get your dog a new Browning leash and take her for a walk in high style. Select latigo leather, nylon webbing or a fine woven rope model. Heavy-duty snap rings and loop handles insure a secure hold. Leads come in either 4 foot or 6 foot lengths. A training lead or walking lead is a great idea and can help make your dog feel more secure, especially when there are other dogs, cars and children around.

LEATHER LEADS **NEW**

- Top-grain latigo leather • Heavy-duty brass snap hook • Loop handle • 4' length

WALKING LEADS **NEW**

- Single ply webbing • Heavy duty snap hook • Loop handle
- 4 foot and 6 foot lengths • Neoprene handle



	DESCRIPTION	CODE #	SUGG. RETAIL
NEW	Latigo Leather, 4'	1302008804	\$24.99
NEW	Walking Lead, Black, 4'	1302019904	19.99
NEW	Walking Lead, Black, 6'	1302019906	24.99
NEW	Walking Lead, Yellow, 4'	1302017304	19.99
NEW	Walking Lead, Yellow, 6'	1302017306	24.99
NEW	Walking Lead, Blaze, 4'	1302010104	19.99
NEW	Walking Lead, Blaze, 6'	1302010106	24.99



Leather, Latigo

Walking, Black

Walking, Blaze

Walking, Yellow

Training, Blaze

Training, Black

Training, Yellow



The collar end has a traffic loop that allows tighter control over your dog.



The loop end of the lead can be easily secured around a post or tree.

NEW TRAINING LEADS

- Single ply webbing • Sliding adjustable buckle design allows you to expand and clip the handle around your waist, belt, post or tree • Snap link end has an integrated traffic handle for more control of your dog

	DESCRIPTION	CODE #	SUGG. RETAIL
NEW	Training Lead, Black, 6'	1302029906	\$24.99
NEW	Training Lead, Yellow, 6'	1302027306	24.99
NEW	Training Lead, Blaze, 6'	1302020106	24.99



CHECK OUT OUR SLIP LEADS AND CHECK CORDS.

High-drive hunting dogs can get pretty excited. When they do you'll want a slip lead or check cord to remind them just who's in charge. Choose from solid core or multi-filament rope construction that's durable and effective. All slip leads come in either 4 foot or 6 foot lengths. The check cords are a generous 30 feet in length to give your dogs plenty of room to roam and explore while still keeping them close at hand and easy to control.

ROPE SLIP LEADS **NEW**

- Braided multi-filament rope • Resists wear and is semi-buoyant • Heavy-duty O-Ring • Adjustable keeper • Slip collar design allows for easy one-handed correction • 4 foot and 6 foot lengths

DESCRIPTION	CODE #	SUGG. RETAIL
NEW Rope Slip Lead, Black, 4'	1302039954	\$19.99
NEW Rope Slip Lead, Black, 6'	1302039956	24.99
NEW Rope Slip Lead, Brown Camo, 4'	1302033854	19.99
NEW Rope Slip Lead, Brown Camo, 6'	1302033856	24.99

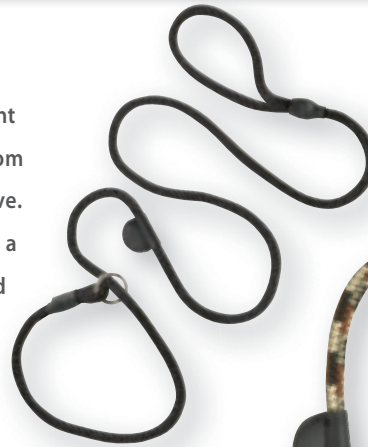

Slip Lead, Black



Slip Lead, Brown Camo

ROPE LEADS **NEW**

- Braided multi-filament rope • Resists wear and is semi-buoyant • Heavy-duty snap hook • 4 foot and 6 foot lengths



Rope Lead, Brown Camo

DESCRIPTION	CODE #	SUGG. RETAIL
NEW Rope Lead, Black, 4'	1302039904	\$19.99
NEW Rope Lead, Black, 6'	1302039906	24.99
NEW Rope Lead, Brown Camo, 4'	1302033804	19.99
NEW Rope Lead, Brown Camo, 6'	1302033806	24.99

ROPE CHECK CORDS **NEW**

- Diamond braided rope features a solid core • Resistant to tangling or knotting • Highly buoyant for water training • Allows for long distance control of your dog • 30 foot open-ended rope allows dog to run free without getting snagged

DESCRIPTION	CODE #	SUGG. RETAIL
NEW Rope Check Cord, Black, 30'	1302049930	\$29.99
NEW Rope Check Cord, Blaze, 30'	1302040130	29.99



Rope Check Cord, Black



Rope Check Cord, Blaze

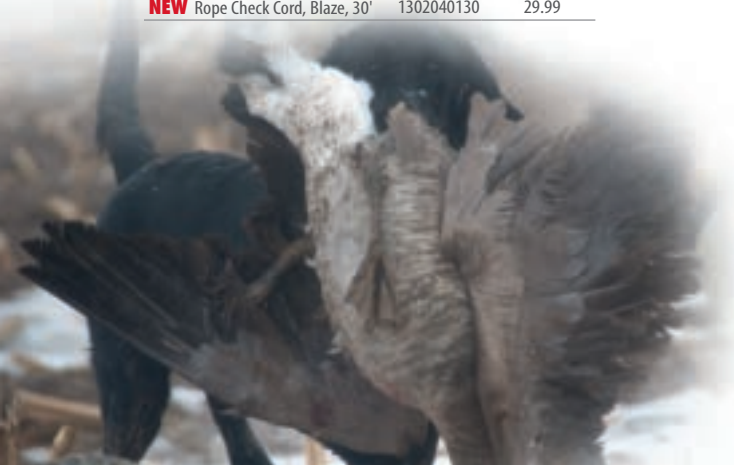



WATER/FEED BOWLS

• Stainless steel water/feed bowl has angled base to prevent tipping • Rubberized bottom prevents sliding and won't mar floors • 8½" x 2¾" size • Laser-etched Buckmark logo



Water/Feed Bowl

NEW

WATER BOX

• Unique self-filling design • Vacuum pressure keeps reservoir full without overflowing • Trapped air pressure in the well forces water to fill up reservoir while your dog drinks • Tip the box back to fill the well and set on level surface to fill the reservoir • Tip the box on its back and the well holds 2½ gallons of water without spilling for easy transportation • 11" x 10" size



Water Box

NEW

	DESCRIPTION	DIMENSIONS	CODE #	SUGG. RETAIL
NEW	Water Bowl, Non-tip Stainless Steel	8½" x 2¾"	13000100	\$14.99
NEW	Water Box, Stainless Steel	11" x 10"	13000201	\$9.99

BALL WHISTLES

• Constructed of durable plastic • Ball style for general training purposes • Allows you to "trill" the whistle • Comes with lanyard



NEW



BALL-FREE WHISTLES

• Constructed of durable plastic • Ball-free design won't freeze up in cold weather • Excellent for making quick blasts of sounds for training purposes • Comes with lanyard



NEW



	DESCRIPTION	CODE #	SUGG. RETAIL
NEW	Ball Whistle, Black	13005099	\$4.99
NEW	Ball Whistle, Yellow	13005063	4.99
NEW	Ball-Free Whistle, Black	13005199	4.99
NEW	Ball-Free Whistle, Yellow	13005163	4.99
NEW	Brass Bell	13006000	9.99

NEW



BRASS BELL

• Brass construction • Great for locating a dog in heavy cover • Weighs 1.2 oz. • 2" x 1½" • Webbing strap slides into 1" dog collar



KNIVES —

THE MOST ESSENTIAL TOOL.

The knife is one of mankind's oldest and most basic tools. Over the ages a good knife was a means of finding and preparing food, building a shelter, starting a fire and keeping the wild dingos from stealing your supper. Today a sharp knife can be just as important. Whether hunting, backpacking, fishing or working around your home, keeping a sharp knife handy always makes good sense. We offer a wide selection of razor-sharp blades and attractive handle materials to meet every use you can imagine. From dressing big game to filleting fish, from braving the wilderness to whittling by the campfire, give yourself a sharper edge with a Browning knife.



RUSS KOMMER

For nearly 30 years Russ Kommer has earned his living as a highly respected big game hunting guide in Idaho and the wilds of Alaska. The work of a guide doesn't end with leading clients to trophy game animals; it starts there. Once an animal is on the ground the real work begins. Over the years Russ used many knives to dress and skin countless animals, yet found each knife lacking in performance. He drew upon his wealth of hands-on experience and started designing and producing his own knives. It turned out that Russ had a knack for this art and has become a talented, award-winning knifemaker. What started as a hobby and the search for a better blade has led to numerous best-in-show awards. Russ creates and personally field tests his designs to ensure they meet the toughest standards — his own. Browning is honored to team with Russ to produce many of the knives throughout this catalog.



KNIVES

DECLARE YOUR INDEPENDENCE.

There was a time in the not so distant past when nearly everything you purchased was built in America, and the term Made in the USA stood for the highest quality. Made in the USA still means something special to us, and that's why we're proud to offer the Independence Series knives. This collection was designed in the USA by famed knifemaker Russ Kommer. All the materials are sourced from American companies, and the knives themselves are built here in the USA. Their quality is evident from first glance. Functional designs have been tried and tested in real-world hunting situations to make certain their balance is perfect and their blades stay sharp. Get your hands on an Independence Series knife and take a bit of homegrown Browning quality into the field on your next hunting trip.

**Designed
in the USA
by
Russ Kommer**



INDEPENDENCE KNIVES

TYPE Fixed blade knives

BLADES USA 154 CM stainless steel

HANDLES G-10 **FEATURES** Includes a Made in USA top-grain leather sheath

MODEL	DESCRIPTION	BLADE LENGTH	CODE #	SUGG. RETAIL
744	Independence, Fixed Blade, Black	3¾"	322744	\$99.95
745	Independence, Fixed Blade, Olive Drab G-10	3¾"	322745	99.95
746	Independence, Fixed Blade, Blaze G-10	3¾"	322746	99.95



SHE'LL LOVE IT!

With perfectly-balanced blades, handles with smaller dimensions and designs that are just plain cute, new Browning For Her knives are designed for women who take the outdoors seriously. If pink isn't your thing, a bone handle is also available. All knives feature a rugged nylon sheath and the folders also include a handy pocket clip.



894



895



For Her 717 includes a handy Kydex® sheath with neck chain, making it perfect for everyday use and self-defense

NEW



717



892



893

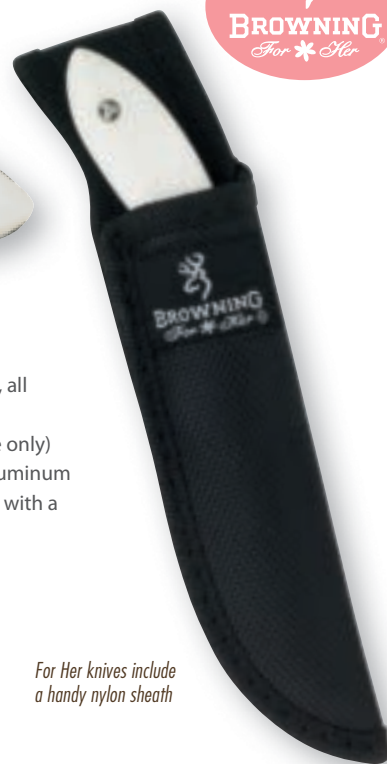

For Her knives include a handy nylon sheath

BROWNING FOR HER KNIVES

TYPE Fixed blade or folding locking liner **BLADE** #717 has 440 stainless blade, all others have Swedish Sandvik® 12C27 stainless steel **HANDLE** Aluminum with Dura-Touch® Armor Coating or genuine bone with mosaic pins (fixed blade only)
 • Fixed blade models have stainless steel bolsters, folders have anodized aluminum
FEATURES Fixed blade models include a rugged nylon sheath • Folders come with a rugged nylon sheath and pocket clip



MODEL	DESCRIPTION	BLADE	CODE #	SUGG. RETAIL
894	Browning For Her, Folder, Mossy Oak Pink	2¾"	322894	\$24.95
895	Browning For Her, Folder, Bone	2¾"	322895	24.95
892	Browning For Her, Fixed Blade, Mossy Oak Pink	2⅞"	322892	34.95
893	Browning For Her, Fixed Blade, Bone	2⅞"	322893	34.95
717	NEW Spur Neck Knife For Her, Mossy Oak Pink	1¾"	322717	19.95

RICHLY DETAILED.

Long ago, when ships with sails ruled the waves, ivory carving was a popular hobby for sailors who spent months at sea with little to do except swab decks. While not carved from real ivory, Browning Scrimshaw knives feature richly detailed game scenes skillfully crafted into replica handles.

SCRIMSHAW KNIVES

TYPE Folding lockbacks **BLADES** Hollow ground, satin-finished 420-J2 stainless steel • Laser-engraved Buckmark logo
HANDLES Finely polished zinc casting for heft and balance • Laser-engraved Buckmark logo • Adorned with scrimshaw wildlife artwork **FEATURES** Brush finished back with Browning logo

MODEL	DESCRIPTION	BLADE LENGTH	CODE #	SUGG. RETAIL
540	Scrimshaw Whitetail	2 ⁷ / ₈ "	322540	\$59.95
541	Scrimshaw Mule Deer	2 ⁷ / ₈ "	322541	59.95
542	Scrimshaw Elk	2 ⁷ / ₈ "	322542	59.95
543	Scrimshaw Mallard	2 ⁷ / ₈ "	322543	59.95
544	Scrimshaw Pheasant	2 ⁷ / ₈ "	322544	59.95
545	Scrimshaw Turkey	2 ⁷ / ₈ "	322545	59.95
547	Scrimshaw Lab	2 ⁷ / ₈ "	322547	59.95



TAKE CARE OF YOUR GAME.

The Game Reaper is a combination bone saw and guthook, giving you a versatile, two-in-one tool that makes quick work of gutting and field dressing any big game animal. The T-shaped handle with machined grooves gives you a sure grip with better control so the blade is less likely to slip. It's lightweight and easy to pack. When your game is down, get to work with your Game Reaper.

GAME REAPER T-HANDLE SAW

TYPE Two-in-one T-Handle pelvic saw and guthook

MODEL	DESCRIPTION	BLADE LENGTH	CODE #	SUGG. RETAIL
NEW 926	Game Reaper Saw, Black	3 ³ / ₄ "	322926	\$19.95
NEW 927	Game Reaper Saw, MOINF	3 ³ / ₄ "	322927	24.95



T-Handle Saw comes with a durable nylon belt sheath

THE ULTIMATE HUNTING SET.

Years of extensive field research have culminated with the ultimate three-piece hunting set, the Hard Core Hunter. Demanding hunters are sure to appreciate the hand saw with its 4¾" long high carbon steel push/pull blade that makes fast work of wood or game. The custom T-handle shape minimizes hand fatigue. The knife has a drop point main blade and a unique canoe-shape handle with Dura-Touch® Armor Coating for complete comfort and control. A small caping knife offers precision for delicate field chores from caping a hide to peeling an apple. All blades fit into a slim, one-of-a-kind compact carry system with a unique swivel belt clip that makes both the saw and knives easily accessible.



437 Black Combo

★ *Designed in the USA by Russ Kommer*



438 Mossy Oak®
New Break-Up® Combo

MODEL	DESCRIPTION	BLADE LENGTH	CODE #	SUGG. RETAIL
437	Hard Core Hunter Combo, Black	Drop Point: 3½" Caper: 2¾" Saw: 4¾"	322437	\$79.95
438	Hard Core Hunter Combo, MONBU	Drop Point: 3½" Caper: 2¾" Saw: 4¾"	322438	89.95

HARD CORE HUNTER COMBOS

TYPE Fixed blades **BLADES** German X50CrMoV15 steel
HANDLES Contour molded composite **FEATURES** Nylon sheath that easily fits all three items



Straight from the demands of hunters comes the Guide's Choice knives. These sleek pairs are constructed from tough Sandvik® 12C27 stainless steel. The modified drop point style blade of the larger knife is ideal for general field dressing, while the smaller caping knife makes skinning easier and more precise than ever. Full-length tangs afford impeccable balance and strength. Canoe-shaped handles with finger grooves give ample grip. When a single knife just won't do the job, reach for the Guide's Choice combo.



Nylon sheath included with Model 521.



MODEL	DESCRIPTION	BLADE LENGTH	CODE #	SUGG. RETAIL
521	Guide's Choice, Fixed Blade, G-10	3½" 2¾"	322521	\$49.95
523	Guide's Choice, Fixed Blade, Stag	3½" 2¾"	322523	99.95

GUIDE'S CHOICE KNIVES

TYPE Fixed blades **BLADES** Swedish Sandvik® 12C27 stainless steel **HANDLES** Stag or G-10 **FEATURES** Stag handled fixed-blade models include a top-grain leather sheath • G-10 handled models include a Cordura® nylon sheath



Fixed-blade Escalade knives include a heavy duty, top-grain leather sheath.



ESCALADE SERIES KNIVES

TYPE Fixed blades **BLADES** Swedish Sandvik® 12C27 stainless steel

HANDLES USA box elder burl

FEATURES Includes a top-grain leather sheath

MODEL	DESCRIPTION	BLADE LENGTH	CODE #	SUGG. RETAIL
662	Escalade Series, Fixed Blade Skinner, Brown Box Elder Burl	2½"	322662	\$69.95
663	Escalade Series, Fixed Blade Drop Point, Gray Box Elder Burl	3½"	322663	79.95
664	Escalade Series, Fixed Blade Drop Point, Brown Box Elder Burl	3¾"	322664	79.95

With just a little practice and a sharp, quality Browning Outdoorsman Fillet knife, you can lay out some very impressive and tasty fillets in minutes. They are made to easily cut fillets with veteran-like ease. The razor-sharp German X50CrMoV15 steel blade provides just the

amount of flex and feedback needed to glide over bones and carve perfect fillets every time. Tough, full tang canoe-shaped molded handles provide a secure non-slip grip even when wet, for added control and comfort.



OUTDOORSMAN FILLET KNIVES

TYPE Fixed blade fillet **BLADES** German X50CrMoV15 steel **HANDLES** Durable injection molded handles with inlaid metal Buckmark **FEATURES** Nylon sheath included

MODEL	DESCRIPTION	BLADE LENGTH	CODE #	SUGG. RETAIL
483	Outdoorsman Fillet, Black	7¼"	322483	\$29.95
484	Outdoorsman Fillet, Yellow	7¼"	322484	29.95

Incredibly versatile, the Woodsman Bird and Trout fixed blade knives and new Dirty Bird and Trout folding models are ideal for wingshooters and fishermen alike. Their unique blade shapes offer superb balance and ease of handling that enables intricate cuts in tight places like wing joints. Fixed blade models have either a resin-impregnated linen handle with mirror-polished blade and

bolsters, or a utilitarian Mossy Oak® Duck Blind® handle. The Woodsman models have 12C27 stainless steel blades and the Dirty Bird and Trout blades are 440 stainless steel. The folders feature a folding liner lock with 440 stainless steel blades. Select a black G-10 handle or aluminum covered in Mossy Oak® Duck Blind® camo. Both have handy pocket clips.



MODEL	DESCRIPTION	BLADE LENGTH	CODE #	SUGG. RETAIL
326	Woodsman Bird and Trout, Black Laminate	3½"	322326	\$79.95
327	Woodsman Bird and Trout, MODB Laminate	3½"	322327	59.95
NEW 338	Dirty Bird and Trout, Folding, Black	3½"	322338	24.95
NEW 339	Dirty Bird and Trout, Folding, MODB	3½"	322339	29.95

WOODSMAN BIRD AND TROUT KNIVES

TYPE Fixed blade **BLADES** Swedish Sandvik® 12C27 stainless steel **HANDLES** 326: Black laminate • 327: MODB camo laminate **FEATURES** 326: Top-grain leather sheath • 327: Ballistic Cloth™ nylon sheath

DIRTY BIRD AND TROUT FOLDERS

TYPE Folding liner lock **BLADES** 440 stainless steel **HANDLES** 338: Black G-10 • 339: MODB camo aluminum handle **FEATURES** Pocket clip

PRECISION AND BEAUTY

Knives similar to the Classic Series first appeared way back in the 1969 Browning catalog. Today's Classic Series knives have all the features that made the original models so prized, and more. Razor sharp blades are fancy scroll etched and embellished with a gold Buckmark. Precision construction means the blade locks open with a snap. These folding models are thin and hardly noticed in a pocket or purse, and make excellent gifts. Select from a variety of handle materials including stainless, wood, stag or mother-of-pearl scales.



366



367



368



334



335



336



337

MODEL	DESCRIPTION	BLADE LENGTH	CODE #	SUGG. RETAIL
366	Stainless, Medium Folder	2 $\frac{5}{8}$ "	322366	\$19.95
367	Wood, Medium Folder	2 $\frac{5}{8}$ "	322367	19.95
368	Stag, Medium Folder	2 $\frac{5}{8}$ "	322368	29.95
334	Stainless, Small Folder	1 $\frac{3}{4}$ "	322334	14.95
335	Wood, Small Folder	1 $\frac{3}{4}$ "	322335	14.95
336	Stag, Small Folder	1 $\frac{3}{4}$ "	322336	24.95
337	Mother-of-Pearl, Small Folder	1 $\frac{3}{4}$ "	322337	24.95

CLASSIC SERIES KNIVES

TYPE Folding lockbacks

BLADES 5CR15MOV stainless steel with engraving

HANDLES Stainless, Wood, Stag or Mother-of-Pearl

FEATURES Ultra-thin construction slides easily into pocket without adding excess bulk • Unique blade etching with Buckmark sets these knives apart

A TRADITION OF QUALITY

The warm feel of real stag or a hardwood handle on a fine knife is assurance that you have a quality, well-built tool. One of these Big Game Hunting knives will be all the knife you need to deal with any chore. Their canoe-shape and finger grooves give you precise maneuverability. The 440 stainless steel drop point blades are razor-sharp. Stag model has high-polished stainless bolster with finger guard and lasered Buckmarks. The Stag model has a leather tie. Leather sheaths are included with both knives.

NEW

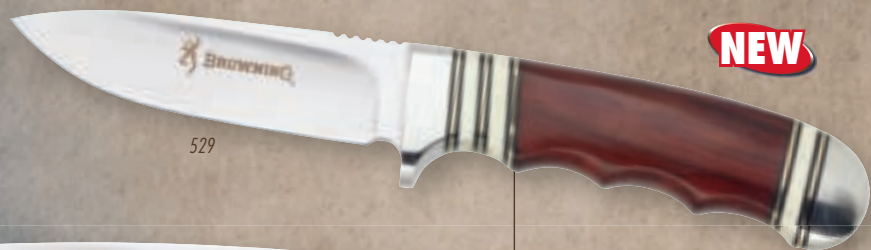

529



525

COCOBOLO/BONE BIG GAME HUNTING KNIFE

TYPE Hidden tang fixed blade **BLADE** 12C27 stainless steel **HANDLE** Cocobolo with bone accents **FEATURES** Includes a top-grain leather sheath

STAG BIG GAME HUNTING KNIFE

TYPE Full tang fixed blade **BLADE** 440 stainless steel **HANDLE** Stag **FEATURES** Includes a top-grain leather sheath

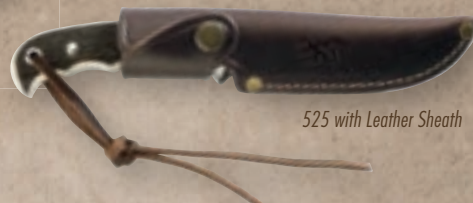

525 with Leather Sheath

MODEL	DESCRIPTION	BLADE LENGTH	CODE #	SUGG. RETAIL
NEW 529	Cocobolo/Bone, Fixed Blade	3¾"	322529	\$49.95
525	Stag, Fixed Blade	4¼"	322525	119.95

FEATHERWEIGHT KNIFE

TYPE Folding lockback **BLADES** AUS-8A stainless steel • Versatile push/pull hide-cutter blade • Serrated saw blade **HANDLES** Zytel® with laminated wood inserts • 524: Stag scales and brass bolsters **FEATURES** Ballistic Cloth™ nylon sheath

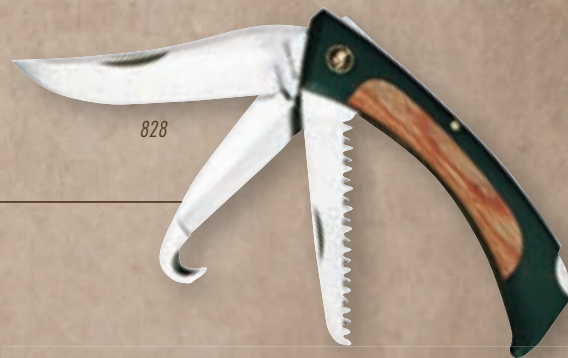

828

MODEL	DESCRIPTION	BLADE LENGTH	CODE #	SUGG. RETAIL
828	Featherweight Big Game II	3¼"	322828	\$89.95

The Tactical Hunter Series knives offer a unique addition to every outdoorsman's arsenal. Precision crafted, these high-quality knives feature a unique flipper design that assists in the speedy opening of the knife. It also doubles as a finger guard when the blade is extended. The VG-10 stainless steel drop point blade is of the highest quality and holds an incredible edge. Corrosion-resistant titanium bolsters and liners are durable and light weight. The attached pocket clip keeps the knife secure and easy to locate.

TACTICAL HUNTER SERIES KNIVES

TYPE Folding liner lock with flipper and stainless steel thumbstud **BLADES** Japanese VG-10 stainless steel **HANDLES** 503: 6061 aircraft-grade aluminum with Mossy Oak® Break-Up Infinity® camo • 504: Black G-10 **FEATURES** Pocket clip



503

504

MODEL	DESCRIPTION	BLADE LENGTH	CODE #	SUGG. RETAIL
503	Tactical Hunter, MOINF	3¾"	322503	\$59.95
504	Tactical Hunter, Black G-10	3¾"	322504	\$9.95



465



466



467



468

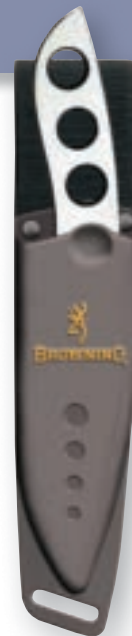

466
With Molded Sheath

★ Designed in the USA by Russ Kommer



EXTREME MOUNTAIN HUNTER KNIVES

TYPE Fixed blade extreme **BLADES** Teflon® coated Sandvik® 12C27 stainless steel
HANDLES Stainless steel skeleton frame
FEATURES Injection molded quick-release sheath with Ballistic Cloth® nylon backing

Extreme Mountain Hunter knives are designed for performance and reliability in extreme conditions and circumstances. Each knife is built from a single piece of tough Sandvik® 12C27 stainless steel with a Rockwell hardness of 58RC-59RC for the razor-sharp, edge-holding ability hunters demand. A lightweight, injection molded sheath that complements the knives' rugged, no-nonsense construction is included. If you push yourself and your gear to the limit, an Extreme Mountain Hunter is your knife.

MODEL	DESCRIPTION	BLADE LENGTH	CODE #	SUGG. RETAIL
465	Large Drop Point	2¾"	322465	\$49.95
466	Medium Drop Point	2½"	322466	49.95
467	Modified Drop Point	2½"	322467	49.95
468	Semi-Skinner	2½"	322468	49.95



716

715

717

SPUR NECK KNIVES

TYPE Curved fixed blade
BLADES 440 stainless steel
HANDLES Rugged black G-10
 • Aluminum with Dura-Touch® coating on camo **FEATURES** Hangs on safety breakaway neck chain
 • Locks securely in Kydex® sheath

This unique knife, designed by Russ Kommer, was inspired while hunting pheasants in North Dakota. Unloading his game bag, he couldn't help notice the rooster's spurs — sharp and curved — and a natural defensive fighting weapon. Useful for caping, fishing and certainly for everyday carry, one of nature's best defenses becomes a handy tool in your hand.

MODEL	DESCRIPTION	BLADE LENGTH	CODE #	SUGG. RETAIL
NEW 715	Spur Neck Knife, Black	1¾"	322715	\$14.95
NEW 716	Spur Neck Knife, MOBU	1¾"	322716	19.95
NEW 717	Spur Neck Knife, MO Pink	1¾"	322717	19.95



Includes Kydex® sheath with neck chain



790



792



794



Logo detail

LIL' BIT KNIVES

TYPE Fixed blade and folding lockback

BLADES Sandvik® 12C27 stainless steel

HANDLES Genuine stag

FEATURES Top grain leather sheath included • Leather tie

Don't be fooled by the name, these knives are big on performance. Lil' Bit Series knives are a tried and true drop point blade design made from Swedish Sandvik® 12C27 stainless steel that is renowned for superior edge holding ability. Ideally balanced to minimize hand fatigue, Lil' Bit knives are available with genuine stag handles, and come with a top grain leather tie and sheath (fixed blade sheath shown at right.)

MODEL	DESCRIPTION	BLADE LENGTH	CODE #	SUGG. RETAIL
790	Lil' Bit Stag, Small	2¼"	322790	\$49.95
792	Lil' Bit Stag, Large	3¼"	322792	59.95
794	Lil' Bit Stag, Folder	2⅞"	322794	44.95



Fixed Blade
Leather Sheath

packer SERIES

Designed by experienced guide and imaginative knifemaker Russ Kommer, Packer Series knives were conceived on the unforgiving frontiers of Alaska. The unique handle design and blade shapes maximize the cut efficiency and reduce wrist fatigue. Packers come in three different blade designs: A multi-use modified drop point, a big belly semi-skinner and a modified

drop point with a guthook. The knives feature genuine stag handles and a beautiful leather sheath. We have also teamed up with the Rocky Mountain Elk Foundation to offer knives with highly figured burl wood handles and a laser engraved RMEF logo on the bolsters, along with a nylon sheath.



PACKER SERIES KNIVES

TYPE Fixed blade **BLADES** Sandvik® 12C27 stainless steel **HANDLES** Genuine stag or highly grained burl wood **FEATURES** Top-grain sheath included with stag models • Nylon sheath included with RMEF models

MODEL	DESCRIPTION	BLADE LENGTH	CODE #	SUGG. RETAIL
783	Packer Stag	2 ⁷ / ₈ "	322783	\$69.95
784	Packer Stag, Semi-Skinner	3 ¹ / ₈ "	322784	69.95
785	Packer Stag with Guthook	3 ¹ / ₈ "	322785	69.95
780	Packer RMEF, Burl Wood	2 ⁷ / ₈ "	322780	39.95
781	Packer RMEF, Burl Wood Semi-Skinner	3 ¹ / ₈ "	322781	39.95
782	Packer RMEF, Burl Wood with Guthook	3 ¹ / ₈ "	322782	39.95



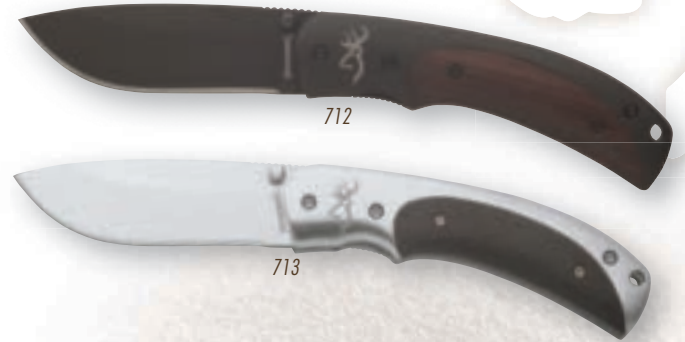
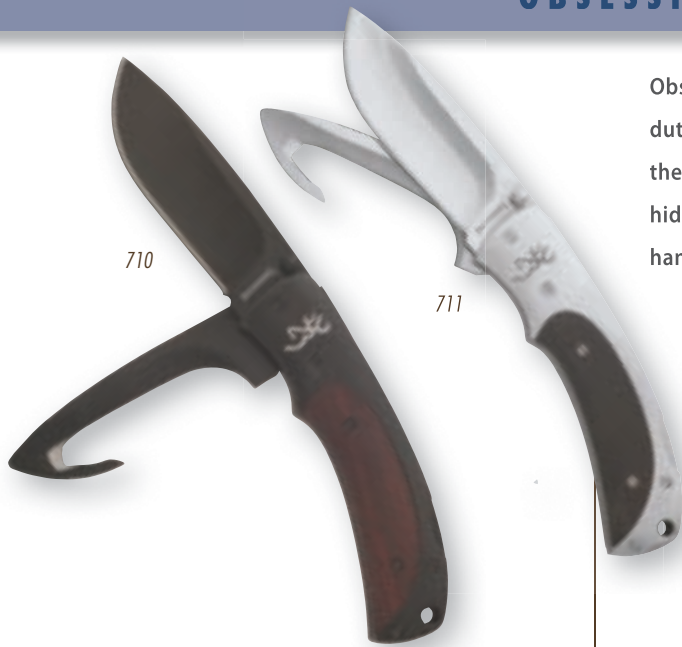

Obsession knives give hunters the perfect tool for dressing and skinning duties. The main blade is a drop point design, and twin-blade models include the best guthook blade ever. The guthook's long throat efficiently funnels the hide without puncturing the rumen, and in the closed position, fits inside the handle for comfort and safety.

OBSESSION SERIES KNIVES

TYPE Folding lockback **BLADES** Sandvik® 12C27 stainless steel **HANDLES** Stainless steel with G-10 or wood inserts
FEATURES Nylon sheath included with two blade models
 • Pocket clip with single blade models

MODEL	DESCRIPTION	BLADE LENGTH	CODE #	SUGG. RETAIL
710	Obsession 2-Blade, Wood	3¼"	322710	\$39.95
711	Obsession 2-Blade, G-10	3¼"	322711	39.95
712	Obsession 1-Blade, Wood	3¼"	322712	29.95
713	Obsession 1-Blade, G-10	3¼"	322713	29.95

KODIAK KNIVES. STILL THE TOUGHEST AND NOW EVEN MORE VERSATILE.

We've improved our popular Kodiak series knives by tucking away the guthook inside the frame, keeping it out of the way when using the main blade. The guthook now has a larger throat to keep the hide from bunching up for cleaner cutting. The three-blade model has a push/pull saw that cuts with each stroke to make field dressing a simple task. These knives incorporate two different locking systems — a button liner lock and a lock-back — to lock all the blades more securely. All Kodiak models come with a handy nylon sheath that can be worn in either the horizontal or vertical position.



KODIAK F.D.T.™ KNIVES (FIELD DRESSING TOOLS)

TYPE Folding lockback and lockback/button lock combination **BLADES** 440 stainless steel
HANDLES Aluminum **FEATURES** Ballistic Cloth™ nylon sheath included (not shown)

MODEL	DESCRIPTION	BLADE LENGTH	CODE #	UNIQUE FEATURES	SUGG. RETAIL
NEW 627	Kodiak F.D.T., Single Blade	3½"	322627	Lockback design with single blade	\$19.95
NEW 628	Kodiak F.D.T., Two Blade	3½" Main blade	322628	Drop point blade has lockback design; guthook has a button lock	29.95
NEW 629	Kodiak F.D.T., Three Blade	3½" Main blade	322629	Drop point center blade has lockback design; guthook and saw have a button lock	39.95

THE BUCK STOPS HERE!

Designed by Russ Kommer, the Browning 111 lockbacks improve upon a popular folding design with a finger-grooved, canoe handle constructed from rugged G-10 or cocobolo wood. Hefty bolsters add to the beauty and balance. Modern materials and design ensure the Model 111 knives are one up on the competition.

BROWNING 111 FOLDING KNIVES

TYPE Folding lockback **BLADES** Sandvik® 12C27 stainless steel **HANDLES** 111C: Cocobolo scales and white brass bolsters • 111D: G-10 scales and stainless bolsters **FEATURES** Nylon sheath included (not shown) • Spine is stamped "Morgan, Utah"



MODEL	DESCRIPTION	BLADE LENGTH	CODE #	SUGG. RETAIL
111C	Cocobolo	3 3/4"	322111C	\$39.95
111D	Black G-10	3 3/4"	322111D	34.95

Versatile, compact and rugged, Backtrack Folders feature a stainless steel clip point blade and handles that are engraved with the tracks of popular game animals.

BACKTRACK FOLDERS

TYPE Folding lockback **BLADES** 7CR stainless steel **HANDLES** Stainless steel with game track engraving **FEATURES** Ultra-thin construction slides easily into pocket without adding excess bulk



MODEL	DESCRIPTION	BLADE LENGTH	CODE #	SUGG. RETAIL
533	Deer	3"	322533	\$19.95
534	Bear	3"	322534	19.95
535	Turkey	3"	322535	19.95
536	RMEF Elk	3"	322536	19.95





LOOK SHARP.

Convenient to take along nearly everywhere, lightweight Prism II folders open easily with one hand to reveal a razor-sharp straight edge blade. Colorful anodized handles with laser-cut Buckmarks make these knives look as sharp as their blades.

PRISM II KNIVES

TYPE Folding frame lock **BLADES** 440-A stainless steel
HANDLES Anodized machined aluminum • Stainless steel bolsters **FEATURES** Pocket clip • Thumbstud

MODEL	DESCRIPTION	BLADE LENGTH	CODE #	SUGG. RETAIL
5622	Prism II, Pink	2½"	3225622	\$14.95
5632	Prism II, Orange	2½"	3225632	14.95
5642	Prism II, Blue	2½"	3225642	14.95
5652	Prism II, Green	2½"	3225652	14.95
5662	Prism II, Black	2½"	3225662	14.95
5672	Prism II, MOINF	2½"	3225672	14.95



Lightweight and rugged, Mountain Ti knives feature a razor-sharp, highly versatile drop-point style folding blade design. The contrasting finish on the stainless steel handles is striking, while the titanium-coating on the blade gives corrosion resistance. A pocket clip keeps the knife at the ready and easy one-hand opening quickly puts the knife into action. The frame lock offers excellent security.

MODEL	DESCRIPTION	BLADE LENGTH	CODE #	SUGG. RETAIL
560	Mountain Ti, Medium	3"	322560	\$24.95
561	Mountain Ti, Small	2¼"	322561	19.95



MOUNTAIN TI KNIVES

TYPE Folding frame lock **BLADES** 440-A stainless steel • Titanium coated
HANDLES Two-tone gray machined 420J1 stainless • Titanium coated **FEATURES** Pocket clip • Ambidextrous thumbstud

A solid knife can take care of the chores of several tools. Whether it's preparing kindling for a fire, clearing a shooting lane, cleaning a trout or dressing out a deer, our Backcountry Series knives are the best all-around blades for any job. With full-length tapered tangs for maximum balance and tough canoe-shaped resin-laminated canvas handles, you'll have a head start on the toughest outdoor jobs. Browning Backcountry knives are as close to being custom as you'll ever find in a production knife. Leather sheath included.



Leather Sheath with Sharpening Stone

BACKCOUNTRY SERIES KNIVES

TYPE Fixed blade **BLADES** Sandvik® 12C27 stainless steel **HANDLE** Brown resin-laminated canvas
FEATURES Top-grain leather sheath • Sharpening stone included with Camp Knife

MODEL	DESCRIPTION	BLADE LENGTH	CODE #	SUGG. RETAIL
976	Backcountry Hunting Knife	4¼"	322976	\$89.95
975	Backcountry Camp Knife	6¼"	322975	109.95



James Crowell

This unique knife is a joint design effort between James Crowell and Reggie Barker, the only two men to have won an American Bladesmith Society (ABS) World Cutting Championship. Jim Crowell is well known in the knife industry and the first to win the ABS World Championship. Reggie Barker is known as "The Sharpest Man in Texas," and won the ABS World Champion title for the third time at the 2007 BLADE Show. He's also won the 2004 and 2005 ABS World Championship Cutting Competition. The Browning Crowell/Barker Competition knife includes a top-grain leather sheath and a Certificate of Authenticity, signed by both Jim Crowell and Reggie Barker.



Reggie Barker



This knife is approved for select International Cutting Competition Trail (ICCT) events. To learn more about this exciting action sport, visit cuttingcompetition.com.

CROWELL/BARKER COMPETITION KNIFE

TYPE Fixed blade competition
BLADE Heavy drop point, made from high-carbon steel with a .142 satin finish
 • Laser-etched on one side
HANDLE Resin-laminated canvas with three rivets and wrist lanyard
FEATURES Custom-made top-grain leather sheath

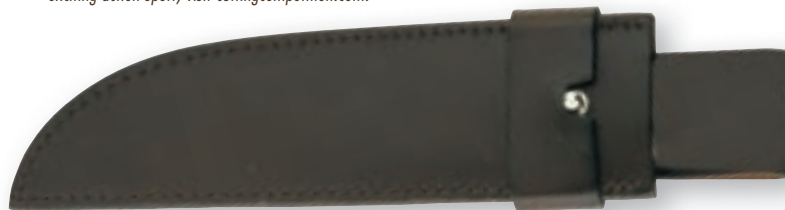

Removable Sheath



MODEL	DESCRIPTION	BLADE LENGTH	CODE #	SUGG. RETAIL
580	Crowell/Barker Comp.	10"	322580	\$149.95

Master Bladesmiths are trained professionals. Caution should be heeded when using sharp objects. Browning assumes no responsibility for misuse of its products.

GUNSTOCK SERIES KNIVES

TYPE Folding pocket knives **BLADES** 440 stainless steel **HANDLES** Jigged bone **FEATURES** Polished bolsters



Sized to fit in your pocket, Gunstock Series knives are reminiscent of those classics owned by your Dad or Grandpa. Jigged bone scales are checkered to resemble your favorite Browning firearm. Satin finished bolsters and edge-holding 440 stainless steel blades give Gunstock knives a vintage edge.

MODEL	DESCRIPTION	BLADE LENGTH	CODE #	SUGG. RETAIL
875	Gunstock, One Blade	2¾"	322875	\$19.95
876	Gunstock, Two Blade	2¾"	322876	19.95
877	Gunstock, Two Blade/Scissors	2½"	322877	19.95

Pocket knives are called upon to handle a load of different jobs, but above all a pocket knife must be convenient. Fast Task knives are ready to work with flipper-assisted openings that make opening the blade a simple flip of the wrist.

FAST TASK SERIES KNIVES

TYPE Folding pocket knives with flipper-assisted opening **BLADES** 440 stainless steel **HANDLE** G-10 or rosewood **FEATURES** Stainless bolsters



MODEL	DESCRIPTION	BLADE LENGTH	CODE #	SUGG. RETAIL
771	Fast Task, Black G-10	2¾"	322771	\$14.95
772	Fast Task, Green G-10	2¾"	322772	14.95
773	Fast Task, Rosewood	2¾"	322773	14.95

Our Presentation Lockback knives make the perfect gift. Select either durable stainless steel or aluminum handles, and the Buckmark logo or animal scenes. All feature a high-quality stainless steel blade, excellent fit and finish. Every outdoorsman (and everyone who aspires to be an outdoorsman) will find a Presentation Lockback an essential part of their everyday pocket equipment.



All Presentation Lockback knives come in a presentation case.

MODEL	DESCRIPTION	BLADE LENGTH	CODE #	SUGG. RETAIL
NEW 808	Deer, Lockback	2½"	322808	\$49.95
NEW 809	Elk, Lockback	2½"	322809	49.95
NEW 810	Goose, Lockback	2½"	322810	49.95
NEW 811	Turkey, Lockback	2½"	322811	49.95
NEW 812	Buckmark, Lockback	2½"	322812	49.95

PRESENTATION LOCKBACK KNIVES

TYPE Folding lockback **BLADES** 420 stainless steel **HANDLES** Stainless steel (aluminum on Model 812) **FEATURES** Presentation case

wingman AND SAGEBRUSH KNIVES

A sharp, liner lock-blade knife is one of the handiest tools you can carry. And because they fold up, you can slip them away in your pocket. The new Wingman knives look good as well, with your choice of burl wood, cocobolo or rugged

G-10 handles. Satin stainless steel bolsters match well with the satin stainless steel blades. The 2½" blade will let you whittle away all day long on a variety of projects. Carry one during your busy day and see how much you rely on it.



WINGMAN KNIVES

TYPE Folding liner lock **BLADES** Satin stainless steel

HANDLES 427: Burl wood with stainless steel bolsters

• 428: Cocobolo with stainless steel bolsters

• 429: G-10 with stainless steel bolsters

FEATURES Pocket clip • Sharp, compact with liner-locks

MODEL	DESCRIPTION	BLADE LENGTH	CODE #	SUGG. RETAIL
NEW 427	Burl Wood	2½"	322427	\$14.95
NEW 428	Cocobolo	2½"	322428	14.95
NEW 429	G-10	2½"	322429	14.95



Slender enough to carry all day without becoming a burden in your pocket and elegant enough to turn heads every time you open it, a Sagebrush knife is the ideal tool to have when you need a sharp blade.

SAGEBRUSH KNIVES

TYPE Folding lockback **BLADES** Satin stainless steel **HANDLES** Stainless

steel with scrollwork or highly figured burl wood **FEATURES** Pocket clip

• Sculpted thumbstud • Tapered shape

MODEL	DESCRIPTION	BLADE LENGTH	CODE #	SUGG. RETAIL
NEW 269	Stainless	3"	322269	\$69.95
NEW 212	G-10	3"	322212	69.95

Nothing is used more in the kitchen than a good set of sharp knives. Kitchen knives must be durable, have a variety of blade shapes for specific tasks and remain sharp, especially when used for processing wild game. The 14-piece Outdoorsman Kitchen Cutlery set has everything necessary for the home or cabin, including a hollow-ground boning knife that holds a razor edge, game shears and a sharpening steel. The set also includes standard kitchen cutlery and a uniquely designed carving fork with a pigtail twist so it won't bend when lifting a 10-pound roast from the pan. The set has a standard chef's knife with an innovative scalloped blade to reduce friction for carving meat, and six elegant steak knives for table use. Another favorite will be the bread knife, with large serrations, to make slicing warm homemade bread easy. The knives are made from quality German steel with full tangs to ensure the Outdoorsman Set will last. Metal Browning Buckmarks are set in the durable injection molded handles.

OUTDOORSMAN STEAK KNIVES AND KITCHEN CUTLERY SET

TYPE Steak knives/Kitchen cutlery
BLADES German X50CrMoV15 steel
HANDLES Durable injection molded handles with inlaid metal Buckmark
FEATURES 480: Black wood block
 • 480C: Bamboo block



480C



480



481



MODEL	DESCRIPTION	BLADE LENGTH	CODE #	SUGG. RETAIL
480C	Kitchen Cutlery Set, Bamboo Block	N/A	322480C	\$324.95
480	Kitchen Cutlery Set, Black Block	N/A	322480	324.95
481	Six Steak Knife Set, Black Block	4 1/4"	322481	139.95

Versatile, rugged and razor sharp, knives are designed to be clipped to a pocket or belt so they are always at the ready. The handle shape comfortably fits in your hand and the contrasting finish on the handle and bolster offers lasting good looks. The liner lock adds excellent security and is easy to operate with your thumb.

CROSSFOX

TYPE Folding liner lock **BLADES** 440 stainless steel **HANDLES** Aluminum with Mossy Oak® Break-Up Infinity® or rugged G-10 **FEATURES** Pocket clip
 • Thumbstud • Titanium coated bolsters accent blade and handle material
 • Available only from Browning Full Line and Medallion Dealers

MODEL	DESCRIPTION	BLADE LENGTH	CODE #	SUGG. RETAIL
NEW 209	Black	2 7/8"	322209	\$19.95
NEW 210	MOINF	2 7/8"	322210	24.95



209

210





WHEN THE CHUCKWAGON'S TRIANGLE RINGS...

You'll be glad you packed along the Campmate knife and one of our sharp Camp Saws on your next hunting or camping trip. They are so compact and easy to carry, you may forget about them until meal time rolls around and you unfold your Campmate. It carries a sharp blade, a spoon and a fork so you can help prepare a fine meal with it, then chow down with the rest of the gang.



970

CAMPMATE KNIFE

TYPE Folding with liner lock knife **BLADES** 440 stainless steel **HANDLES** Injection-molded composite **FEATURES** Nylon sheath included

MODEL	DESCRIPTION	CODE #	SUGG. RETAIL
970	Campmate Knife, Black	322970	\$19.95



922

924



923



925

No folding saw can match a Browning. The canoe-shaped rubber handle has finger grooves and a large tail radius to ensure a rock solid grip and fatigue-free comfort in your hand. The high-carbon stainless steel push/pull blade maximizes cutting efficiency on wood and when dressing game. The button lock securely locks the blade in both the open and closed position. Wear the unique sheath in either a horizontal or vertical position. Compact, lightweight and durable, this saw is the ultimate at a price that can't be beat. Camp Saw Combos include a folding knife with a secure liner lock and thumbstud.

CAMP SAWS

TYPE Folding saw and folding saw/knife combo **BLADES** 4116 stainless steel saw • 7CR stainless steel knife **HANDLES** Saw: Injection molded composite with rubber inlay • Knife: Anodized aluminum **FEATURES** Nylon sheath included with saw • Knife includes pocket clip

MODEL	DESCRIPTION	CODE #	SUGG. RETAIL
922	Camp Saw (5¼" Blade), Black	322922	\$19.95
923	Camp Saw (5¼" Blade) and Knife (3½" Blade), Black	322923	29.95
924	Camp Saw (5¼" Blade), MONBU	322924	29.95
925	Camp Saw (5¼" Blade) and Knife (3½" Blade), MONBU	322925	39.95

Here are three tools you can't be without when camping or doing chores around the yard. Our new Outdoorsman's Axe is specially designed to reduce hand fatigue, shock and to take more wood with each swing without binding. It's perfect for making kindling or quartering big game. Grab our new Outdoorsman's Shears and use them to clear a

shooting lane or for butchering big game, easily cutting through briskets, bone, legs and ribs, making field dressing a cinch. Pull our new diamond-coated Field Sharpening Steel from your pocket and keep an edge on any blade. It has a stainless steel handle and guard and a durable nylon sheath.

OUTDOORSMAN'S AXE

TYPE Axe **BLADE** One-piece head is hot-forged, hollow ground, high carbon 1055 tool steel • Integrated tang extends down into handle **HANDLE** Injection-molded polypropylene and fiberglass, lightly textured • Overall length 23¾" • Weight 2 lbs. 6 oz. **FEATURES** Handle is shaped for easy hand placement when cutting smaller pieces • Sheath included



Includes tough nylon sheath with snap and Buckmark logo

OUTDOORSMAN'S SHEARS

TYPE Shears **BLADES** High carbon tool steel **HANDLES** Tough polypropylene and rubber • Telescopes from 21" to 28" **FEATURES** Lower blade is serrated on one edge • Large guthook for severing pieces of hanging tissue • Sheath included



Includes tough nylon sheath with snap and Buckmark logo



Overall collapsed length is only 21" and weight is 2.14 lbs.



FIELD STEEL

TYPE Sharpening steel **HANDLE** Knurled for a sure grip **FEATURES** Two-piece steel reverses for use and storage • Stores compactly in its own sheath with belt loop

MODEL	DESCRIPTION	CODE #	SUGG. RETAIL
NEW 231	Outdoorsman's Axe	322231	\$59.95
NEW 230	Shears	322230	39.95
NEW 567	Field Steel Sharpener	322567	19.95

HOW TO CHOOSE A FLASHLIGHT

We are a leading manufacturer of portable battery-powered lighting for hunters and shooters. With more than 50 styles in our product line, how do you choose the light that best meets your needs? Read on.

SIZE, WEIGHT AND POWER

Smaller and lighter are better. New high-output LEDs from manufacturers like Luxeon® and Cree® are incredibly powerful and efficient, and don't require the size and weight of the old C and D battery lights to achieve the same light output. Our Alpha and Alpha Max flashlights, with a single AA battery, are brighter than the flashlights of the past and are no bigger than a shotgun shell.

LED VS. XENON BULBS

LEDs are preferred over Xenon and other types of filament bulbs for most uses. LEDs use batteries more efficiently, illuminate at equal or greater distance, emit a clean white versus a dull yellow beam and will not burn out under normal use. And the newest LEDs, like computer chips, get better every year. Watch for upgrades of 20% - 80% or more in brightness in many of our lights for 2012.

HAND-HELD OR HANDS-FREE

Headlamps and cap lights allow the use of both hands for other tasks like dressing a deer, fixing the truck or finding a path through the woods. With modern technology many headlamps are as powerful as larger hand-held flashlights. Several headlamps, such as MicroBlast and Phantom can be worn either as a headlamp or clipped to the brim of a hat.

LONG RUN TIME

Using digital circuitry, highly-efficient LEDs, and new types of low-resistance switches, we are now able to offer extra long run time on many lights. Most Tactical Hunter lights will run for 20-60 hours on the low setting, even on a single AA battery — which might be the difference between getting home and waiting until morning to hike out.

BATTERIES

Lithium batteries are used in many of our highest-performing lights, such as Catalyst, Hunt Master and Nitro. Lithium batteries pack about twice the power of alkaline batteries for their weight, and operate at very cold temperatures. Convenient AA and AAA alkaline batteries are also used extensively because they cost less than lithium and are more readily available. The latest integrated circuit designs in our Hi Power, Pro Hunter, Zeta and Alpha flashlights boost the performance of alkaline batteries to approach the performance of lithium batteries.

SWITCH SETTINGS

Multiple switch settings (high, low and in-between) preserve battery life and allow selecting between colors and flashing options. Lock-out switches found on most of our lights keep the light from accidentally turning on.

RED, GREEN AND BLUE

Colored LEDs help preserve your night vision and are great for map reading. They are less obvious than white light to many types of game animals.



BROWNING ADOPTS ANSI FL-1 PERFORMANCE STANDARDS

Beginning in 2010, the major flashlight manufacturers agreed to use the same standards (ANSI-FL1) for measuring performance, so you can make an apples-to-apples comparison between models. We are proud to endorse and participate in these standards for portable lighting.*



Lumens = Brightness.

A traditional 2D cell flashlight is approximately 15 - 20 lumens.



Battery Life (Run Time) is defined as the time elapsed from when the batteries are new to when the light reaches 10% of the original brightness.



Maximum Distance is measured as the distance in meters from the light source to where it decreases in brightness to 0.25 lux — about the brightness of the full moon on a clear night.

* For Browning lights with multiple settings, the Lumens, Battery Life and Distance are stated at the highest setting (100% power), unless indicated otherwise.

TACTICAL HUNTER CONTROL POINT FLASHLIGHTS

• All-aluminum construction and O-ring sealed for water resistance • Advanced digital circuitry delivers maximum power • Rugged Tactical Hunter design with lock-out switch and Deep Pocket™ carry clip
LENGTH 5.6" **BRIGHTNESS** 210 lumens **EFFECTIVE DISTANCE** 190 meters

Control Point Rotating Selector Switch



3711240

NEW L.E.D.
 20% BRIGHTER

LONG RUN TIME
 UP TO **60h**



3711241

NEW L.E.D.
 20% BRIGHTER

LONG RUN TIME
 UP TO **60h**

DESCRIPTION	LED	CODE #	BATTERIES	BATTERY LIFE	LUMENS	SUGG. RETAIL
Tactical Hunter Control Point, Black	Luxeon Rebel	3711240	(2) CR123A Lithium	High: 4.5 hours Low: 60 hours	210	\$74.99
Tactical Hunter Control Point, MONBU with Dura-Touch® Armor Coating	Luxeon Rebel	3711241	(2) CR123A Lithium	High: 4.5 hours Low: 60 hours	210	84.99

CONTROL POINT

The Browning Control Point is as powerful as any two-battery light we've ever offered. This wonder combines the latest Luxeon® LED with a pair of 3V Lithium batteries and advanced electronics for a flashlight that outperforms all other flashlights in its class. In addition to tremendous light output and superior battery life, Control Point flashlights now offer five brightness levels to provide just the light you need (high [100%], medium-high [80%],

medium [60%], medium-low [35%], low [10 lumens]) and three flashing modes (fast strobe, normal strobe and S.O.S.). A rotating selector switch on the tailcap controls the electronics and a tactical, push button on/off switch on the end of the light makes it easy to turn the light on in a momentary function. Try a Control Point and see why this light outshines all the rest in the portable lighting market.

WHEN DARKNESS FALLS...

With great looks and the potential to squeeze every last drop of energy from a pair of common, easy-to-find AA alkaline batteries, our award winning Hi Power flashlights blend innovative technology with a striking appearance. The latest advancements in circuitry allow the AA-powered LED Hi Power to rival most lithium-powered lights for both lumen output and battery life. Protecting this leading-edge technology is a precision-machined aluminum housing, available with tough resin inlays or the same American walnut used for our firearms, set into the grip for a great new look. The side located, push-button switch is simple to use and includes a lock-out to keep the switch from accidentally turning on. One thing is for certain, when it comes to looks, convenience, battery life and sheer lumen output, the Hi Power flashlight is sure to be the first light you reach for.

HI POWER FLASHLIGHTS

- All-aluminum construction with walnut or black resin handle inlays
- Latest generation Cree® XP-E LED is rated for 50,000 hours use
- High-low electronic switch with lock-out • O-ring sealed for water resistance • Includes lanyard and two AA batteries **LENGTH** 5.25"

BRIGHTNESS 145 lumens **EFFECTIVE DISTANCE** 150 meters



3715303



3715304



3715301



3715305



DESCRIPTION	LED	CODE #	BATTERIES	BATTERY LIFE	LUMENS	SUGG. RETAIL
Hi Power, Gun Finish Matte Silver with American Walnut	Cree XP-E	3715303	(2) AA Alkaline	High: 1.5 hours; Low: 4.5 hours	145	\$74.99
Hi Power, Matte Finish Desert Metallic with Black Resin	Cree XP-E	3715304	(2) AA Alkaline	High: 1.5 hours; Low: 4.5 hours	145	74.99
Hi Power, Gun Finish Matte Black with American Walnut	Cree XP-E	3715301	(2) AA Alkaline	High: 1.5 hours; Low: 4.5 hours	145	74.99
Hi Power, Gun Finish Matte Black with American Walnut and RMEF logo	Cree XP-E	3715305	(2) AA Alkaline	High: 1.5 hours; Low: 4.5 hours	145	74.99

NITRO HEADLAMP

• Our brightest, most-powerful headlamp • Luxeon® Rebel LED shines 125 meters on high setting; plus two red and two green LEDs • Lock-out switch with settings for high and low • Unbreakable LEDs are rated for 100,000 hours use • CR123A battery operates to -40° F • Includes headstrap, or use with hat clip • Glass-fiber reinforced polycarbonate housing with aluminum lens ring • Silent Hinge™ for stealth **BRIGHTNESS** 135 lumens **EFFECTIVE DISTANCE** 125 meters



3718620

NEW L.E.D.
20% BRIGHTER

Martin Buser and his Happy Trails Kennels sled dog teams have won the grueling 1,161 mile Iditarod Trail Sled Dog Race an impressive four times. Their 1997 victory still holds the course record for the fastest finish time. Martin has relied on the Browning Nitro headlamp since 2008 to steer his team through the darkest Alaskan nights. "I am always searching for durable, unique products to give me an edge. The long-reaching, focused beam of the Nitro stretches past 80 feet of the sled team and makes finding trail markers easier. The lithium batteries are great because they last longer and are less affected by the cold than alkaline batteries."

— MARTIN BUSER



Side View

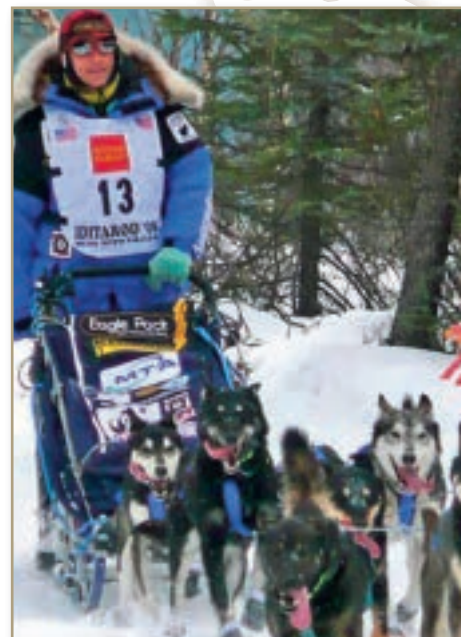

DESCRIPTION	LED	CODE #	BATTERIES	BATTERY LIFE	LUMENS	SUGG. RETAIL
Nitro Max Output Headlamp, MONBU	135 Lumen Luxeon Rebel + (2) Red, (2) Green	3718620	(1) CR123A Lithium	High: 3 hours; Low: 20 hours; Red, Green LEDs: 48 hours	135	\$54.99

Today's powerful Browning Tactical Hunter flashlights offer stronger illumination with innovative LED bulbs that provide more lumens and make excellent use of battery life. Compact and powerful, these flashlights use standard AA alkaline batteries and fit easily in a pocket. A new lock-out tailcap switch on Alpha and Alpha Max features a high and low

setting with 20 hour run-time on low. Rugged aircraft aluminum construction protects the high-tech circuitry and the LEDs. The Deep Pocket™ carry clip holds the light securely in your pocket where it's easy to find and is removable if it is not needed. Check out the latest in innovative handheld lighting technology right here.

ALPHA, ALPHA MAX AND ZETA FLASHLIGHTS

• Alpha shines over 85 meters, and Alpha Max shines over 120 meters — both are no bigger than a shotgun shell • Digital circuitry delivers maximum power using only one battery • Rugged Tactical Hunter design with two-stage lock-out switch for long run time • Deep Pocket™ carry clip • Camo models feature Dura-Touch® Armor Coating **LENGTH** Alpha: 4.0" • Alpha Max: 3.9" • Zeta: 5.9" **BRIGHTNESS** Alpha: 100 Lumens, • Alpha Max: 140 Lumens • Zeta: 120 lumens **EFFECTIVE DISTANCE** Alpha: 85 meters • Alpha Max: 120 meters • Zeta: 120 meters



3711242

TACTICAL HUNTER

LONG RUN TIME
UP TO 20h

NEW L.E.D.
40% BRIGHTER



3711239



3711231

NEW L.E.D.
10% BRIGHTER



NEW L.E.D.
40% BRIGHTER

3711232

DESCRIPTION	LED	CODE #	BATTERIES	BATTERY LIFE	LUMENS	SUGG. RETAIL
Tactical Hunter Alpha, Black	Luxeon Rebel	3711231	(1) AA Alkaline	High: 1.5 hours; Low: 20 hours	100	\$44.99
Tactical Hunter Alpha Max, Black	Cree XP-G	3711239	(1) AA Alkaline	High: 1.5 hours; Low: 20 hours	140	49.99
Tactical Hunter Alpha Max, MONBU	Cree XP-G	3711232	(1) AA Alkaline	High: 1.5 hours; Low: 20 hours	140	54.99
Tactical Hunter Zeta, MONBU	Cree XR-E	3711242	(2) AA Alkaline	3.0 hours	120	64.99

CATALYST FLASHLIGHTS

- Our brightest two battery flashlights are 20% brighter this year
 - Rugged, tactical-style thumb switch with lock-out switch
 - Features the brightest available LEDs for maximum distance and lumens
 - Deep Pocket™ carry clip keeps the light secure in your pocket
 - Max View™ focused square beam for instant area illumination
 - Both models feature a high-low switch with a fast-strobe setting
 - Incredible 60 hour run time on low
 - All-aluminum construction with unbreakable lens
 - Camo model features Dura-Touch® Armor Coating
- LENGTH 5" BRIGHTNESS 210 lumens**
EFFECTIVE DISTANCE 190 meters



3711230



NEW L.E.D.
20% BRIGHTER



3711235

HUNT MASTER VXT

The Hunt Master VXT is 10% brighter than last year and features a powerful green LED for maximum stealth and enhanced night vision. The Cree® XP-C green LED is a bright 70 lumens, about 15 times more powerful than a standard 4-5 lumen green LED, sending the beam past 70 meters. Two Cree XP-E LEDs emit 250 lumens of clean white light. The VXT also features an adjustable spot-to-flood lens design and a memory feature that returns the light to the last setting you used.

- Powerful 70 lumen green LED
 - Focusable lens for flawless spot beam
 - Smaller than a 2D flashlight
 - CR123A batteries operate to -40° F
 - All-aluminum construction with unbreakable lens
 - High-power LEDs are rated for 100,000 hours use
- LENGTH 6.5" BRIGHTNESS 250 lumens**
EFFECTIVE DISTANCE 100 meters



3711211

NEW L.E.D.
10% BRIGHTER

HUNT MASTER

With three Luxeon® Rebel LEDs and an awesome 360 lumen output, the Hunt Master is the brightest flashlight in our line-up — 20% brighter than last year. It utilizes advanced circuitry to manage power from three CR123A batteries to leave larger, heavier flashlights in the dark. The Hunt Master also features an adjustable spot-to-flood lens design to focus light to your needs, and a fast strobe setting for signaling and personal safety. Now with high and low settings, and a 100 hour run time on low. Precision aluminum housing.

- Focusable lens for flawless spot beam
 - Smaller than a 2D flashlight
 - CR123A batteries operate to -40° F
 - All-aluminum construction with unbreakable lens
 - High-power LEDs are rated for 100,000 hours use
- LENGTH 6.5" BRIGHTNESS 360 lumens**
EFFECTIVE DISTANCE 150 meters



3711236

NEW L.E.D.
20% BRIGHTER



DESCRIPTION	LED	CODE #	BATTERIES	BATTERY LIFE	LUMENS	DISTANCE	SUGG. RETAIL
Catalyst, MONBU	Luxeon Rebel	3711230	(2) CR123A Lithium	High: 4.5 hours Low: 60 hours	210	190 meters	\$69.99
Catalyst, Black	Luxeon Rebel	3711235	(2) CR123A Lithium	High: 4.5 hours Low: 60 hours	210	190 meters	64.99
Hunt Master VXT, Black	(1) Cree XP-C Green (2) Cree XP-E White	3711211	(3) CR123A Lithium	High: 5 hours Low: 12 hours Green: 12 hours	High: 250 Low: 95 Green: 70	100 meters 60 meters 70 meters	99.99
Hunt Master, Black	(3) Luxeon Rebel	3711236	(3) CR123A Lithium	High: 3 hours Low: 100 hours	360	150 meters	99.99

PRO HUNTER FLASHLIGHTS

Pro Hunter flashlights feature long-running, powerful LEDs, rugged lightweight polymer bodies with rugged aluminum lens rings, and O-ring sealed for water resistance. The Classic Pro and Twin Beam+ are among the most powerful lights in their class. Both sport a screaming Cree® XP-C LED for maximum lumens and distance. The Twin-Beam+ includes a new "Mean Green" LED rated at 70 lumens, and a Soft-Sunshine LED for blood tracking. Affordable and easy to find AAA batteries are included with all models. A tactical-style lock-out end cap disables the switch to assure the light is not turned on accidentally. A carrying lanyard and ribbed body provide maximum grip in wet or cold weather. ANSI rated for water resistance. LEDs are rated for 50,000 to 100,000 hours and will not burn out under normal use.

RGB FLASHLIGHT

The Pro Hunter RGB features a pair of high-intensity LEDs for long distance, one wide view LED for maximum peripheral vision and one red-green-blue LED that enhances night vision and is stealthier around game animals. The RGB is a bright 40 lumens on the high setting. Black with matte aluminum lens ring. Three AAA alkaline batteries (included.) All this, and the RGB is easy on your wallet too.

PRO HUNTER LED

The original Pro Hunter flashlight features unbreakable, long-running LEDs. The center 0.5W LED pushes 25 lumens out to 50 meters and two green LEDs provide improved night vision and safety, and are stealthy around game animals. Dura-Touch® Armor Coating enhances your grip in all conditions.

CLASSIC PRO

Pure power is what these lights are all about. The Classic Pro is rated at 100 lumens, out to 100 meters and beyond. A tactical end-cap switch with high, low and flashing settings is simple to use and includes a lock-out that disables the switch to protect the batteries. The Classic Pro is certain to become a favorite for performance, good looks and cost-efficiency.

TWIN BEAM+

With 100 lumens in the main beam, the new Twin Beam+ is the ultimate hunting flashlight. The main beam uses a Cree® XP-C LED to throw 100 lumens of light out to 100 meters. A new green Cree XP-C LED emits 70 lumens — easily 15 times more powerful than other green LEDs that give off 4-5 lumens — for the maximum in stealthy brightness without disturbing the animals nearby. A Soft-Sunshine LED limits glare for better up-close map reading and tracking. The light flashes in any setting (including green) by holding down the switch for 2 seconds. Memory feature returns to the most recent setting when you turn the light back on. Three AAA batteries are included.



DESCRIPTION	LED	CODE #	BATTERIES	BATTERY LIFE	LUMENS	DISTANCE	SUGG. RETAIL
Pro Hunter RGB, Black	(2) Nichia 5mm Wide (1) Nichia 5mm Wide View (1) RGB LED	3713314	(3) AAA Alkaline	High+Wide: 25 hours High: 30 hours RGB: 40 hours	High+Wide: 40 High: 30 RGB: 3-4	High+Wide: 25 meters High: 25 meters RGB: 8-12 meters	\$19.99
Pro Hunter LED, MOBU	Nichia 0.5 Watt + (2) 5mm Green, (2) Red	3713312	(3) AAA Alkaline	0.5 watt: 6 hours Green/Red: 30 hours	0.5 watt: 25 Green/Red: 6-8	0.5 watt: 50 meters Green/Red: 15 meters	34.99
Pro Hunter Classic Pro, Mossy Oak Pink	Cree XP-C	3713323	(3) AAA Alkaline	High: 6 hours Low: 24 hours	High: 100 Low: 35	High: 100 meters Low: 50 meters	39.99
Pro Hunter Classic Pro, Mossy Oak Break-Up Infinity	Cree XP-C	3713322	(3) AAA Alkaline	High: 6 hours Low: 24 hours	High: 100 Low: 35	High: 100 meters Low: 50 meters	39.99
Pro Hunter Twin Beam+, Charcoal	(1) Cree XP-C White (1) Cree XP-C Green (1) Soft-Sunlight 5mm LED	3713324	(3) AAA Alkaline	White: 6 hours Green: 6 hours SS LED: 32 hours	High: 100 Low: 70 SS LED: 10	High: 100 meters Low: 70 meters SS LED: 15 meters	44.99

CROSSFIRE FLASHLIGHT

- The brightness and distance of a 2-CR123 lithium battery flashlight, but using two standard AA batteries
- Housed in a rugged, lightweight polymer body with unbreakable LED
- Pushes a bright white beam out to 135 meters
- High setting at 125 lumens
- Low setting at 10 lumens that will run for 24 hours
- Lock-out tail cap switch keeps light from turning on accidentally
- Small, tough, very powerful and economical to use
- O-ring sealed for water-resistance

LENGTH 5.9" BRIGHTNESS 125 lumens EFFECTIVE DISTANCE 135 meters



DESCRIPTION	LED	CODE #	BATTERIES	BATTERY LIFE	LUMENS	DISTANCE	SUGG. RETAIL
NEW Crossfire 2AA Flashlight	Cree XP-C	3713310	(2) AA Alkaline	High: 3 hours Low: 24 hours	High: 125 Low: 10	High: 135 meters Low: 40 meters	\$29.99

spitfire AND PEN LIGHTS

Now 20% brighter for 2012, the value-packed, super bright LED Spitfire flashlight operates on two AA batteries. This tough, reliable flashlight is water-resistant and easily passes demanding "drop-tests" onto concrete from a height of 1 meter and higher. The highly-focused LED beam is tuned for long distances and shines out to 135 meters. A tactical-style tailcap switch is easy to operate and features a momentary on/off or lock-on.

NEW L.E.D.
20% BRIGHTER



3714120

SPITFIRE FLASHLIGHT

- Powerful Cree® XP-C LED for bright, reliable illumination
- LEDs are rated for 50,000 hours and will never need to be replaced
- Ultralight, ultratough machined aluminum construction
- Textured non-slip body for secure grip in wet weather
- O-ring sealed for water resistance
- LENGTH 6"**
- BRIGHTNESS 110 lumens EFFECTIVE DISTANCE 135 meters**

DESCRIPTION	LED	CODE #	BATTERIES	BATTERY LIFE	LUMENS	SUGG. RETAIL
Spitfire	Cree XP-C	3714120	(2) AA Alkaline	2.5 hours	110	\$34.95

HI POWER™ PEN LIGHT

- Powerful Cree® XP-C LED • Hi Power Pen Light is 3-4 times brighter than any other pen light
- Incredible 85 lumen output in a light no bigger than a ballpoint pen
- Will run up to 20 hours on low setting
- Super-bright Rapid-Strobe setting for personal safety and signalling
- Rugged, all-aluminum construction
- Pocket clip designed to hold tightly to all fabric thicknesses
- Lock-out tail cap switch
- O-ring sealed for water resistance
- Includes bore light adapter
- LENGTH 5.9"**
- BRIGHTNESS 85 lumens EFFECTIVE DISTANCE 60 meters**



3712210

LONG RUN TIME
UP TO **20h**
ANSI FL 3

DESCRIPTION	LED	CODE #	BATTERIES	BATTERY LIFE	LUMENS	DISTANCE	SUGG. RETAIL
NEW Hi Power 2AAA Pen Light	(1) Cree XP-C White	3712210	(2) AAA Alkaline	High: 4 hours Low: 20 hours	High: 85 Low: 10	High: 60 meters Low: 25 meters	\$34.99

MICROBLAST™ PEN LIGHTS

- Superbright Nichia® 5mm LED shines 3X brighter than most other pen lights
- Two bore light adapters included with AAA MicroBlast: red for map reading and white for firearm inspection and cleaning
- Covert Cover™ (AAAA models) slides up for spot beam, making the light unseen from the side
- Rugged all-aluminum construction with heavy-duty pocket clip
- Unbreakable LED lasts for 100,000 hours
- Two sizes: Ultra-slim with three AAAA batteries; Standard with two AAA batteries
- BRIGHTNESS 15 lumens EFFECTIVE DISTANCE 20 meters**

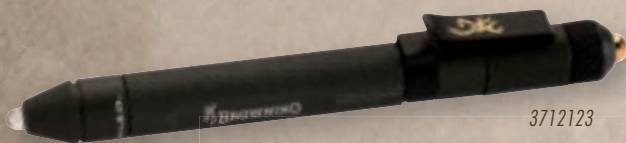

3712123

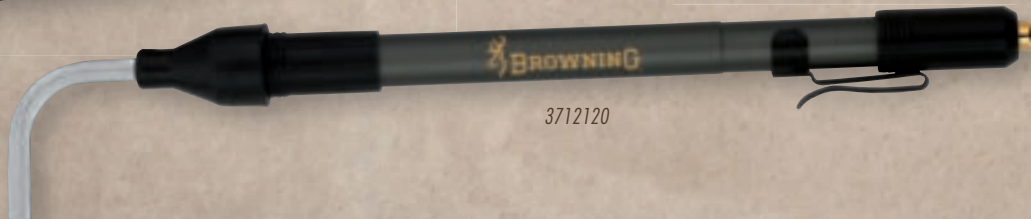

3712120

DESCRIPTION	LED	CODE #	BATTERIES	BATTERY LIFE	LUMENS	DISTANCE	SUGG. RETAIL
MicroBlast AAAA Pen Light w/ Bore Adapter	(1) 5mm Nichia White	3712120	(3) AAAA Alkaline	30 hours	15	20 meters	\$17.99
MicroBlast AAA Pen Light w/ 2 Bore Adapters	(1) 5mm Nichia White	3712123	(2) AAA Alkaline	10 hours	15	20 meters	17.99

PRO HUNTER HEADLAMPS

- All LED bulbs for reliability and maximum battery life
- 100,000 hour LEDs never need replacement
- Ultralight, ultratough polymer housing construction
- Comfortable elastic headband
- RGB includes a wide view LED for maximum peripheral vision and one red-green-blue LED that enhances night vision
- Escape features Soft-Sunlight LED that reduces glare to make reading and examining close objects easier on your eyes
- Maxus features Focus Control with adjustable spot-to-flood beam, three brightness levels and flashing

PRO HUNTER RGB HEADLAMP

Based on the best-selling Pro Hunter RGB flashlight, the RGB headlamp features the same extremely functional LED set with two high-intensity LEDs for long distance, a wide-view LED for maximum peripheral vision and one Red-Green-Blue LED. Colored LEDs enhance night vision and safety, and are more stealthy around game animals. Black front with charcoal accents.

PRO HUNTER ESCAPE HEADLAMPS

Escape headlamps feature three high-intensity LEDs for maximum brightness and long distances (up to 45 lumens and 40 meters) and one Soft-Sunlight LED for up-close lighting. The Soft-Sunlight LED is helpful when examining leaves, bark and grass at close distances for a blood trail, because it reduces glare and shadows. Also perfect for reading books and maps. Escape has three light settings, plus flashing. Maximum run time 32 hours. In Mossy Oak® camo patterns: Break-Up Infinity®, Duck Blind® and Blaze®.

PRO HUNTER MAXUS HEADLAMP WITH FOCUS-CONTROL

Maxus is a versatile, technically-advanced, powerful headlamp worthy of the name. Zoom lever on front adjusts the focus of the main LED from spot to flood. Powerful Cree® LED sends 85 lumens to 80 meters or more. Three light levels (High, Medium, Low) and Flashing setting extend the maximum run time on Low to 24 hours. Memory switch returns to the most recent setting when you turn the light on. Plus two green and two red LEDs offer maximum stealth, safety and protect night vision. Black front with charcoal accents.

Once you first use a Pro Hunter headlamp, you will reach for it time and time again. Not only do they free up both hands, but feature the latest in LED technology and circuit design to give the brightest output and longest run times. The three inexpensive AAA Alkaline batteries used to power Pro Hunter headlamps are interchangeable with many other devices such as GPS and walkie-talkies. Durable lightweight polymer housings feature easy-to-use switch buttons. All headlamps tilt up and down to direct the light where needed, and come with adjustable, snug-fitting elastic headstraps.



3713325



3713326



3713327



3713328



3713329

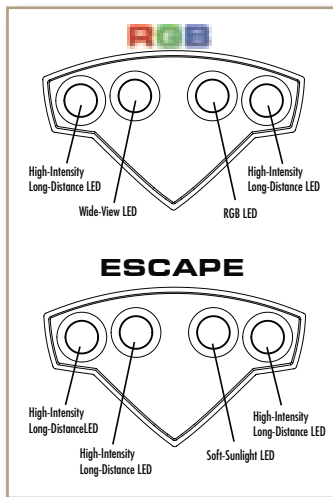

DESCRIPTION	LED	CODE #	BATTERIES	BATTERY LIFE	LUMENS	DISTANCE	SUGG. RETAIL
Pro Hunter RGB Headlamp, Black	(2) Nichia 5mm (1) Nichia 5mm Wide View (1) RGB LED	3713325	(3) AAA Alkaline	High+Wide: 25 hours High: 30 hours RGB: 40 hours	High+Wide: 40 High: 30 RGB: 3-4	High+Wide: 25 meters High: 25 meters RGB: 8-12 meters	\$24.99
Pro Hunter Escape Headlamp, MOINF	(3) Nichia 5mm (1) Soft-Sunlight 5mm LED	3713326	(3) AAA Alkaline	High: 10 hours Medium: 14 hours SS LED: 32 hours	High: 45 Medium: 40 SS LED: 10	High: 40 meters Medium: 40 meters SS LED: 10 meters	29.99
Pro Hunter Escape Headlamp, MO BLAZE	(3) Nichia 5mm (1) Soft-Sunlight 5mm LED	3713327	(3) AAA Alkaline	High: 10 hours Medium: 14 hours SS LED: 32 hours	High: 45 Medium: 40 SS LED: 10	High: 40 meters Medium: 40 meters SS LED: 10 meters	29.99
Pro Hunter Escape Headlamp, MODB	(3) Nichia 5mm (1) Soft-Sunlight 5mm LED	3713328	(3) AAA Alkaline	High: 10 hours Medium: 14 hours SS LED: 32 hours	High: 45 Medium: 40 SS LED: 10	High: 40 meters Medium: 40 meters SS LED: 10 meters	29.99
Pro Hunter Maxus Headlamp, Black	(1) Cree XP-C (2) Green 5mm (2) Red 5mm	3713329	(3) AAA Alkaline	High: 6 hours Medium: 10 hours Green, Red: 30-45 hours	High: 85 Medium: 50 Green, Red: 6-8	High: 80 meters Medium: 60 meters Green, Red: 15 meters	39.99

RENEGADE

RENEGADE HEADLAMPS

- Ultralight, ultrabright headlamps with powerful distance beams and colored LEDs for long battery life, stealth and improved night vision
- Nichia® white LEDs are twice as bright as the previous generation of LEDs
- White, red or green LEDs, plus flashing mode
- Wear as a headlamp or clip to your hat

BRIGHTNESS 50 lumens; WRG (white, red, green) LED: 25 lumens **EFFECTIVE DISTANCE** 40 meters; WRG (white, red, green) LED: 30 meters



3718171



3718141

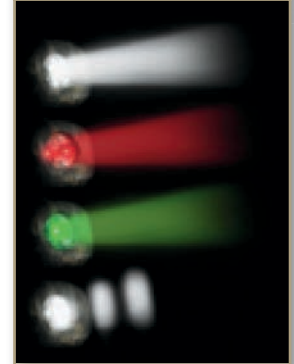

DESCRIPTION	LED	CODE #	BATTERIES	BATTERY LIFE	LUMENS	SUGG. RETAIL
Renegade 5 LED Headlamp, MONBU	5mm LEDs (2) White (2) Red, (1) Green	3718141	(3) AAA Alkaline	(2) Red, (2) White: 18 hours (1) Green: 50 hours	25	\$39.99
Renegade 5 LED Headlamp, MONBU	(5) 5mm White LEDs	3718171	(3) AAA Alkaline	(5) LEDs: 8h; (3) LEDs: 14 hours (1) LED: 32 hours	50	39.99

PHANTOM HEADLAMP

- Weighs only 2.4 oz. including single AA battery
- Choose between red, green or blue LEDs, plus a powerful Luxeon® white LED for distance
- Pivoting optical diffuser for flood lighting
- Clips to a cap or use with headstrap **BRIGHTNESS** 90 lumens **EFFECTIVE DISTANCE** 70 meters

The Phantom headlamp is 80% brighter in 2012. It's the smallest, most powerful AA headlamp in our line-up. It features a flip-down diffuser that softens light into a flood beam for up close tasks. A comfortable elastic headstrap and easy-to-use hat clip are included.

PHANTOM



3718343



Hat Clip

DESCRIPTION	LED	CODE #	BATTERIES	BATTERY LIFE	LUMENS	SUGG. RETAIL
Phantom, MOBU	Luxeon Rebel + (1) Red, (1) Green, (1) Blue 5mm	3718343	(1) AA Alkaline	Rebel LED: 1.5 hours 5mm LEDs: 25 hours	90	\$44.99



3712121

MICROBLAST™ HEADLAMP

- Ultralight headlamp is super bright and so small it goes unnoticed when worn
- Two Nichia® white LEDs for distance and general-purpose use, one green LED for stealth, safety and night vision
- Rugged polymer construction with Silent Hinge™
- Includes headstrap for use as a headlamp, or hat clip to attach to a cap **BRIGHTNESS** 10 lumens **EFFECTIVE DISTANCE** 15 meters



Hat Clip



Headband

MICROBLAST

DESCRIPTION	LED	CODE #	BATTERIES	BATTERY LIFE	LUMENS	SUGG. RETAIL
MicroBlast Headlamp	(2) 5mm Nichia White, (1) Green LED	3712121	(2) 2032 Lithium	White LEDs: 5 hours Green LED: 33 hours	10	\$14.99

NIGHT SEEKER™ RGB CAP LIGHT

- Adjustable tilt allows the light to pivot up and down to aim the light where it is needed
- Two white LEDs for all-purpose use
- One RGB LED offers night vision, safety and stealth
- Wear on the brim of a cap, as a pocket light or on a pack strap
- LEDs are rated for 100,000 hours use
- BRIGHTNESS** 15 lumens
- EFFECTIVE DISTANCE** 20 meters



3715100

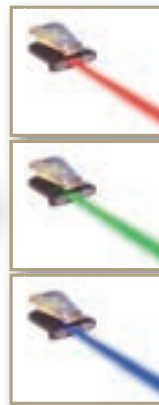

The Night Seeker™ RGB cap light features two white LEDs plus a cool RGB LED which shines first red, then green, then blue — all from a single LED — just by pushing the switch. Like other Night Seeker lights, the RGB is made from lightweight polymer with an integrated clip that swivels to allow the light to be easily directed.

NIGHT SEEKER™ PRO CAP LIGHT

- Adjustable tilt allows the light to pivot up and down to aim the light where it is needed
- One Nichia® 0.5 Watt LED for distance illumination
- Two green LEDs for night vision, safety and stealth
- Wear on the brim of a cap, as a pocket light or on a pack strap
- LEDs are rated for 100,000 hours use
- BRIGHTNESS** 20 lumens
- EFFECTIVE DISTANCE** 35 meters



3715099

Night Seeker™ PRO Cap Light



Free Standing

Cap Light

Pocket Light

NIGHT SEEKER™ CAP LIGHT

- Over 1.5 million sold
- Adjustable tilt allows the light to pivot up and down to aim the light where it is needed
- Two white LEDs are ideal for all-purpose use; one red LED for night vision and stealth
- Wear on the brim of a cap, as a pocket light or on a pack strap
- LEDs are rated for 100,000 hours use
- BRIGHTNESS** 15 lumens
- EFFECTIVE DISTANCE** 20 meters



3715081

Cap lights are one of the best ideas ever, and we have the best executed designs available. Night Seeker™ cap lights are durably constructed from a lightweight polymer to keep weight to a minimum. An integrated clip swivels to allow the light to be easily directed. The unique clip is also highly versatile. In addition to attaching to the brim of a cap, the clip can be attached to your shirt pocket, backpack strap or folded out to allow the light to stand on its own.

DESCRIPTION	LED	CODE #	BATTERIES	BATTERY LIFE / LUMENS	SUGG. RETAIL
Night Seeker RGB, MONBU	(2) Nichia 5mm + (1) 5mm RGB	3715100	(2) 2032 Lithium	White LEDs: 6.5 hours / 15	\$14.99
Night Seeker Pro, Black	Nichia 0.5 Watt + (2) 5mm Green	3715099	(1) AAA Alkaline	0.5W LED: 2 hours / 20	17.99
Night Seeker Cap Light, Black	(2) 5mm White, (1) Red	3715081	(2) 2032 Lithium	White LEDs: 6.5 hours / 15	9.99

combos AND NIGHT SEEKER



3712118



3712219

MICROBLAST™ LIGHT/KNIFE COMBO

MICROBLAST LIGHT Use as flashlight, cap light or keychain light • 5mm LED is brighter than many two AA flashlights • Digital circuitry delivers maximum power using only one battery • All aluminum construction with unbreakable lens • O-ring sealed for water resistance **LENGTH 2.9"**

BRIGHTNESS 15 lumens EFFECTIVE DISTANCE 20 meters

MICROBLAST KNIFE Folding knife with durable frame lock • 2" stainless steel blade holds a sharp edge

GETAWAY LIGHT/KNIFE COMBO

LED KEYCHAIN LIGHT Twist-switch for easy lock on and off • Nichia high-intensity white LED shines at 12 lumens • Rugged aircraft aluminum body with metal clip • O-ring sealed for water resistance • Includes four LR41 alkaline batteries (replaceable)

RUSS KOMMER DESIGNED KNIFE 2 3/4" stainless steel blade • Rugged aluminum handles • Ergonomic design contours to your hand • Thumbstud and pocket clip



3715039



3715038



NEW



NEW

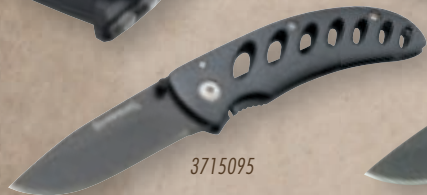

3715095



3715096

NIGHT SEEKER™ CAP LIGHT/KNIFE COMBO

CAP LIGHT Two white LEDs for long-distance and general use • One red LED for stealth and improved night vision • 2x2032 batteries included • Wear on cap brim, as a pocket light or on a pack strap • Dura-Touch® Armor Coating

RUSS KOMMER DESIGNED KNIFE Folding frame-lock knife with rugged aluminum handles • Razor-sharp 2 3/4" 440 stainless steel blade • Thumbstud and pocket clip

DESCRIPTION	LED	CODE #	BATTERIES	BATTERY LIFE	LUMENS	SUGG. RETAIL
MicroBlast Light/Knife Combo, Pink	(1) Nichia White LED	3712118	(1) AAA Alkaline	7 hours	15	\$24.99
MicroBlast Light/Knife Combo, Charcoal	(1) Nichia White LED	3712219	(1) AAA Alkaline	7 hours	15	24.99
NEW Getaway Light/Knife Combo, Black	(1) Nichia White LED	3715039	(1) LR-41 Alkaline	8 hours	12	19.99
NEW Getaway Light/Knife Combo, Pink	(1) Nichia White LED	3715038	(1) LR-41 Alkaline	8 hours	12	19.99
NEW Night Seeker Cap Light/Knife Combo, Black	(2) 5mm White, (1) Red	3715095	(2) 2032 Lithium	6.5 hours	15	19.99
NEW Night Seeker Cap Light/Knife Combo, MOBU	(2) 5mm White, (1) Red	3715096	(2) 2032 Lithium	6.5 hours	15	24.99



3715105

NIGHT SEEKER™ POCKET LIGHT

• Clips to a pocket or strap • Two Nichia® 5mm LEDs • Digital circuitry delivers maximum power • Push-button switch • Unbreakable LED and lens **BRIGHTNESS 15 lumens**

EFFECTIVE DISTANCE 20 meters

DESCRIPTION	LED	CODE #	BATTERIES	BATTERY LIFE	LUMENS	SUGG. RETAIL
Night Seeker Pocket Light	(2) Nichia 5mm White LEDs	3715105	(2) CR2032	High: 15 hours; Low: 6.5 hours	15	\$14.99





3712114

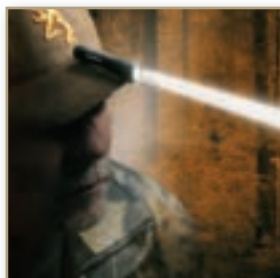

MICROBLAST FLASHLIGHT

- Use as flashlight or cap light • 0.5W LED is brighter than most AA flashlights
- Digital circuitry delivers maximum power using only one battery
- All aluminum construction with unbreakable lens • O-ring sealed for water resistance **LENGTH 2.9"**
- BRIGHTNESS 20 lumens**
- EFFECTIVE DISTANCE 35 meters**

DESCRIPTION	LED	CODE #	BATTERIES	BATTERY LIFE	LUMENS	SUGG. RETAIL
MicroBlast, Black	0.5 Watt White Luxeon	3712114	(1) AAA Alkaline	1.5 hours	20	\$19.99

Styled after our choke tubes, these handy keychain lights are small enough to go anywhere with you. A bright LED offers suitable light for small tasks with up to 8 hours of continuous run time.

CHOKE TUBE LED KEYCHAIN LIGHTS

- Nichia® high-intensity white LED • O-ring sealed for water resistance • Rugged aircraft-grade aluminum construction • Twist-switch for easy lock on and off
- LENGTH 1 3/8"** • Includes four LR41 batteries • Metal clip
- BRIGHTNESS 12 lumens** **EFFECTIVE DISTANCE 20 meters**

DESCRIPTION	LED	BATTERIES	BATTERY LIFE	LUMENS	SUGG. RETAIL
Midas	(1) Nichia White LED	(4) LR41	Up to 8 hours	12	\$9.99
Goose Band	(1) Nichia White LED	(4) LR41	Up to 8 hours	12	9.99
Full Strut	(1) Nichia White LED	(4) LR41	Up to 8 hours	12	9.99



Midas



Goose Band



Full Strut



The bright, easy to carry Echo keychain lights clip to a keychain and feature a long-lasting LED plus momentary and lock-on functions.

ECHO KEYCHAIN LIGHTS

- Nichia® 5mm white LED • Ultralight 1/2 oz. weight • Two replaceable 2016 lithium batteries included • Rugged polymer construction with rubber side grips and push-button
- BRIGHTNESS 12 lumens** **EFFECTIVE DISTANCE 18 meters**

DESCRIPTION	LED	CODE #	BATTERIES	BATTERY LIFE	LUMENS	SUGG. RETAIL
Black	(1) 5mm White	3713389	(2) 2016 Lithium	9 hours	12	\$9.99
MONBU	(1) 5mm White	3713390	(2) 2016 Lithium	9 hours	12	9.99



3713389



3713390

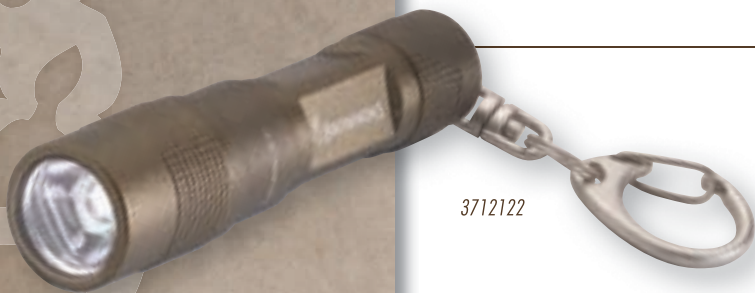

3712122

DUCK CALL LANYARD LIGHT

• Designed to clip to a call lanyard • Nichia® 0.5W LED is brighter than many larger flashlights • Digital circuitry delivers maximum power using a single AAA battery • Twist-switch prevents accidental activation • Rugged aircraft aluminum housing with unbreakable LED and lens • Extra-strong metal lanyard with spring clip **BRIGHTNESS** 20 lumens **LENGTH** 3" **EFFECTIVE DISTANCE** 35 meters

DESCRIPTION	LED	CODE #	BATTERIES	BATTERY LIFE	LUMENS	DISTANCE	SUGG. RETAIL
Duck Call Lanyard Light	Nichia 0.5W White LED	3712122	(1) AAA Alkaline	1.5 hours	20	35 meters	\$19.99

BUCKMARK® 6D LANTERN

- Bright fluorescent and LED lantern • Steady on and flashing modes
- Durable polymer and metal construction with rubber accents for durability

HEIGHT 9.25" **BRIGHTNESS** 350 lumens (Fluorescent)

There isn't a better camp lantern than the Buckmark 6D. The light source is a replaceable fluorescent bulb which puts out 350 lumens for 12 hours, perfect for use around camp and general purpose lighting, or turn it on to the economy setting (140 lumens / 20 hours). The second light source is a 0.5 watt white LED that will run for 168 hours (7 days) when long-term lighting, as in an emergency situation, is needed. The third light source is a pair of 5mm red LEDs that will run for 264 hours (11 days) for stealth lighting or reading a map and long-term use as a marker, a night light or hanging in the tent. The red LEDs can also be set to blinking mode in an emergency.



3717204

DESCRIPTION	LED	CODE #	BATTERIES	BATTERY LIFE	SUGG. RETAIL
Buckmark Lantern	Fluorescent; 0.5 Watt; (2) Red 5mm	3717204	(6) D Alkaline (not included)	High: 12 hours Low: 20 hours	\$79.99
7200 Replacement Bulb	13 Watt Fluorescent	3747200			22.49

FLASHLIGHT POUCHES

- Rugged Cordura® nylon (Lights not included)
- Full range of adjustments using hook and loop fasteners and a polymer snap buckle • Large pouch fits Hunt Master, Control Point and most Black Ice™ Flashlights • Small pouch fits Pro Hunter, Hi Power™, Spitfire and most Tactical Hunter flashlights



3749300

3749200

DESCRIPTION	CODE #	SUGG. RETAIL
Small Flashlight Pouch, Black	3749200	\$9.99
Large Flashlight Pouch, Black	3749300	11.99

FLASHLIGHT BATTERIES

- LR-41 batteries available in 4-packs • Used in Choke Tube Keychain lights and Browning Light pens • Difficult to find in stores • 2032 Lithium batteries fit Night Seeker™, Night Seeker RGB and Night Seeker Pocket Light • Delivers about twice the power per gram as alkaline batteries



3742200

3742100

DESCRIPTION	CODE #	SUGG. RETAIL
LR-41 Batteries (4-Pack)	3742200	\$3.50
2032 Batteries (4-Pack)	3742100	4.99

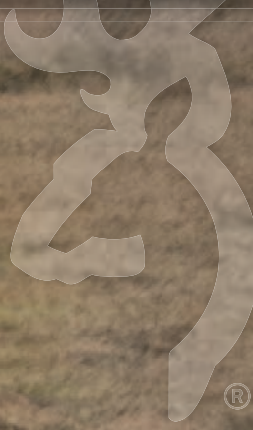

CLOTHING

NOW IN REALTREE CAMO.

WE ARE EXCITED TO ANNOUNCE THE ADDITION OF REALTREE® CAMO PATTERNS TO OUR LINE OF HUNTING CLOTHING.

We know that every hunter has their own sense of what works best when it comes to camouflage. We know that the background and vegetation for every hunt varies and that these conditions constantly change with the seasons. Selecting your camo to precisely match the conditions is the hallmark of the serious, successful hunter.

That's why we are pleased to now offer our most popular clothing items in your choice of Realtree or Mossy Oak camo patterns. These two great brands represent the backbone of the hunting camo industry. No matter when and where you hunt, Browning has the Realtree or Mossy Oak pattern that will let you fade into the background, never to be seen until it's time to smile for the camera with your once in a lifetime trophy animal.



REALTREE™



MOSSY OAK®
BRAND CAMO



HMX® BI-COMPONENT WATERPROOF BREATHABLE FABRIC TECHNOLOGY IS HERE.

Our clothing continues to lead the industry with high performance, Bi-Component HMX waterproof and breathable fabrics. HMX is different because it combines the advantages of the two most widely used technologies. Hydrophilic Monolithic systems do not transport perspiration vapor, but only the liquid perspiration formed when the vapor condenses. Hydrophobic Microporous systems transport vapor, but do not transport condensed perspiration. By using a Bi-Component system we utilize the advantages of both technologies to move both water vapor and condensed water to the outside of the garment keeping you protected from internal moisture. At the same time, HMX totally prevents water entry from the outside.

The revolutionary Bi-Component technology found in HMX fabrics provides the level of protection and comfort you have come to expect from Browning Technical Clothing, The Best There Is®.

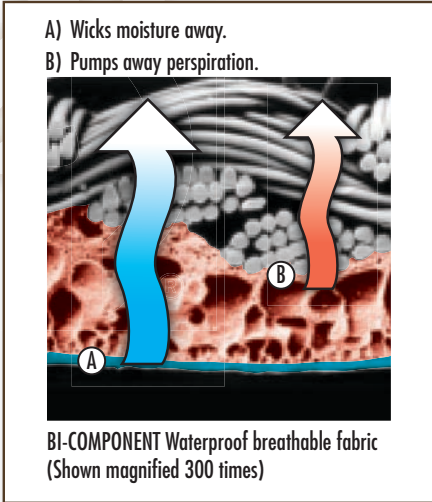

STAY WARMER WITH PRIMALOFT INSULATION

WHAT MAKES PRIMALOFT SO GOOD? IT KEEPS YOU WARM, IN ANY CONDITIONS, WET OR DRY.

PrimaLoft is a premium performance insulation engineered for superior warmth, water resistance, loft, softness and compressibility. These fibers are the finest in the industry and are densely packed to retain heat better for improved thermal efficiency. PrimaLoft fibers are specially treated to repel water molecules and absorb less water to make it more water-resistant and faster drying than other polyester insulations. Tightly-compressed fibers also make PrimaLoft highly wind-resistant as the smaller, finer fibers compress more and are lighter, less bulky, more breathable and extremely compressible. That's what makes our clothing with PrimaLoft insulation so good.

Being cold is a thing of the past with the addition of PrimaLoft insulation to the Browning Technical Clothing line-up. PrimaLoft is a premium performance, fine-fiber, high-loft insulation engineered to keep you warmer, drier and more comfortable in extreme conditions — even if it gets wet. PrimaLoft is so good, it was chosen by the US Military with over 1,000,000 PrimaLoft military garments deployed in active service around the world.

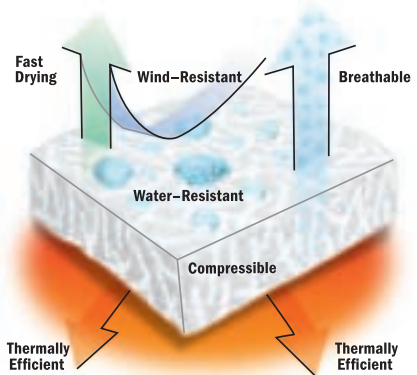

WHAT MAKES PRE-VENT SO GOOD? BEING WATERPROOF, WINDPROOF AND BREATHABLE.

Pre-Vent is our waterproof/breathable fabric that has stood the test of time. It was introduced in 2005 to meet the requests of demanding hunters who were tired of getting wet during difficult weather conditions. Since that time, thousands of satisfied hunters have come back time and again to Pre-Vent as the waterproof/breathable fabric of choice. It has been used in 2-Layer, 2.5-Layer and 3-Layer jackets, pants and gloves to meet different weather conditions and geographic differences.

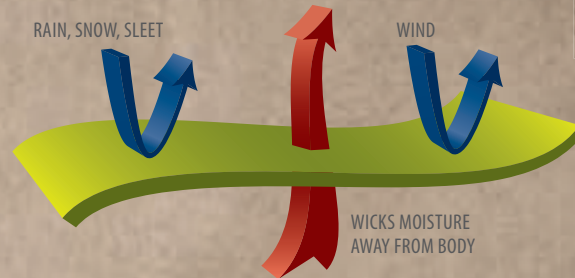

**WATER
NOT
INCLUDED™**

HOT NEWS — NO MORE COLD HANDS!

Cold hands are the bane of outdoorsmen, and the main cause is moisture collecting between the outer shell of the glove and the interior waterproof liner. It's just like inserting a small plastic bag inside a larger bag, then filling the space between the two bags with ice water. You can put your hand inside the inner bag and not actually be wet, but you'll still have cold, stiff fingers. We've adopted the new OutDry membrane lamination process that eliminates the space between the outer shell fabric and the inner waterproof liner so there's no place for chilling moisture to collect. We do this by inserting the waterproof liner into the outer glove shell, and then fusing the liner to the inside surface of the fabric shell. That means no more torn or loose fitting liners, no more soggy gloves and no more cold fingers. You also get a sleeker fit and improved finger dexterity so you'll be able to load and shoot with greater confidence. OutDry is everything a serious outdoor glove should be.

REVOLUTIONARY ODORSMART GIVES YOU AN ADVANTAGE IN THE GAME FIELD. IT CAN MAKE THE DIFFERENCE BETWEEN SUCCESS AND GOING HOME EMPTY HANDED. THE SECRET IS CONTROLLING ODORS BEFORE THEY BECOME A PROBLEM.

Odor is caused by specific bacteria that thrive on human skin. When bacteria metabolize, their waste produces odors that can be detected by deer and other big game animals. So how does OdorSmart work? Simply stated, OdorSmart attacks the bacteria on the skin and in the "microclimate" immediately around the skin, killing them BEFORE they have a chance to develop odors. With just normal use and care, OdorSmart will last for the life of the garment and does not require recharging or other special care. Just launder as instructed on the care label. OdorSmart technology is available in Browning base layers, in lining materials where it inhibits the growth of bacteria, and also in insulations where it attracts and neutralizes odor-causing bacteria in the structure of the insulation thus keeping it off the skin. The combination of OdorSmart in baselayer, linings and insulation provides you with multiple layers of defense against odor.



HYDRO-FLEECE — THE BEST IS BACK AND BETTER THAN EVER.

2-layer Hydro-Fleece with PrimaLoft® Sport insulation models are the warmest hunting parkas, jackets and pants we offer. The combination of the loftier soft shell fabric and thermally efficient PrimaLoft insulation provide a level of protection and comfort never before possible. Four pieces are available, including a parka and matching bib and a lighter weight jacket and pant. 3-layer Hydro-Fleece Soft Shell models add a new dimension with a form-fitting design to minimize weight and bulk. The 3-layer fabric features new Hydro-Fleece fabric on the outside with a smooth, fully-taped knit lining on the inside for ease of movement. Jacket and matching pant are available.



HYDRO-FLEECE PRIMALOFT® PARKA

- HMX® waterproof, breathable, bi-component 2-layer shell fabric
- Fully-taped seams
- OdorSmart™ anti-microbial lining helps control the bacteria that causes human odors
- PrimaLoft Sport insulation
- Two laser cut chest pockets with zippered closures
- Two oversized bellows pockets with magnetic flap closures
- Two handwarmer pockets behind bellows pockets
- Two inside pockets
- Waist drawcord
- Laminated watertight cuff closures with hook and loop adjustment
- Detachable hood with drawcord adjustment and molded brim
- Full-length front closure using 2-way Waterguard™ zipper
- Laminated internal zipper flap
- Stand-up, zip-through collar
- License tab **SIZES** S-3XL

CODE NUMBER	DESCRIPTION	SIZE	SUGG. RETAIL
30394220	Mossy Oak Break-Up Infinity	S-XL 2XL-3XL	\$327.25 348.50
30394221	NEW Realtree AP	S-XL 2XL-3XL	327.25 348.50



HYDRO-FLEECE PRIMALOFT® JACKET

- HMX® waterproof, breathable, bi-component 2-layer shell fabric
- Fully-taped seams
- OdorSmart™ anti-microbial lining helps control the bacteria that causes human odors
- PrimaLoft Sport insulation
- Chest pocket with zipper closure
- Two handwarmer pockets with zipper closures
- Internal security pocket with zipper closure
- Bottom drawcord adjusts from inside handwarmer pockets
- Internal sleeve cuffs
- Detachable hood with drawcord adjustment and molded brim
- Full-length front closure using two-way Waterguard™ zipper
- Laminated internal zipper flap
- Stand-up, zip-through collar
- License tab **SIZES** S-3XL

CODE NUMBER	DESCRIPTION	SIZE	SUGG. RETAIL
30494220	Mossy Oak Break-Up Infinity	S-XL 2XL-3XL	\$292.00 315.00
30494221	NEW Realtree AP	S-XL 2XL-3XL	292.00 315.00



WHAT DOES IT MEAN TO BE WATERPROOF?

Here's what makes Browning technical clothing different from many of our competitors. Waterproof fabrics like HMX® and Pre-Vent® have been specially created to meet our very high standards for waterproofness and breathability. Since shell fabrics are your first defense against the elements, we don't cut corners on quality. Taped Seams mean that every seam is fully-taped or we don't call it "waterproof." End of story. We are very involved in developing the correct tape and using only manufacturers who have years of experience seam-taping garments. Construction of Browning waterproof garments means they are designed and constructed to resist water entry at all closures including the cuffs, hoods, pockets and zippers. The Browning name is your assurance that corners are never cut for the sake of cost. When you see the HMX or Pre-Vent labels on our garments, you know you can rely on them to perform to the highest standards.

HYDRO-FLEECE PRIMALOFT® BIB

- HMX® waterproof, breathable, bi-component 2-layer shell fabric • Fully-taped seams • OdorSmart™ anti-microbial lining helps control the bacteria that causes human odors • Primaloft Sport insulation • Full-length, side seam two-way zippers with storm flaps • Rib knit side vent gussets • Elasticized suspenders with cam lock buckle • Rear zippered pocket • Zippered front opening with two-way zipper and storm flap **SIZES** S-3XL



CODE NUMBER	DESCRIPTION	SIZE	SUGG. RETAIL
30694220	Mossy Oak Break-Up Infinity	S-XL 2XL-3XL	\$233.50 257.00
30694221	NEW Realtree AP	S-XL 2XL-3XL	233.50 257.00



HYDRO-FLEECE PRIMALOFT® PANT

- HMX® waterproof, breathable, bi-component 2-layer shell fabric • Fully-taped seams • OdorSmart™ anti-microbial lining helps control the bacteria that causes human odors • Primaloft Sport insulation • Differential cut waistband is higher in the back to prevent drafts when sitting • Zippered fly • Two front pockets, two zippered cargo pockets and one rear pocket • Zip-to-knee cuff openings • Belt loops **SIZES** S-3XL

CODE NUMBER	DESCRIPTION	SIZE	SUGG. RETAIL
30294220	Mossy Oak Break-Up Infinity	S-XL 2XL-3XL	\$186.50 210.00
30294221	NEW Realtree AP	S-XL 2XL-3XL	186.50 210.00



HYDRO-FLEECE SOFT SHELL JACKET

- HMX® waterproof, breathable, bi-component 3-layer soft shell fabric
- OdorSmart™ anti-microbial lining helps control the bacteria that causes human odors
- Fully-taped seams using matching 3-layer tape
- Backpack friendly handwarmer pockets
- Zippered inside security pocket
- Bottom drawcord adjusts from inside handwarmer pockets
- Laminated watertight cuffs with hook and loop adjustment
- Attached hood rolls up and stores behind collar
- Full-length two-way front closure with Waterguard™ zipper
- Laminated internal zipper flap
- License tab **SIZES** S-3XL

CODE NUMBER	DESCRIPTION	SIZE	SUGG. RETAIL
30494420	Mossy Oak	S-XL	\$257.00
	Break-Up Infinity	2XL-3XL	280.00
30494421	NEW Realtree AP	S-XL	257.00
		2XL-3XL	280.00



HYDRO-FLEECE SOFT SHELL PANT

- HMX® waterproof, breathable, bi-component 3-layer soft shell fabric
- OdorSmart™ anti-microbial lining helps control the bacteria that causes human odors
- Fully-taped seams using matching 3-layer tape
- Differential cut waistband is higher in the back to prevent drafts when sitting
- Zippered fly
- Two front pockets, two zippered cargo pockets and one rear pocket
- Padded articulated knees
- Zip-to-knee cuff openings
- Belt loops **SIZES** S-3XL

CODE NUMBER	DESCRIPTION	SIZE	SUGG. RETAIL
30294420	Mossy Oak	S-XL	\$221.50
	Break-Up Infinity	2XL-3XL	245.00
30294421	NEW Realtree AP	S-XL	221.50
		2XL-3XL	245.00





TRANSITIONS
base · insulation · protection

**TRANSITIONS —
AWARD WINNING PROTECTION**

Browning Transitions has won prestigious awards for design excellence and performance in the field including "Best of the Best" from *Field and Stream* and the "Award of Excellence" from *Sporting Classics*. We are very proud of these accomplishments and we are constantly innovating to help you stay warm and dry in the worst weather the Great Outdoors can throw at you.

All waterproof, breathable models in the Protection Layer feature HMX® bi-component fabrics for extreme waterproofness and high breathability for maximum comfort. We have also added a new PrimaLoft® vest and pant for a new dimension of warmth in the Insulation layer. The great layering concept represented by Transitions continues to make it one of the most versatile apparel assortments available by combining Base, Insulation and Protection layers, all utilizing leading-edge technology.

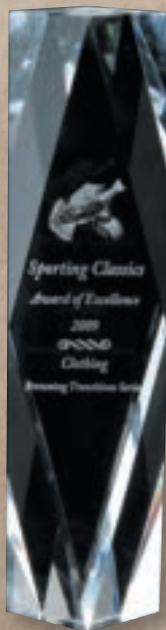
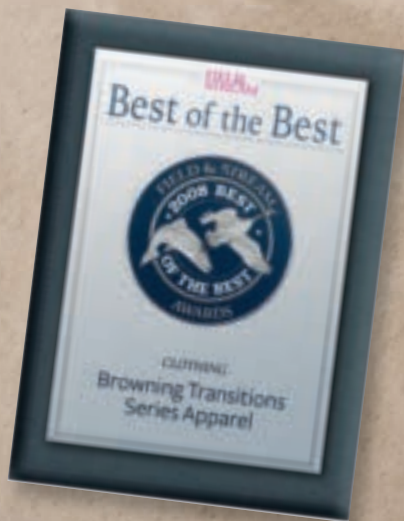

BASE layer

Base layer wicks perspiration away from the skin and keeps you warm and dry, not cold and clammy, even when moving. Anti-microbial technology is added to Big Game garments to control the growth of odor-causing bacteria to reduce human odor.



INSULATION layer

Insulation layer is available to meet specific needs based on weather conditions and activity level. In dry weather, layer 2 garments make excellent outer pieces. Choose from down or PrimaLoft® models.



PROTECTION layer

The Protection layer is the first line of defense against wind, rain and snow. Layer 3 garments are designed to maximize protection with minimal bulk. Choose one of several styles featuring HMX® or WindKill™.





TRANSITIONS®
base · insulation · protection



NTS VAPOR MAX TOP

- Nylon/Poly/Lycra® Vapor Max fabric • High insulation performance fabric • Insulates in cold temperatures • Wicks and transfers moisture away from your body during exertion • Quick drying and evaporating
- OdorSmart™ Technology featuring VisaEndurance® silver ion anti-microbial technology • Mock neck • Loose compression fit
- Browning corporate colors **SIZES** S-3XL

CODE NUMBER	DESCRIPTION	SIZE	SUGG. RETAIL
30118299	NEW Black	S-XL 2XL-3XL	\$42.50 47.50



NTS VAPOR MAX BOTTOM

- Nylon/Poly/Lycra Vapor Max fabric • High insulation performance fabric • Insulates in cold temperatures • Wicks and transfers moisture away from your body during exertion • Quick drying and evaporating
- OdorSmart™ Technology featuring VisaEndurance® silver ion anti-microbial technology • Loose compression fit • Elastic waist • Browning corporate colors
- SIZES** S-3XL

CODE NUMBER	DESCRIPTION	SIZE	SUGG. RETAIL
30218299	NEW Black	S-XL 2XL-3XL	\$42.50 47.50





TRANSITIONS
insulation - protection



NEW



Jacket shown stuffed into its own pocket

CODE NUMBER	DESCRIPTION	SIZE	SUGG. RETAIL
30489820	NEW Mossy Oak Break-Up Infinity	S-XL 2XL-3XL	\$140.00 151.50
30489821	NEW Realtree AP	S-XL 2XL-3XL	140.00 151.50
30489817	NEW Mossy Oak Duck Blind	S-XL 2XL-3XL	140.00 151.50
30489822	NEW Realtree Max-4	S-XL 2XL-3XL	140.00 151.50
30489848	NEW Salt Grass	S-XL 2XL-3XL	116.50 128.50

PRIMALOFT LINER JACKET

- PrimaLoft Sport Insulation provides warmth without bulk • Featherweight shell and lining fabrics for packability
 - Zippered chest pocket doubles as stuff bag • Two handwarmer pockets with zipper closures • Bottom drawcord adjusts from inside handwarmer pockets • Inside security pocket with zippered closure
- SIZES S-3XL**

PRIMALOFT — WARMER, DRIER, SOFTER.

Looks can be deceiving. At first glance our PrimaLoft clothing looks much like any other insulated clothing. In reality, it is much more. The combination of superfine PrimaLoft Sport insulation and highly-constructed shell and lining fabrics provide unbelievable warmth with minimal weight or bulk. Unlike down, PrimaLoft Sport continues to insulate even when wet, and dries incredibly fast. When you layer it under a waterproof shell, it offers outstanding protection from cold, wet weather. Because of its lightweight comfort and warmth, you may find yourself wearing it alone in less demanding weather.

The liner jacket and vest can stuff into the chest pocket for storage. The new pant has a stuff bag for storage.



NEW

PRIMALOFT LINER PANT

- PrimaLoft Sport Insulation provides warmth without bulk • Featherweight shell and lining fabrics for packability • Elasticized waist with drawcord adjustment for perfect fit • Zippered fly
 - Tailored cut to fit well under outer layer • Zippered cuff opening with stirrups to prevent them from riding up • Stuff bag included
- SIZES S-3XL**

CODE NUMBER	DESCRIPTION	SIZE	SUGG. RETAIL
30289848	NEW Salt Grass	S-XL 2XL-3XL	\$105.00 116.50



Pant shown stuffed into its own stuff bag

PRIMALOFT LINER VEST

- PrimaLoft Sport Insulation provides warmth without bulk
 - Featherweight shell and liner fabric • Zippered chest pocket doubles as a stuff bag • Two zippered handwarmer pockets
 - Drawcord bottom • Stand-up collar
- SIZES S-3XL**

CODE NUMBER	DESCRIPTION	SIZE	SUGG. RETAIL
30589848	NEW Salt Grass	S-XL 2XL-3XL	\$93.00 105.00





TRANSITIONS®
base • insulation • protection



700 FILL POWER DOWN JACKET

- 700 fill power goose down insulation provides maximum warmth with the least weight and bulk
- Backpack friendly design provides easy access to pockets
- Lycra® cuff and hem
- Contrasting side stripe
- Stuffs into internal pocket **SIZES S-3XL**



CODE NUMBER	DESCRIPTION	SIZE	SUGG. RETAIL
30476620	Mossy Oak	S-XL	\$163.50
	Break-Up Infinity	2XL-3XL	175.00
30476621	NEW Realtree AP	S-XL	163.50
		2XL-3XL	175.00
30476632	Tan	S-XL	151.50
		2XL-3XL	163.50
30476642	Olive	S-XL	151.50
		2XL-3XL	163.50

700 DOWN IS NATURE'S INSULATION.

Natural goose down has the highest warmth-to-weight ratio of any insulation making it the proven winner when it comes to warmth. That's why the Transitions Series uses the finest 700 fill power goose down. This specially selected down provides optimum loft and warmth with minimal weight. It is surrounded by high count, down-proof fabric to assure optimum loft and compactness. No coatings or laminations are added to maximize breathability. Although designed as insulation layer garments, they are great when used alone as outerwear in cold, windy, dry weather or layered under any Transition outer shell for maximum protection from the elements.



700 FILL POWER DOWN VEST

- 700 fill power goose down insulation provides maximum warmth with the least weight and bulk
- Backpack friendly design provides access to pockets
- Lycra® hem
- Contrasting side stripe
- Stuffs into internal pocket **SIZES S-3XL**

CODE NUMBER	DESCRIPTION	SIZE	SUGG. RETAIL
30576720	Mossy Oak	S-XL	\$128.50
	Break-Up Infinity	2XL-3XL	140.00
30576721	NEW Realtree AP	S-XL	128.50
		2XL-3XL	140.00
30576732	Tan	S-XL	116.50
		2XL-3XL	128.50
30576742	Olive	S-XL	116.50
		2XL-3XL	128.50





TRANSITIONS®
base • insulation • protection



ILLUSION SOFT SHELL JACKET

- HMX® waterproof, breathable, bi-component 3-layer soft shell fabric • OdorSmart™ anti-microbial lining helps control the bacteria that causes human odors • Fully-taped seams using matching 3-layer tape • Backpack friendly design provides easy access to handwarmer pockets • Inside security pocket • Bottom drawcord adjusts from inside handwarmer pockets • Laminated watertight cuffs with hook and loop adjustment • Hood rolls up and stores behind collar • Full-length front closure with Waterguard™ zipper • Laminated internal zipper flap • Stand-up, zip-through collar • License tab **SIZES** S-3XL

CODE NUMBER	DESCRIPTION	SIZE	SUGG. RETAIL
30487420	Mossy Oak Break-Up Infinity	S-XL 2XL-3XL	\$233.00 257.00
30487421	NEW Realtree AP	S-XL 2XL-3XL	233.00 257.00



ILLUSION — PURSUING PERFECTION.

Illusion combines the ruggedness, quietness and comfort of a soft shell with our HMX® bi-component waterproof, breathable fabric for the ultimate in hunting gear. Every seam has been sealed with matching 3-layer tape to make Illusion models truly waterproof for reliable protection in nasty conditions. OdorSmart™ anti-microbial treatment keeps human scent to a minimum. The form-fitting jacket minimizes bulk and weight and is backpack friendly, allowing you to access the pockets when wearing a pack. The pant moves easily with you, making it ideal for stalking game, and the new gloves offer the latest OutDry® protection against moisture and cold.



XTENDED PERFORMANCE OUTERWEAR



ILLUSION GLOVES

- Revolutionary OutDry® membrane lamination process for 100% waterproof protection • Elasticized wrist for snug fit • Overlays on palm, thumb and fingers • Articulated pre-curved fingers with Sensi-Flex trigger finger **SIZES** S-XL

CODE NUMBER	DESCRIPTION	SIZE	SUGG. RETAIL
30796420	Mossy Oak Break-Up Infinity	S-XL	\$93.00
30796421	NEW Realtree AP	S-XL	93.00



ILLUSION SOFT SHELL PANT

- HMX® waterproof, breathable, bi-component 3-layer soft shell fabric • OdorSmart™ anti-microbial lining helps control the bacteria that causes human odors • Fully-taped seams using matching 3-layer tape • Differential cut waistband is higher in the back to prevent drafts when sitting • Belt loops • Zippered fly • Two front pockets, two zippered cargo pockets and one rear pocket • Zip-to-knee cuff openings **SIZES** S-3XL

CODE NUMBER	DESCRIPTION	SIZE	SUGG. RETAIL
30287420	Mossy Oak Break-Up Infinity	S-XL 2XL-3XL	\$198.50 221.50
30287421	NEW Realtree AP	S-XL 2XL-3XL	198.50 221.50





TRANSITIONS®
base • insulation • protection

DILLON WINDKILL™ JACKET

- 100% windproof and highly breathable WindKill 3-layer fabric • OdorSmart™ anti-microbial lining helps control the bacteria that causes human odors
- Backpack friendly design provides easy access to handwarmer pockets
- Inside security pocket • Bottom drawcord adjusts from inside handwarmer pockets • Lycra® cuffs • Full-length front zipper closure internal zipper flap
- Fully-lined sleeves • Stand-up, zip-through collar • License tab **SIZES** S-3XL

CODE NUMBER	DESCRIPTION	SIZE	SUGG. RETAIL
30485920	Mossy Oak Break-Up Infinity	S-XL 2XL-3XL	\$163.50 175.00
30485921	NEW Realtree AP	S-XL 2XL-3XL	163.50 175.00



DILLON™

WHAT DOES IT MEAN TO BE WINDPROOF?

Our Dillon WindKill™ clothing is different because it's made from a laminated fabric that blocks the passage of wind through the fabric while breathing away perspiration. Our windproof clothing is designed and constructed to prevent wind from sneaking in through cuffs and zippers. This combination of laminated fabric and design features ensures that Dillon WindKill clothing is totally windproof, not just wind-resistant, and that's no empty, hot-air claim.

DILLON WINDKILL™ PANT

- 100% windproof and highly breathable WindKill 3-layer fabric • OdorSmart™ anti-microbial lining helps control the bacteria that causes human odors
- Elasticized waist with drawcord and belt loops • Zippered fly • Two front pockets and one rear pocket • Articulated knees • Zip-to-knee cuff openings **SIZES** S-3XL

CODE NUMBER	DESCRIPTION	SIZE	SUGG. RETAIL
30285920	Mossy Oak Break-Up Infinity	S-XL 2XL-3XL	\$116.50 128.50
30285921	NEW Realtree AP	S-XL 2XL-3XL	116.50 128.50



DILLON WINDKILL™ GLOVES

- Wind- and water-resistant fabric shell matches our Dillon clothing • Overlays on palm and thumb • Gripping surfaces on fingers • Open cuff **SIZES** S-XL

CODE NUMBER	DESCRIPTION	SIZE	SUGG. RETAIL
30785920	Mossy Oak Break-Up Infinity	S-XL	\$40.50
30785921	NEW Realtree AP	S-XL	40.50





TRANSITIONS®
base • insulation • protection



DELUGE JACKET

- Ultra-light HMX® 2.5-layer fabric • Seams are sealed with matching 2.5-layer tape • Zippered handwarmer pockets • Set-in sleeve construction • Attached hood with drawcord adjustment and molded brim
- Elasticized cuffs with hook and loop adjustment
- Full-front zipper closure with WaterGuard™ zipper and chin guard • Bottom drawcord adjusts from inside pockets • License tab • Stuff bag included **SIZES** S-3XL



Jacket shown stuffed into its own stuff bag



CODE NUMBER	DESCRIPTION	SIZE	SUGG. RETAIL
30486720	Mossy Oak Break-Up Infinity	S-XL 2XL-3XL	\$186.50 198.00
30486721	NEW Realtree AP	S-XL 2XL-3XL	186.50 198.00

DELUGE PANT

- Ultra-light HMX® 2.5-layer fabric • Seams are sealed with matching 2.5-layer tape • Elasticized waist with drawcord and belt loops • Two front pockets and one rear pocket • Elasticized cuffs • Zip-to-knee cuffs with WaterGuard™ zippers • Stuff bag included **SIZES** S-3XL



CODE NUMBER	DESCRIPTION	SIZE	SUGG. RETAIL
30286720	Mossy Oak Break-Up Infinity	S-XL 2XL-3XL	\$116.50 128.50
30286721	NEW Realtree AP	S-XL 2XL-3XL	116.50 128.50



Pant shown stuffed into its own stuff bag

DELUGE™

DELUGE — ULTRALIGHT WITH HEAVYWEIGHT PROTECTION.

Imagine carrying a full rain suit in your pack and forgetting it's there until the raindrops start falling. Then you'll experience the protection afforded by the lightweight HMX® 2.5-layer fabric in our Deluge rain gear. Deluge is so light and stuffs away into such a small package, it easily goes anywhere in a backpack. It can be worn alone in warmer weather, or layered over Base or Insulation layer garments when the rain or snow starts to fly.

XPO — EXCEPTIONAL COMFORT AND PERFORMANCE.

Our XPO (eXtended Performance Outerwear) is designed to be affordable, tough, comfortable and functional in all types of weather conditions. XPO features Pre-Vent®, a waterproof, windproof, breathable fabric that ensures protection from the most severe conditions you are likely to encounter in the field, yet remains breathable to let perspiration escape. Importantly, Pre-Vent does all this at a very competitive price, without skimping on other features that matter like abundant pockets, quality zippers and rugged construction.



XTENDED PERFORMANCE OUTERWEAR

XPO BIG GAME 4-IN-1 PARKA

SHELL Pre-Vent® waterproof, breathable shell fabric • Lining has mesh in upper body and nylon taffeta in lower body and arms • Set-in sleeves with one piece, no-seam construction • Articulated elbow for ease of movement • Watertight neoprene cuff with hook and loop tab • Two bellows pockets and handwarmer pockets • Pocket on left chest to accommodate our Gear 'Trierer® System • One inside security pocket with zipper closure • Internal waist drawcord • Detachable hood with molded visor, height adjustment drawcord and two button front closure • Two-way front closure with inner and outer storm flaps secured by five snaps • License tab in back • X-Change System compatible **LINER** Quiet camo shell fabric • Warm insulation • Solid color nylon taffeta lining • Reversible design • Set-in sleeves • Two pockets on each side • Elasticized waist • Rib knit cuffs • Fully-lined sleeves • Stand-up, zip-through collar • License tab **SIZES** S-3XL

XPO BIG GAME INSULATED PARKA

- Pre-Vent® waterproof, breathable shell fabric
- Warm insulation throughout • Brushed tricot lining
- Set-in sleeves with one piece, no-seam construction
- Articulated elbow for ease of movement • Watertight neoprene cuffs with hook and loop closure • Two bellows pockets and handwarmer pockets • Pocket on left chest to accommodate our Gear 'Trierer® System • One inside security pocket with zipper closure • Adjustable internal bottom drawcord • Detachable hood with molded visor, height adjustment drawcord and two button front closure • Two-way front zipper closure with inner and outer storm flaps secured by five snaps
- License tab in back **SIZES** S-3XL



CODE NUMBER	DESCRIPTION	SIZE	SUGG. RETAIL
30368820	Mossy Oak Break-Up Infinity	S-XL 2XL-3XL	\$210.00 233.50
30368821	NEW Realtree AP	S-XL 2XL-3XL	210.00 233.50



CODE NUMBER	DESCRIPTION	SIZE	SUGG. RETAIL
30369220	Mossy Oak Break-Up Infinity	S-XL 2XL-3XL	\$268.50 292.00
30369221	NEW Realtree AP	S-XL 2XL-3XL	268.50 292.00





CODE NUMBER	DESCRIPTION	SUGG. RETAIL
121011	Gear 'Trierer with Duck call Lanyard	\$38.00
121012	Gear 'Trierer with O-rings	27.00
121013	Lanyard only	15.00



CODE NUMBER	DESCRIPTION	SIZE	SUGG. RETAIL
30269620	Mossy Oak Break-Up Infinity	S-XL 2XL-3XL	\$140.00 151.50
30269621	NEW Realtree AP	S-XL 2XL-3XL	140.00 151.50



GEAR 'TRIEVER®

Our innovative Gear 'Trierer puts all your game calls, flashlights and other small accessories right at your fingertips. Just clip it into your pocket or to a gear strap. Give a quick pull and these items are instantly available. Let go and they instantly retract back into your pocket or pack. That means no more looking in the frozen mud for your favorite duck call or dropping your only flashlight out of the treestand in the early morning darkness.

XPO BIG GAME PANT

- Pre-Vent® waterproof, breathable shell fabric
- Brushed tricot lining
- Differential cut waistband is higher in the back to prevent drafts when sitting
- Grip strip waistband with suspender buttons
- Belt loops
- Zippered fly
- Two front pockets, two zippered cargo pockets and one rear pocket
- Zip-to-knee cuff openings with storm flaps

SIZES S-3XL



XPO BIG GAME INSULATED GLOVE

NEW

- Revolutionary OutDry® membrane lamination process for 100% waterproof protection
- PrimaLoft® insulation on palm and back for maximum warmth
- Elasticized wrist for snug fit
- Overlay on palm, thumb and fingers
- Articulated pre-curved fingers
- Hook and loop cuff closure

SIZES S-XL



CODE NUMBER	DESCRIPTION	SIZE	SUGG. RETAIL
30796320	NEW Mossy Oak Break-Up Infinity	S-XL	\$93.00
30796321	NEW Realtree AP	S-XL	93.00



XPO BIG GAME INSULATED BIB

- Pre-Vent® waterproof, breathable shell fabric
- Brushed tricot lining
- Full-length, side seam two-way zippers with storm flaps
- Rib knit side vent gussets
- Elasticized suspenders with cam lock buckle
- Rear zippered pocket
- Zippered front opening with two-way zipper and storm flap

SIZES S-3XL

CODE NUMBER	DESCRIPTION	SIZE	SUGG. RETAIL
30669420	Mossy Oak Break-Up Infinity	S-XL 2XL-3XL	\$175.00 186.50
30669421	NEW Realtree AP	S-XL 2XL-3XL	175.00 186.50



XPO FOR HER AND XPO JUNIOR – BIG GAME OUTDOOR WEAR FOR YOUR WHOLE FAMILY.

A cold and wet experience can make or break a day hunting, even for your hunting partners. Fortunately, every member of your family can enjoy the same protection with XPO For Her and XPO Junior outerwear. XPO For Her and XPO Junior maximize comfort, warmth and mobility without the performance downgrades common in the other makers' hunting clothes. Make the outdoors more comfortable and more fun for everyone with XPO For Her and XPO Junior.



XPO FOR HER BIG GAME JACKET

- Pre-Vent® waterproof, breathable shell fabric
- Specifically cut and designed for women
- Insulated for warmth without bulk
- Adjustable hood • Differential cut
- Front wind flap • Two zippered bellows pockets plus inside security pocket
- Adjustable Lycra® cuffs
- Quiet, direct-attach zipper pulls
- Drawcord waist **SIZES** S-XL



XPO FOR HER BIG GAME BIB

- Pre-Vent® waterproof, breathable shell fabric • Specifically cut and designed for women • Insulated for warmth without bulk
- Two handwarmer pockets • Knit side gussets • Full-length front zipper • Full-length leg zippers • Zippered rear pocket **SIZES** S-XL



CODE NUMBER	DESCRIPTION	SIZE	SUGG. RETAIL
XPO FOR HER BIG GAME JACKET			
30460720	Mossy Oak Break-Up Infinity	S-XL	\$175.00
30460721	NEW Realtree AP	S-XL	175.00
XPO FOR HER BIG GAME BIB			
30660820	Mossy Oak Break-Up Infinity	S-XL	140.00
30660821	NEW Realtree AP	S-XL	140.00

XPO JUNIOR BIG GAME PARKA

- Pre-Vent® waterproof, breathable shell fabric • Cut specifically for junior builds
- Insulated for superior warmth • Adjustable hood • Differential cut is longer in the back to prevent drafts when sitting • Front wind flap • Two zippered bellows pockets plus inside security pocket • Adjustable cuffs • Quiet, direct-attach zipper pulls **SIZES** S (6-8), M (10-12), L (14-16), XL (18-20)

CODE NUMBER	DESCRIPTION	SIZE	SUGG. RETAIL
30367320	Mossy Oak Break-Up Infinity	S-XL	\$140.00
30367321	NEW Realtree AP	S-XL	140.00



XPO JUNIOR BIG GAME BIB

- Pre-Vent® waterproof, breathable shell fabric
- Cut specifically for junior builds • Insulated for superior warmth • Two handwarmer pockets • Knit side gussets • Full-length front zipper • Knee-length leg zippers • Rear pocket **SIZES** S (6-8), M (10-12), L (14-16), XL (18-20)

CODE NUMBER	DESCRIPTION	SIZE	SUGG. RETAIL
30667420	Mossy Oak Break-Up Infinity	S-XL	\$116.50
30667421	NEW Realtree AP	S-XL	116.50





HELL'S CANYON JACKET

- Rugged 3-layer fabric is silent in brush, windproof, breathable and highly water-resistant
- OdorSmart™ anti-microbial, moisture wicking fleece lining • Full-length front zipper with internal storm flap • Zippered handwarmer pockets • Zippered ventilator chest pockets • Bottom drawcord • Adjustable neoprene cuffs **SIZES** S-3XL



CODE NUMBER	DESCRIPTION	SIZE	SUGG. RETAIL
30481420	Mossy Oak Break-Up Infinity	S-XL	\$140.00
		2XL-3XL	151.50
30481421	NEW Realtree AP	S-XL	140.00
		2XL-3XL	151.50



CODE NUMBER	DESCRIPTION	SIZE	SUGG. RETAIL
30796520	NEW Mossy Oak Break-Up Infinity	S-XL	\$35.00
30796521	NEW Realtree AP	S-XL	35.00

HELL'S CANYON BEANIE

- Four-way stretch fabric assures comfortable fit
- Warm, comfortable lining • Easily stuffs away into pocket or pack **SIZES** One size fits most

CODE NUMBER	DESCRIPTION	SIZE	SUGG. RETAIL
30894120	Mossy Oak Break-Up Infinity	one size	\$35.00
30894121	NEW Realtree AP	one size	35.00

HELL'S CANYON PANT

- Rugged 3-layer fabric is silent in brush, windproof, breathable and highly water-resistant • OdorSmart™ anti-microbial, moisture wicking fleece lining • Differential cut waistband is higher in the back to prevent drafts when sitting • Grip strip waistband with suspender buttons • Belt loops • Zippered fly • Two front pockets, two zippered cargo pockets and one rear pocket **SIZES** S-3XL

CODE NUMBER	DESCRIPTION	SIZE	SUGG. RETAIL
30281520	Mossy Oak Break-Up Infinity	S-XL	\$140.00
		2XL-3XL	151.50
30281521	NEW Realtree AP	S-XL	140.00
		2XL-3XL	151.50



HELL'S CANYON — AS TOUGH AS YOU ARE.

Tough as nails, our Hell's Canyon is a top-seller because it offers tremendous value and performance. The rugged 3-layer fabric is both water- and wind-resistant. The moisture-wicking OdorSmart™ fleece on the inside keeps you warm and helps control human odor. Go the distance in Hell's Canyon.



HELL'S CANYON GLOVES

- Wind- and water-resistant Hell's Canyon fabric throughout • Overlay on palm and thumb for firm grip • Contoured trigger finger • Comfortable fleece cuffs for snug fit **SIZES** S-XL



**HELL'S CANYON FULL THROTTLE
— GO TOP SPEED.**

Lighter weight Hell's Canyon Full Throttle gear brings a level of high performance to your hunt. The 2-layer fabric features a rugged water- and wind-resistant woven outer shell bonded to moisture-wicking OdorSmart™ featherweight fleece on the inside. Because there is no lamination layer, there is less resistance to airflow through the fabric for increased breathability. You will stay dry and comfortable in warmer weather and higher activity levels as perspiration is quickly moved away from your body. Crank up the intensity of your next hunt with Hell's Canyon Full Throttle.



HELL'S CANYON FULL THROTTLE JACKET

- Woven 2-layer bonded fabric is highly water- and wind-resistant and extremely breathable
- Lightweight moisture wicking fleece lining with OdorSmart™ anti-microbial technology
- Differential cut (longer in the back)
- Stand-up, zip-through collar with double-pull closure
- On-seam handwarmer pockets
- Extra large zippered chest pockets
- Bottom drawcord **SIZES** S-3XL

CODE NUMBER	DESCRIPTION	SIZE	SUGG. RETAIL
30497720	Mossy Oak Break-Up Infinity	S-XL	\$116.50
30497721	NEW Realtree AP	2XL-3XL	128.50
		S-XL	116.50
		2XL-3XL	128.50



HELL'S CANYON FULL THROTTLE PANT

- Woven 2-layer fabric is highly water- and wind-resistant and extremely breathable
- Lightweight moisture wicking fleece lining with OdorSmart™ anti-microbial technology
- Zip-to-knee cuff openings
- Elasticized waist with drawcord and belt loops
- Zippered fly
- Two front pockets, one zippered rear security pocket
- Articulated knee for extra mobility **SIZES** S-3XL

CODE NUMBER	DESCRIPTION	SIZE	SUGG. RETAIL
30297720	Mossy Oak Break-Up Infinity	S-XL	\$116.50
		2XL-3XL	128.50
30297721	NEW Realtree AP	S-XL	116.50
		2XL-3XL	128.50



4X MICROFLEECE JACKET

- Highly constructed microfiber fleece is wind-resistant and extremely quiet
- Backpack friendly design eliminates bulk and weight and provides easy access to pockets
- Duplex handwarmer pockets feature upper and lower section separated by internal zipper
- Set-in sleeves are fully lined for easy on/off and feature Lycra® cuff opening
- Two zippered handwarmer pockets and internal zippered security pocket
- Contrasting side stripe **SIZES S-3XL**

CODE NUMBER	DESCRIPTION	SIZE	SUGG. RETAIL
30479020	Mossy Oak Break-Up Infinity	S-XL	\$105.00
		2XL-3XL	116.50
30479021	NEW Realtree AP	S-XL	105.00
		2XL-3XL	116.50



4X MICROFLEECE GLOVES

- Soft, quiet 4X Microfleece is 4 times more windproof than regular fleece
- Overlays on palm and thumb
- Elasticized wrists **SIZES S-XL**

CODE NUMBER	DESCRIPTION	SIZE	SUGG. RETAIL
30785620	Mossy Oak Break-Up Infinity	S-XL	\$29.00
30785621	NEW Realtree AP	S-XL	29.00



4X MICROFLEECE PANT

- Highly constructed microfiber fleece is wind-resistant and extremely quiet
- Elasticized drawcord waist
- Belt loops
- Knee-length zippers
- One rear zippered pocket
- Zippered fly **SIZES S-3XL**

CODE NUMBER	DESCRIPTION	SIZE	SUGG. RETAIL
30279220	Mossy Oak Break-Up Infinity	S-XL	\$93.00
		2XL-3XL	103.50
30279221	NEW Realtree AP	S-XL	93.00
		2XL-3XL	103.50



4X MICROFLEECE — THE RIGHT FLEECE.

4X Microfleece has four times the wind resistance of regular fleece. It is ideal for nearly all hunting situations. Under fair skies, in warmer temperatures, 4X adds just the right amount of insulation and wind protection. When layered underneath a waterproof parka, it offers excellent insulating performance with little bulk.



THE STAPLE FOR EVERY HUNTER — 650 DOWN.

Down is the ultimate natural insulator. It is light, compact and extremely warm. For these reasons you should have down as a staple in your gear collection, and you need look no further than Browning. Our 650 Down Jackets and Vests make ideal layering garments in frigid conditions and are excellent as a stand alone piece. Their stylish look also makes them suitable to wear around the ranch or back in town when the temperatures drop.



650 DOWN JACKET

- Downproof microfiber shell • 650 fill power goose down insulation • Taffeta lining • Full-length front zipper closure
- Stand-up, zip-through collar • Drawcord adjustable bottom • Elasticized cuffs with hook and loop closure
- Two zippered lower slash pockets and single inside security pocket with zippered closure • Stuffs into included bag • X-Change System compatible **SIZES** S-3XL

CODE NUMBER	DESCRIPTION	SIZE	SUGG. RETAIL
30475320	Mossy Oak Break-Up Infinity	S-XL 2XL-3XL	\$151.50 163.50
30475321	NEW Realtree AP	S-XL 2XL-3XL	151.50 163.50
30475342	Olive	S-XL 2XL-3XL	140.00 151.50
30475332	Tan	S-XL 2XL-3XL	140.00 151.50
30475390	Black	S-XL 2XL-3XL	140.00 151.50



650 DOWN VEST

- Downproof microfiber shell • 650 fill power goose down insulation • Taffeta lining • Full-length front zipper closure • Stand-up, zip-through collar • Drawcord adjustable bottom • Two lower slash pockets and single inside pocket with zippered closure • Stuffs into included bag • X-Change System compatible **SIZES** S-3XL

CODE NUMBER	DESCRIPTION	SIZE	SUGG. RETAIL
30575420	Mossy Oak Break-Up Infinity	S-XL 2XL-3XL	\$116.50 128.50
30575421	NEW Realtree AP	S-XL 2XL-3XL	116.50 128.50
30575442	Olive	S-XL 2XL-3XL	105.00 116.50
30575432	Tan	S-XL 2XL-3XL	105.00 116.50
30575490	Black	S-XL 2XL-3XL	105.00 116.50

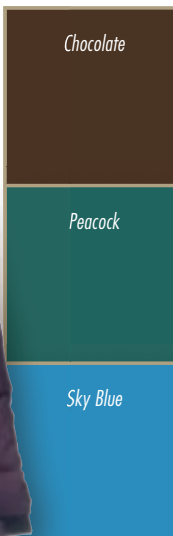

650 DOWN JACKET FOR HER

- Downproof microfiber shell • High-loft 650 fill power down insulation provides warmth without bulk
- Luxurious high thread count shell and lining fabrics
- Women's cut for comfortable fit • Bottom drawcord to lock in warmth • Hook and loop adjustable cuff closures
- Two zippered handwarmer pockets • Full-length front zipper closure with snap secured storm flap • Inside security pocket with zipper closure • Buckmark embroidery on left chest and right rear shoulder **SIZES** S-XL

CODE NUMBER	DESCRIPTION	SIZE	SUGG. RETAIL
30496148	NEW Plum	S-XL	\$151.50
30496131	NEW Chocolate	S-XL	151.50
30496143	NEW Peacock	S-XL	151.50
30496175	NEW Sky Blue	S-XL	151.50





HIGH COUNTRY JACKET

- Lofty down insulation • Rugged 100% polyester shell fabric to resist tears • Soft downproof lining fabric
- Adjustable cuff • Inside security pocket • Two handwarmer pockets with snap secured flap closures • Buckmark embroidery on left chest and center back collar **SIZES** S-3XL

NEW



CODE NUMBER	DESCRIPTION	SIZE	SUGG. RETAIL
30484420	NEW Mossy Oak Break-Up Infinity	S-XL 2XL-3XL	\$128.50 140.50
30484421	NEW Realtree AP	S-XL 2XL-3XL	128.50 140.00
30484434	NEW Gold	S-XL 2XL-3XL	116.50 128.50
30484441	NEW Forest Green	S-XL 2XL-3XL	116.50 128.50

HIGH COUNTRY JACKET FOR HER

- Lofty down insulation • Rugged 100% polyester shell fabric to resist tears • Soft downproof lining fabric • Women's cut for comfortable fit • Bottom drawcord to lock in warmth
- Elasticized cuffs • Two handwarmer pockets with snap secured flap closures • Buckmark embroidery on left chest and center back collar • Inside security pocket with zipper closure **SIZES** S-XL

NEW



CODE NUMBER	DESCRIPTION	SIZE	SUGG. RETAIL
30484320P	NEW Mossy Oak Infinity	S-XL	\$128.50
30484321P	NEW Realtree AP	S-XL	128.50
30484334	NEW Gold	S-XL	116.50
30484341	NEW Forest Green	S-XL	116.50

MOSSY OAK BREAK-UP INFINITY

BROWNING For Her



NEW

JUNIOR HIGH COUNTRY JACKET

- Lofty down insulation • Rugged 100% polyester shell fabric to resist tears • Soft downproof lining fabric
- Elasticized cuffs and bottom hem • Two handwarmer pockets with snap secured flap closures • Buckmark embroidery on left chest and center back collar

SIZES S (6-8), M (10-12), L (14-16), XL (18-20)

CODE NUMBER	DESCRIPTION	SIZE	SUGG. RETAIL
30460920	NEW Mossy Oak Infinity	S-XL	\$116.50
30460921	NEW Realtree AP	S-XL	116.50
30460934	NEW Gold	S-XL	105.00
30460941	NEW Forest Green	S-XL	105.00

BROWNING

THE HIGH COUNTRY JACKET IS THE CLASSIC COMBINATION OF STYLE, GOOD TASTE AND COMFORT.

Our new High Country Jackets are constructed to take you into the wilderness in comfort. The heavier outer shell fabric with a high tear strength takes the abuse from brush, trees, rocks, mud and machinery. The outer shell shields you from light rain and heavy winds, while warm down insulation protects you in freezing weather.

THE BIGGEST THING TO HIT THE MARSH SINCE THE INVENTION OF MUD.

If you thought everything that might improve waterfowl clothing had already been done, you need to listen to what a little dirty bird is telling you — it's our secret about the all-new Dirty Bird waterfowl line. In short, it's the most effective, ergonomic and comfortable clothing that has ever taken its place in a frozen pit blind or poled a jon boat through dark, flooded timber. We've taken our classic Pre-Vent® fabric, PrimaLoft® Synergy insulation and combined it with highly functional tailoring to produce a feature-rich selection of parkas, jackets, bibs and pants, along with base and insulation layers. They will keep you warmer, drier and more comfortable than anyone else in the marsh, including those dirty birds. Dirty Bird waterfowl. It's what you always wanted your waterfowling gear to grow up to be.

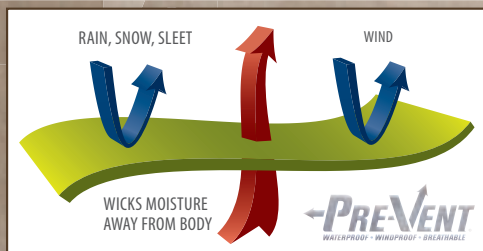

WATERPROOF, BREATHABLE PRE-VENT® FABRIC

On outerwear pieces, we use Pre-Vent, an exceptional 100% waterproof yet breathable fabric in the Dirty Bird shell. Pre-Vent easily shrugs off snow, sleet, rain, water, wind, mud and anything else that Mother Nature and your favorite marsh want to throw at you.

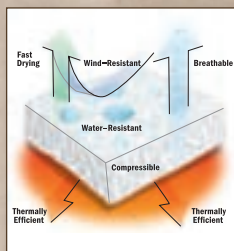

PRIMALOFT® SYNERGY INSULATION

Browning's PrimaLoft Synergy insulation is a combination of both fine and ultra fine fibers that raises the bar for continuous filament insulation. It's soft, lightweight, quick-drying and provides excellent insulating properties, even when wet. Because it doesn't require quilting to stay in place it won't restrict your freedom of movement. You'll find that hitting fast-flying crossing birds was never easier than when you're wearing a Dirty Bird jacket.

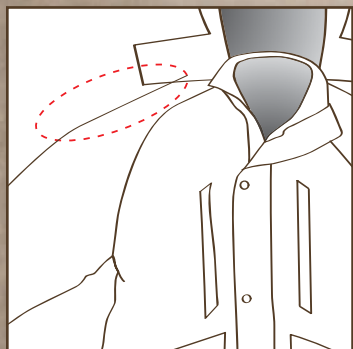

RAGLAN SLEEVE CONSTRUCTION

On outerwear the raglan sleeves are cut at a long tapering angle right up to the collar line. This means that the top of the sleeve is one seamless piece of fabric all along the shoulder with no exposed seams to leak, even in the worst downpours.

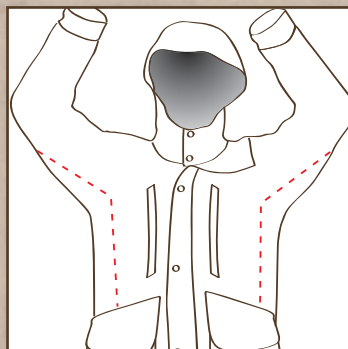

ARROW GUSSETS

The Arrow Gusset armpit design has a smooth, tapering shape as it rises along the side to under the sleeve. It makes the garment fit better and gives you a much greater range of movement. That's an important advantage when you're facing a big flock of dirty birds crossing both ways in front of your decoy spread.

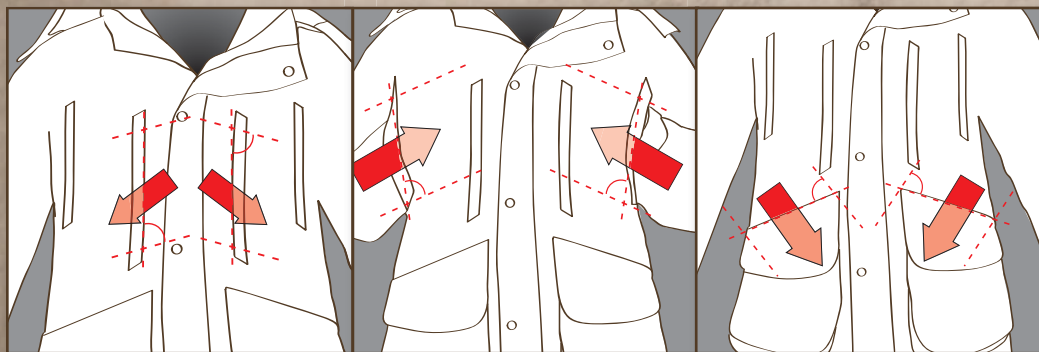

ANGLE-ENTRY POCKETS

Angle-Entry pockets are designed around the human arm and hand. When your hands are above your elbows they naturally point up, and when they are below your elbows they point down. The interiors of the two zippered chest accessory Angle-Entry pockets and the shell pockets are slanted down to more naturally fit your hands, while the two handwarmer Angle-Entry pockets slant up. No more breaking your wrists to fish another shell or a call out of your parka pockets.





JUST LOOK AT THAT DIRTY BIRD!

We start off with a durable, waterproof and breathable Pre-Vent® fabric shell that's tailored with a full raglan sleeve to eliminate sewn seams along the top of the shoulder. PrimaLoft® Synergy insulation is a mix of fine and ultrafine synthetic fibers that keep you warm and dry in any weather. The Arrow Gusset rises along the side and smoothly tapers under the arm pit to a sharp point to improve mobility and increase your range of motion. The Angle-Entry pockets are all designed around how the human hand and arm work, not the other way around. The opening and interior on each pocket easily accepts your hand, even when wearing gloves. You'll never have to tie yourself in knots just getting into your pockets again.



DIRTY BIRD 4-IN-1 PARKA

SHELL Pre-Vent® waterproof, breathable fabric shell • Angle-Entry pocket design • Two upper Angle-Entry handwarmer pockets • Two zippered chest Angle-Entry accessory pockets • Two lower bellows shell Angle-Entry pockets with magnetic closure and internal pleat • Raglan sleeve design eliminates top shoulder seam for a more waterproof design • Arrow Gusset arm pit design and articulated elbow for greater range of motion • Overlay forearm patches to prevent wear • Detachable, adjustable hood • Inside security pocket • External and internal storm flap • Adjustable, watertight laminated cuffs • Molded shoulder strips prevent wear on shoulder areas • Internal waist drawcord • Mesh moisture barrier strip between shell and lining • X-Change System compatible • License tab **LINER** Camo fleece reverses to solid-color woven fabric • PrimaLoft® Synergy insulation • Set-in sleeves • Elasticized bottom and cuffs • Two slash pockets on each side • X-Change System compatible **SIZES** S-3XL

CODE NUMBER	DESCRIPTION	SIZE	SUGG. RETAIL
30330017	NEW Mossy Oak Duck Blind	S-XL 2XL-3XL	\$350.50 362.00
30330022	NEW Realtree Max-4	S-XL 2XL-3XL	350.50 362.00

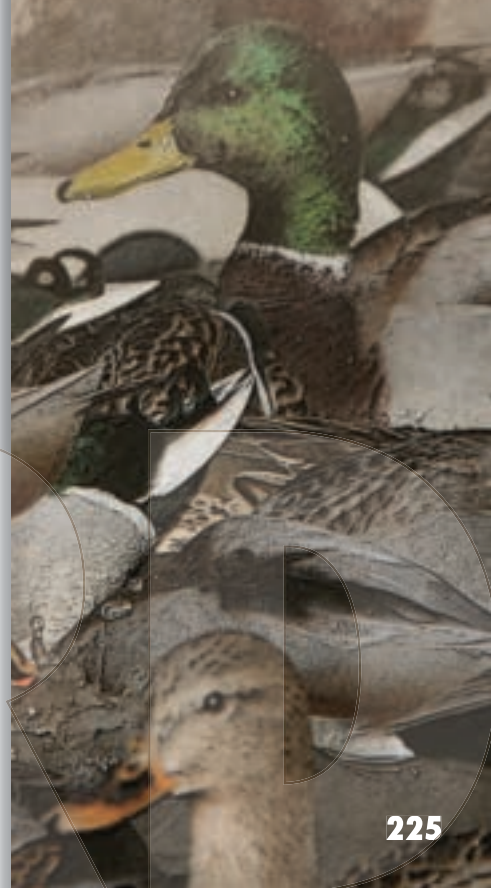

THESE DIRTY BIRDS LOVE COLD, NASTY WEATHER.

When the clouds settle low on the marsh, the wind is spitting industrial-grade sleet and your dog wants to share your hot coffee, you want to be wrapped in a Dirty Bird Insulated Parka or Wader Jacket. The waterproof, breathable Pre-Vent® fabric shell keeps water out and allows perspiration to escape. PrimaLoft® Synergy insulation keeps you warm, and the SelectWeight™ design puts more insulation around the torso to keep your body core warm, while lighter insulation is used in the sleeves to help you swing smoothly on those dirty birds when they finally decide to come calling on your decoys.

PS: Tell your dog that next time it's his turn to make the coffee.



DIRTY BIRD INSULATED PARKA

NEW

- Pre-Vent® waterproof, breathable fabric shell • PrimaLoft® Synergy insulation system maximizes warmth and freedom of movement
- Angle-Entry pocket design • Two upper Angle-Entry handwarmer pockets • Two zippered chest Angle-Entry accessory pockets • Two lower bellows Angle-Entry shell pockets with magnetic closure and internal pleat • Raglan sleeve eliminates top shoulder seam for a more waterproof design • Arrow Gusset armpit design and articulated elbow for greater range of motion • Overlay forearm patches to prevent wear • Detachable, adjustable hood • Inside security pocket • External and internal storm flap • Adjustable, watertight laminated cuffs • Molded shoulder strips prevent wear on shoulder areas • Internal waist drawcord • Mesh moisture barrier strip between shell and lining
- License tab **SIZES** S-3XL



CODE NUMBER	DESCRIPTION	SIZE	SUGG. RETAIL
30330117	NEW Mossy Oak Duck Blind	S-XL 2XL-3XL	\$280.00 303.50
30330122	NEW Realtree Max-4	S-XL 2XL-3XL	280.00 303.50

DIRTY BIRD INSULATED WADER JACKET

NEW

- Pre-Vent® waterproof, breathable fabric shell • PrimaLoft® Synergy insulation maximizes warmth and freedom of movement • Angle-Entry pocket design
- Two upper Angle-Entry handwarmer pockets • Two lower bellows Angle-Entry shell pockets with magnetic closure and internal pleat
- Raglan sleeve eliminates top shoulder seam for a more waterproof design • Arrow Gusset armpit design and articulated elbow for greater range of motion • Overlay forearm patches to prevent wear
- Detachable, adjustable hood • Inside security pocket • Watertight zipper guard • Adjustable, watertight laminated cuffs • Molded shoulder strips prevent wear on shoulder areas • Mesh moisture barrier strip between shell and lining • Shorter wader design with elasticized waist • License tab **SIZES** S-3XL



CODE NUMBER	DESCRIPTION	SIZE	SUGG. RETAIL
30430117	NEW Mossy Oak Duck Blind	S-XL 2XL-3XL	\$268.50 280.00
30430122	NEW Realtree Max-4	S-XL 2XL-3XL	268.50 280.00



DIRTY BIRD INSULATED BIBS

- Pre-Vent® waterproof, breathable fabric shell • Primaloft® Synergy insulation • Overlay protection on seat, knees and inner cuff • Articulated knees for greater range of motion • Full-length, two-way side and front zippers with storm flaps • Rib knit side gussets • Elasticized shoulder straps with cam lock buckles
- One zippered rear pocket and one zippered chest pocket
- Mesh moisture barrier strip between shell and lining

SIZES S-3XL

CODE NUMBER	DESCRIPTION	SIZE	SUGG. RETAIL
30630117	NEW Mossy Oak Duck Blind	S-XL 2XL-3XL	\$221.50 245.00
30630122	NEW Realtree Max-4	S-XL 2XL-3XL	221.50 245.00



NEW



NEW

DIRTY BIRD BIBS

- Pre-Vent® waterproof, breathable fabric shell
- Overlay protection on seat, knees and inner cuff
- Articulated knees for greater range of motion
- Full-length, two-way side and front zippers with storm flaps • Rib knit side gussets • Elasticized shoulder straps with cam lock buckles
- One zippered rear pocket • One zippered chest pocket

CODE NUMBER	DESCRIPTION	SIZE	SUGG. RETAIL
30630217	NEW Mossy Oak Duck Blind	S-XL 2XL-3XL	\$186.50 198.50
30630222	NEW Realtree Max-4	S-XL 2XL-3XL	186.50 198.50



DIRTY BIRD FIELD PANTS

- Pre-Vent® waterproof, breathable fabric shell • Articulated knees for greater range of motion • Full-length, two-way side zippers with storm flaps • Rear security pocket • Two front handwarmer pockets • Nylon taffeta liner for easy on/off • Partial elasticized waistband • Belt loops and zippered fly

NEW

CODE NUMBER	DESCRIPTION	SIZE	SUGG. RETAIL
30230417	NEW Mossy Oak Duck Blind	S-XL 2XL-3XL	\$140.00 151.50
30230422	NEW Realtree Max-4	S-XL 2XL-3XL	140.00 151.50





MEANWHILE, BACK AT THE MARSH...

The weather looks better today. The wind has tapered off and your dog has finally stopped begging for more hot coffee. Today is perfect for trying out the new Dirty Bird Vari-Tech™ System. Start off with our base layer garment having a mid-layer fleece wrapped around your upper body and a stretchable lightweight poly-jersey fabric on the arms. Now add a waterproof, breathable top layer like the Dirty Bird Vari-Tech Jacket and Half Bib. The jacket has a high-performance Pre-Vent® waterproof, breathable outer shell and PrimaLoft® Synergy insulation. Like the base layer, the Vari-Tech design puts the high-loft insulation around your torso, while a lighter 3-layer bonded fabric is used in the jacket sleeves and bib legs for ease of movement. Any weather is great weather for ducks and the new Dirty Bird Vari-Tech waterfowl clothing.



VARI-TECH™ DESIGN

Our new Vari-Tech Temperature and Motion Design combines heavier insulation in the body where you need it to stay warm and lighter insulation in the sleeves where you want a full range of motion. PrimaLoft® Synergy insulation is used in the body of the jacket and a bonded 3-layer fabric in the sleeves so you get warmth where you want it and ease of movement where you need it. You get the best of both worlds with Vari-Tech.

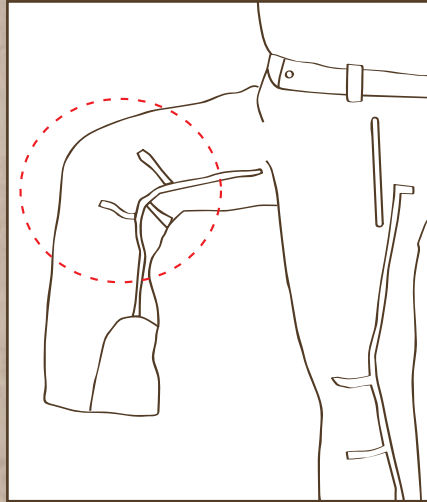

ARTICULATED KNEE CONSTRUCTION

Our new Vari-Tech Temperature and Motion Design adds highly-tailored pleated leg construction that is pre-curved to follow the natural bend of your knee. This means less bunching of material behind your knee when sitting in your blind or boat, and greater ease of motion when your hunt requires active movement through brush, mud and other obstacles, or when climbing in and out of boats and blinds.

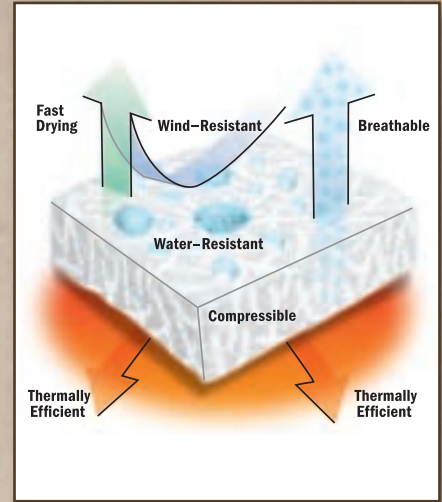

PRIMALOFT® SYNERGY INSULATION

PrimaLoft Synergy insulation is a combination of both fine and ultra fine fibers that raises the bar for continuous filament insulation. It's soft, lightweight, quick-drying and provides excellent insulating properties, even when wet. Because it doesn't require quilting to stay in place, it won't restrict your freedom of movement. You'll find that hitting fast-flying crossing birds was never easier than when you're wearing a Dirty Bird Jacket.



DIRTY BIRD VARI-TECH™ BASE LAYER

- Vari-Tech Temperature and Motion Design • Midweight 200-gram fleece body • Lightweight stretchable poly jersey in the sleeves • Mock neck design
- Keeps core warm • Allows for freedom of movement in arms **SIZES** S-3XL

CODE NUMBER	DESCRIPTION	SIZE	SUGG. RETAIL
30160017	NEW Mossy Oak Duck Blind	S-XL 2XL-3XL	\$46.50 52.50
30160022	NEW Realtree Max-4	S-XL 2XL-3XL	46.50 52.50



NEW



NEW

DIRTY BIRD VARI-TECH™ JACKET

- Pre-Vent® waterproof, breathable fabric • Fully-taped external seams
- Vari-Tech Temperature and Motion Design • PrimaLoft® Synergy insulation in the body • 3-layer laminate fabric in sleeves • Adjustable, watertight laminated cuffs • Articulated elbows • Two upper and two lower zippered pockets • Detachable hood with drawcord • Full-length water-resistant zipper with inner and outer storm flaps • Drawcord bottom • License tab **SIZES** S-3XL

CODE NUMBER	DESCRIPTION	SIZE	SUGG. RETAIL
30330217	NEW Mossy Oak Duck Blind	S-XL 2XL-3XL	\$268.50 280.00
30330222	NEW Realtree Max-4	S-XL 2XL-3XL	268.50 280.00



NEW

DIRTY BIRD VARI-TECH™ HALF BIB

- Pre-Vent® waterproof, breathable fabric • Fully-taped external seams • Vari-Tech Temperature and Motion Design • 3-layer laminate fabric throughout • High bib design back with adjustable elasticized suspender system • Fully constructed waist with partial elastic waistband • Zip-to-hip side zippers with external storm flap for easy on/off • Overlay protection on lower cuff • Articulated knees • One rear and two front zippered pockets **SIZES** S-3XL

CODE NUMBER	DESCRIPTION	SIZE	SUGG. RETAIL
30630317	NEW Mossy Oak Duck Blind	S-XL 2XL-3XL	\$221.50 233.50
30630322	NEW Realtree Max-4	S-XL 2XL-3XL	221.50 233.50



NEW



**DIRTY BIRD
SOFT SHELL PULLOVER**

- 2-layer wind-and water-resistant fabric
 - Highly breathable • Low-nap fleece inner liner with lined sleeves for easy on/off • Angle-Entry pocket design
 - Two upper handwarmer pockets
 - One zippered chest pocket • One magnetic chest pocket • Lower zippered pockets • Drawcord waist
 - Lycra® binding cuff • License tab
- SIZES S-3XL**

CODE NUMBER	DESCRIPTION	SIZE	SUGG. RETAIL
30430517	NEW Mossy Oak Duck Blind	S-XL 2XL-3XL	\$151.50 163.50
30430522	NEW Realtree Max-4	S-XL 2XL-3XL	151.50 163.50



**DIRTY BIRD
WINDKILL™ JACKET**

- 3-layer WindKill fabric blocks wind and prevents water from soaking through
 - Low-nap fleece inner liner • Lined sleeves for easy on/off • Angle-Entry pocket design
 - Two upper handwarmer pockets • One zippered pocket • One magnetic chest pocket • Lower zippered pockets • Gusseted shoulder panels for greater range of motion • Mesh lined zip pits • Adjustable, watertight laminated cuffs • Waist drawcord • Full length zipper • Stand-up, zip-through collar • License tab
- SIZES S-3XL**

NEW



CODE NUMBER	DESCRIPTION	SIZE	SUGG. RETAIL
30430617	NEW Mossy Oak Duck Blind	S-XL 2XL-3XL	\$198.50 210.00
30430622	NEW Realtree Max-4	S-XL 2XL-3XL	198.50 210.00



DIRTY BIRD WADER PANTS

- 2-layer wind- and water-resistant fabric
 - Single layer fabric below the knee to eliminate bulk in the wader • Hook and loop adjustable tabs on the cuffs tighten around the ankle for sliding into waders • Smooth shell fabric allows waders to slide on/off easy and adds range of motion while wearing with waders • Fully constructed waist with partial elastic waistband • One rear security pocket and two front pockets
- SIZES S-3XL**

CODE NUMBER	DESCRIPTION	SIZE	SUGG. RETAIL
30230517	NEW Mossy Oak Duck Blind	S-XL 2XL-3XL	\$105.00 116.50
30230522	NEW Realtree Max-4	S-XL 2XL-3XL	105.00 116.50
30230548	NEW Salt Grass	S-XL 2XL-3XL	93.00 105.00



NEW



DIRTY BIRD SMOOTHBORE IS THE PERFECT CENTERPIECE OF THE LAYERING SYSTEM.

Once you have your Dirty Bird base layers and your outer layers in hand, you'll need something to wear right in between. That's where the new Dirty Bird Smoothbore mid-layer comes in. Constructed of a mid-weight fleece with a smooth, quiet outer facing, these tops are ideal for adding warmth on colder days or they can be worn alone in milder weather.



NEW

DIRTY BIRD SMOOTHBORE FLEECE 1/4-ZIP

- Stretchable midweight fleece fabric with Smoothbore outer facing
- Angle-Entry pocket design
- Two upper handwarmer pockets
- Thumb-hole cuff design
- 1/4-zip front with stand-up, zip-through collar
- Full-length zipper guard and chin protector
- Welded shoulder pocket with zipper
- Lycra® binding waist and collar
- License tab **SIZES** S-3XL

CODE NUMBER	DESCRIPTION	SIZE	SUGG. RETAIL
30160517	NEW Mossy Oak	S-XL	\$140.00
	Duck Blind	2XL-3XL	151.50
30160522	NEW Realtree	S-XL	140.00
	Max-4	2XL-3XL	151.50



DIRTY BIRD SMOOTHBORE FLEECE HOODIE

- Stretchable midweight fleece fabric with Smoothbore outer facing
- Angle-Entry pocket design
- Two upper handwarmer pockets
- Lower kangaroo pockets
- Thumb-hole cuff design
- Attached hood with drawcord
- Welded shoulder pocket with zipper
- Lycra® binding waist
- License tab **SIZES** S-3XL

CODE NUMBER	DESCRIPTION	SIZE	SUGG. RETAIL
30160617	NEW Mossy Oak	S-XL	\$151.50
	Duck Blind	2XL-3XL	163.50
30160622	NEW Realtree	S-XL	151.50
	Max-4	2XL-3XL	163.50



NEW



NEW



DIRTY BIRD FLEECE PULLOVER

- Highly constructed microfiber fleece is wind-resistant and warm
- Angle-Entry pocket design
- Two upper handwarmer pockets
- One zippered chest pocket
- One magnetic chest pocket
- 1/4-zip front with built-in collar and hood
- Drawcord hood
- Lower kangaroo pocket
- Lycra® binding cuff
- Easy on/off sleeve lining
- License tab **SIZES** S-3XL

CODE NUMBER	DESCRIPTION	SIZE	SUGG. RETAIL
30160417	NEW Mossy Oak	S-XL	\$140.00
	Duck Blind	2XL-3XL	151.50
30160422	NEW Realtree	S-XL	140.00
	Max-4	2XL-3XL	151.50



BROWNING HAS THREE WORDS FOR COLD, WET HANDS — BYE BYE BIRDIE.

When your hands are cold and wet and your fingers feel like ten stiff icicles about to shatter all over the bottom of the duck blind, it's hard to focus on hunting. That's why we have added OutDry® technology to our most popular gloves for 2012. The problem with traditional gloves is that water gets trapped between the outer fabric shell and the waterproof interior liner. This water acts as a heat sink and quickly robs your hands of warmth, especially in cold and windy conditions. With OutDry technology, we insert a waterproof liner into the glove's outer fabric shell and then use a sophisticated heat and pressure process to fuse the liner right to the interior surface of the exterior shell. This eliminates the places where water can get trapped. Your hands stay warmer and you're able to focus on the task at hand — filling your limit of dirty birds.



DIRTY BIRD INSULATED DECOY GLOVE

NEW

- Revolutionary OutDry® membrane lamination process for 100% waterproof protection • PrimaLoft® One insulation on palm and back of hand and fingers
- Decoy length gauntlet with a unique one-handed cord lock closure • Elasticized wrist for snug fit • Overlay on palm, thumb and fingers for firm grip • Articulated fingers with Sensi-Flex trigger finger **SIZES S-XL**

CODE NUMBER	DESCRIPTION	SIZE	SUGG. RETAIL
30796017	NEW Mossy Oak Duck Blind	S-XL	\$105.00
30796022	NEW Realtree Max-4	S-XL	105.00



DIRTY BIRD GUNNERS GLOVE

NEW

- Revolutionary OutDry® membrane lamination process for 100% waterproof protection • Elasticized wrist for snug fit • Overlay on palm, thumb and fingers for firm grip • Articulated fingers with Sensi-Flex trigger finger **SIZES S-XL**

CODE NUMBER	DESCRIPTION	SIZE	SUGG. RETAIL
30796117	NEW Mossy Oak Duck Blind	S-XL	\$93.00
30796122	NEW Realtree Max-4	S-XL	93.00



DIRTY BIRD INSULATED GLOVE

NEW

- Revolutionary OutDry® membrane lamination process for 100% waterproof protection • PrimaLoft® One insulation on palm back of hand and fingers
- Elasticized wrist for snug fit • Overlay on palm, thumb and fingers for firm grip **SIZES S-XL**

CODE NUMBER	DESCRIPTION	SIZE	SUGG. RETAIL
30796217	NEW Mossy Oak Duck Blind	S-XL	\$93.00
30796222	NEW Realtree Max-4	S-XL	93.00



NEW

PRIMALOFT LINER JACKET

- PrimaLoft Sport insulation offers optimum warmth without bulk • Featherweight shell and lining fabrics for packability • Zippered chest pocket doubles as stuff bag • Two zippered handwarmer pockets with zipper closures • Bottom drawcord adjusts from inside handwarmer pockets • Inside security pocket with zippered closure **SIZES** S-3XL

CODE NUMBER	DESCRIPTION	SIZE	SUGG. RETAIL
30489820	NEW Mossy Oak Break-Up Infinity	S-XL 2XL-3XL	\$140.00 151.50
30489821	NEW Realtree AP	S-XL 2XL-3XL	140.00 151.50
30489817	NEW Mossy Oak Duck Blind	S-XL 2XL-3XL	140.00 151.50
30489822	NEW Realtree Max-4	S-XL 2XL-3XL	140.00 151.50
30489848	NEW Salt Grass	S-XL 2XL-3XL	116.50 128.50



Jacket shown stuffed into its own pocket

PRIMALOFT — WARMER, DRIER, SOFTER.

Looks can be deceiving. At first glance our clothing with PrimaLoft insulation looks much like any other insulated clothing. In reality, it is much more. The combination of superfine PrimaLoft Sport insulation and highly-constructed shell and lining fabrics provide unbelievable warmth with minimal weight or bulk. Unlike down, PrimaLoft Sport continues to insulate even when wet, and dries incredibly fast. When you layer it under a waterproof shell, it offers outstanding protection from cold, wet weather. Because of its lightweight comfort and warmth, you may find yourself wearing it alone in less demanding weather. The liner jacket and vest can stuff into the chest pocket for storage. The new pant has a stuff bag for storage.



NEW

PRIMALOFT VEST

- PrimaLoft Sport insulation offers optimum warmth without bulk • Featherweight shell and liner fabric • Zippered chest pocket doubles as a stuff bag • Two zippered handwarmer pockets • Drawcord waist • Stand-up collar **SIZES** S-3XL

CODE NUMBER	DESCRIPTION	SIZE	SUGG. RETAIL
30589848	NEW Salt Grass	S-XL 2XL-3XL	\$93.00 105.00



NEW

PRIMALOFT PANT

- PrimaLoft Sport insulation provides warmth without bulk • Featherweight shell and lining fabrics for packability • Elasticized waist with drawcord adjustment for perfect fit • Zippered fly • Tailored cut to fit well under outer layer • Zippered cuff opening with stirrups to prevent them from riding up **SIZES** S-3XL

CODE NUMBER	DESCRIPTION	SIZE	SUGG. RETAIL
30289848	NEW Salt Grass	S-XL 2XL-3XL	\$105.00 116.50



Pant shown stuffed into its own stuff bag





FULL CURL WOOL 3-IN-1 PARKA

7 oz. wool blend • WindKill™ laminate blocks wind and provides water resistance in all but the most extreme weather • Removable down vest • Soft tricot lining • Breathable fleece side panels • Washable • Two upper zippered slash pockets • Two lower bellows pockets with snap closures • Two handwarmer pockets • Zip-off hood • Zip-through collar • Longer parka length • Adjustable cuffs • External storm flap • Browning AllTerrain camouflage pattern

SIZES S-3XL



WINDKILL LAMINATE

DETACHABLE HOOD

REMOVABLE DOWN VEST LINER

ZIPPERED SLASH POCKETS

BELLOWS POCKETS

FLEECE SIDES

CODE NUMBER	DESCRIPTION	SIZE	SUGG. RETAIL
30319829	AllTerrain	S-XL	\$290.00
		2XL-3XL	304.00



FULL CURL WOOL BIB

7 oz. wool blend • WindKill™ laminate blocks wind and provides water resistance in all but the most extreme weather • Soft tricot lining • Washable • Zip-to-knee cuff openings with storm flaps • Elasticized suspenders with cam lock buckles • One front zippered pocket • Zippered front opening with two-way zipper and storm flap • Browning AllTerrain camouflage pattern **SIZES S-3XL**

CODE NUMBER	DESCRIPTION	SIZE	SUGG. RETAIL
30619829	AllTerrain	S-XL	\$233.50
		2XL-3XL	245.00





FULL CURL WOOL JACKET

7 oz. wool blend • WindKill™ laminate blocks wind and provides water resistance in all but the most extreme weather • Soft tricot lining • Breathable fleece side panels • Washable • Two upper zippered slash pockets • Two handwarmer pockets • Zip-through collar • Adjustable cuffs • Browning AllTerrain camouflage pattern **SIZES** S-3XL

CODE NUMBER	DESCRIPTION	SIZE	SUGG. RETAIL
30419829	AllTerrain	S-XL 2XL-3XL	\$178.00 190.00



FULL CURL WOOL — THE EVOLUTION OF NATURE'S MOST FUNCTIONAL FABRIC.

First there was wool, supremely versatile yet itchy. Then came non-itch wool blends that were just as versatile but more comfortable to wear. Now, we have taken wool to an even higher level with Full Curl Wool, and this wonder fabric has never been more comfortable and effective against the elements. Full Curl combines a durable 7 oz. wool blend outer fabric with WindKill™ windproof and water-resistant lamination and soft tricot lining for the ultimate wool fabrication. Fleece side panels are added to increase breathability. The 3-in-1 Parka relies upon another of nature's wonders — goose down — to provide insulation in the removable down vest. The rugged, time-honored performance of wool makes the Full Curl ideal for nearly all conditions, terrains and activity levels.

FULL CURL WOOL PANT

7 oz. wool blend • WindKill™ laminate blocks wind and provides water resistance in all but the most extreme weather • Soft tricot liner • Washable • Six pocket design • Drawstring cuffs • Button closures on rear and cargo pockets • Browning AllTerrain camouflage pattern **SIZES** S-3XL

CODE NUMBER	DESCRIPTION	SIZE	SUGG. RETAIL
30219829	AllTerrain	S-XL 2XL-3XL	\$164.00 178.00



FULL CURL WOOL BASE LAYER TOP

- Comfortable, no-itch Merino wool blend construction
- Breathable polyester side panels
- Odor reduction from natural anti-microbial properties of wool
- Self fabric neck and cuffs
- Mock neck or quarter-zip models available

SIZES S-3XL

CODE NUMBER	DESCRIPTION	SIZE	SUGG. RETAIL
30119929	Mock Neck Loden	S-XL	\$63.00
		2XL-3XL	70.00
30119129	Quarter-Zip Loden	S-2XL	63.00
		2XL-3XL	70.00



FULL CURL WOOL BASE LAYER BOTTOM

- Comfortable, no-itch Merino wool blend construction
- Odor reduction from natural anti-microbial properties of wool
- Self fabric cuffs
- Elastic waistband
- Fly opening

SIZES S-3XL

CODE NUMBER	DESCRIPTION	SIZE	SUGG. RETAIL
30219929	Loden	S-XL	\$63.00
		2XL-3XL	70.00



FULL CURL WOOL SWEATER — PERFECT FOR NEARLY ALL CONDITIONS.

Simple and versatile, a Full Curl Wool sweater is a must for every serious hunter. It is a warm and insulating layer, even if it gets wet. It is also breathable. And with windproof WindKill™ the Full Curl Wool Sweater becomes a great choice as an outer piece. Unlike wool sweaters of yesteryear, the Full Curl Sweater with WindKill features an itch-free lining to keep you comfortable.



FULL CURL WOOL SWEATER

- Wool/acrylic blend knit fabric
- Available with soft poly tricot lining with WindKill™ windproof lamination
- Knit construction
- Four-button front
- Also available without WindKill **SIZES** S-3XL

CODE NUMBER	DESCRIPTION	SIZE	SUGG. RETAIL
30020229	AllTerrain	S-XL	\$92.00
		2XL-3XL	104.00
30020329	AllTerrain w\ WindKill	S-XL	104.00
		2XL-3XL	116.00



FULL CURL WOOL BEANIE

- Wool/acrylic blend knit fabric
- Soft poly tricot lining with WindKill™ windproof lamination
- One-piece knit construction
- Stretch fit **SIZES** One size fits most

CODE NUMBER	DESCRIPTION	SIZE	SUGG. RETAIL
30827829	AllTerrain	one size	\$23.00



FULL CURL WOOL — AND FOR HER.

Full Curl Wool For Her offers the same features as the men’s versions, with a cut tailored to fit the ladies. Soft, quiet and warm, there is no more natural way to enjoy nature than with our Full Curl Wool For Her.



FULL CURL WOOL PARKA FOR HER

- 7 oz. wool blend • WindKill™ laminate blocks wind and provides water resistance in all but the most extreme weather • Soft tricot lining • Breathable fleece side panels • Washable • Two upper pockets • Two lower bellows pockets with snap closures • Two handwarmer pockets • Zip-off hood • Zip-through collar • Longer parka length • Adjustable cuffs • External storm flap • Browning AllTerrain camouflage pattern • Specially cut for ladies • Pink Buckmark embroidery **SIZES** S-2XL

CODE NUMBER	DESCRIPTION	SIZE	SUGG. RETAIL
30318829	AllTerrain	S-2XL	\$164.00



FULL CURL WOOL PANT FOR HER

- 7 oz. wool blend • WindKill™ laminate blocks wind and provides water resistance in all but the most extreme weather • Soft tricot lining • Washable • Six pocket design • Button closures on rear and cargo pockets • Side tab waist adjustment • Browning AllTerrain camouflage pattern • Specially cut for ladies • Pink Buckmark embroidery **SIZES** S-2XL

CODE NUMBER	DESCRIPTION	SIZE	SUGG. RETAIL
30218829	AllTerrain	S-2XL	\$116.50



WASATCH — RUGGED COMFORT.

Wasatch Fieldwear is much more than just another line of camo clothing. Multiple pockets, a loose cut for freedom of movement and a durable cotton-rich fabric that breathes freely are notable additions that break Wasatch out of the crowd. Wasatch Fieldwear is a value-packed addition to your gear collection.



NEW



NEW



WASATCH SHIRTS

- 7 oz., 55% cotton, 45% polyester twill fabric
 - Seven-button front with long tails
 - Double pleated back for full range of motion
 - Button-down collar
 - Double-needle side seam construction
 - Adjustable button cuffs and longer sleeve plackets for easier roll-up
- SIZES S-3XL**



CODE NUMBER	DESCRIPTION	SIZE	SUGG. RETAIL
30113520	Mossy Oak Break-Up Infinity	S-XL 2XL-3XL	\$38.00 44.50
30113517	Mossy Oak Duck Blind	S-XL 2XL-3XL	38.00 44.50
30113519	Mossy Oak Bottomland	S-XL 2XL-3XL	38.00 44.50
30113521	NEW Realtree AP	S-XL 2XL-3XL	38.00 44.50
30113523	NEW Realtree Max-1	S-XL 2XL-3XL	38.00 44.50
30113522	NEW Realtree Max-4	S-XL 2XL-3XL	38.00 44.50

WASATCH PANTS

- 7 oz., 55% cotton, 45% polyester twill
 - Deep front pockets
 - Oversized side cargo pockets with flap and button closure
 - Drawcord cuffs for snug fit around boots
 - Adjustable waist tabs for comfortable fit
 - Rear flap button-through pockets
- SIZES S-3XL INSEAM LENGTHS S-L 32½", XL-3XL 33½"**

CODE NUMBER	DESCRIPTION	SIZE	SUGG. RETAIL
30213520	Mossy Oak Break-Up Infinity	S-XL 2XL-3XL	\$38.00 44.50
30213517	Mossy Oak Duck Blind	S-XL 2XL-3XL	38.00 44.50
30213519	Mossy Oak Bottomland	S-XL 2XL-3XL	38.00 44.50
30213521	NEW Realtree AP	S-XL 2XL-3XL	38.00 44.50
30213523	NEW Realtree Max-1	S-XL 2XL-3XL	38.00 44.50
30213522	NEW Realtree Max-4	S-XL 2XL-3XL	38.00 44.50





WASATCH CHAMOIS SHIRT

- 9 oz., 100% cotton chamois • Seven-button front with long tails • Double pleated back • Button-down collar
 - Double-needle side seam construction • Adjustable button cuffs and longer sleeve plackets for easier roll-up
- SIZES S-3XL**

CODE NUMBER	DESCRIPTION	SIZE	SUGG. RETAIL
30113420	Mossy Oak Break-Up Infinity	S-XL 2XL-3XL	\$63.50 70.00
30113421	NEW Realtree AP	S-XL 2XL-3XL	63.50 70.00



WASATCH CHAMOIS PANT

- 9 oz., 100% cotton chamois • Deep front pockets
 - Oversized side cargo pockets with flap and button closure • Drawcord cuffs for snug fit around boots
 - Adjustable waist tabs for comfortable fit • Rear flap button-through pockets
- SIZES S-3XL**

INSEAM LENGTHS S-L 32½", XL-3XL 33½"

CODE NUMBER	DESCRIPTION	SIZE	SUGG. RETAIL
30213420	Mossy Oak Break-Up Infinity	S-XL 2XL-3XL	\$63.50 70.00
30213421	NEW Realtree AP	S-XL 2XL-3XL	63.50 70.00

VAPOR MAX TAKES COMFORT AND ODOR CONTROL TO THE MAX.

Vapor Max combines a comfortable 100% polyester wicking fabric with OdorSmart™ silver ion anti-microbial treatment. OdorSmart helps control human odors to give you the edge on the keen noses of wary game. Available with a crew neck in both short sleeve and long sleeve variations, it dries quickly after exertion and keeps you comfortable in any condition.



VAPOR MAX SHORT SLEEVE T-SHIRT

- 100% Polyester Vapor Max fabric • Transfers moisture away from your body • Quick drying and evaporating • OdorSmart™ technology featuring VisaEndurance® silver ion anti-microbial technology • Crew neck • Short sleeve
- SIZES S-3XL**

CODE NUMBER	DESCRIPTION	SIZE	SUGG. RETAIL
30115120	NEW Mossy Oak Break-Up Infinity	S-XL 2XL-3XL	\$31.50 38.00
30115117	NEW Mossy Oak Duck Blind	S-XL 2XL-3XL	31.50 38.00
30115121	NEW Realtree AP	S-XL 2XL-3XL	31.50 38.00
30115122	NEW Realtree Max-4	S-XL 2XL-3XL	31.50 38.00



VAPOR MAX LONG SLEEVE T-SHIRT

- 100% Polyester Vapor Max fabric • Transfers moisture away from your body • Quick drying and evaporating • OdorSmart™ technology featuring VisaEndurance® silver ion anti-microbial technology • Crew neck • Long sleeve
- SIZES S-3XL**

CODE NUMBER	DESCRIPTION	SIZE	SUGG. RETAIL
30116120	NEW Mossy Oak Break-Up Infinity	S-XL 2XL-3XL	\$38.00 44.50
30116117	NEW Mossy Oak Duck Blind	S-XL 2XL-3XL	38.00 44.50
30116121	NEW Realtree AP	S-XL 2XL-3XL	38.00 44.50
30116122	NEW Realtree Max-4	S-XL 2XL-3XL	38.00 44.50



WASATCH — RUGGED COMFORT FOR ALL.

Wasatch Fieldwear is the most comfortable, best-built camo clothing around and it's available for the whole family. Ladies and young hunters alike can enjoy the same rugged, easy-wearing Wasatch Fieldwear as men, complete with all the conveniences that make Wasatch Fieldwear better than the rest.



WASATCH SHIRT FOR HER

- 7 oz., 55% cotton, 45% poly twill fabric • Button front design
- Double pleated back design • Open collar • Adjustable button cuffs and sleeves • Ladies' cut • Pink trim fabric

SIZES S-XL

CODE NUMBER	DESCRIPTION	SIZE	SUGG. RETAIL
30116420	Mossy Oak Break-Up Infinity	S-XL	\$38.00
30116421	NEW Realtree AP	S-XL	38.00



WASATCH PANT FOR HER

- 7 oz., 55% cotton, 45% poly twill fabric • Deep front pockets
- Oversized cargo pockets • Drawcord cuffs • Adjustable waist tab • Ladies' cut • Pink trim fabric

SIZES S-XL

CODE NUMBER	DESCRIPTION	SIZE	SUGG. RETAIL
30216420	Mossy Oak Break-Up Infinity	S-XL	\$38.00
30216421	NEW Realtree AP	S-XL	38.00



JUNIOR WASATCH PANT

- 7 oz., 55% cotton, 45% poly twill fabric • Deep front pockets • Oversized cargo pockets • Drawcord cuffs
- Adjustable waist tab • Junior cut

CODE NUMBER	DESCRIPTION	SIZE	SUGG. RETAIL
30219020	Mossy Oak Break-Up Infinity	S-XL	\$38.00
30219021	NEW Realtree AP	S-XL	38.00



JUNIOR WASATCH SHIRT

- 7 oz., 55% cotton, 45% poly twill fabric • Button front design • Double pleated back design • Button down collar
- Adjustable button cuffs and sleeves • Junior cut

CODE NUMBER	DESCRIPTION	SIZE	SUGG. RETAIL
30119020	Mossy Oak Break-Up Infinity	S-XL	\$38.00
30119021	NEW Realtree AP	S-XL	38.00



WASATCH INSULATED JACKET

• 7 oz. cotton/poly twill shell fabric • Brushed tricot lining
 • Smooth taffeta sleeve lining for easy on/off • SelectWeight™
 insulation • Large front pockets with snap closures • Drawcord
 hood • Rib knit cuffs and elastic waistband **SIZES** S-3XL

CODE NUMBER	DESCRIPTION	SIZE	SUGG. RETAIL
30413720	Mossy Oak Break-Up Infinity	S-XL 2XL-3XL	\$89.00 95.50
30413721	NEW Realtree AP	S-XL 2XL-3XL	89.00 95.50



WASATCH — A STYLE FOR EVERY NEED.

Wasatch Fieldwear is the finest line of camo clothing available. The foundation is the rugged, breathable, fabric that moves with you. In addition to our popular core products, we also have a line of insulated jackets and bibs, all designed to keep you comfortable when the temperatures dip.



NEW

WASATCH INSULATED BIB

• 7 oz. cotton/poly • Smooth taffeta lining • Zip-to-hip side openings with storm flaps • Elasticized suspenders with cam lock buckles • One front zippered pocket • Zippered front opening with two-way zipper and storm flap **SIZES** S-3XL

CODE NUMBER	DESCRIPTION	SIZE	SUGG. RETAIL
30613520	NEW Mossy Oak Break-Up Infinity	S-XL 2XL-3XL	\$114.50 127.00
30613521	NEW Realtree AP	S-XL 2XL-3XL	114.50 127.00



NEW

JUNIOR WASATCH JACKET

• 7 oz. cotton/poly twill shell fabric • Brushed tricot lining
 • Smooth taffeta sleeve lining for easy on/off • SelectWeight™
 insulation • Large front pockets with snap closures • Partial
 elasticized hood • Rib knit cuffs and elastic waistband **SIZES** S-XL

CODE NUMBER	DESCRIPTION	SIZE	SUGG. RETAIL
30413820	Mossy Oak Break-Up Infinity	S-XL	\$70.00
30413821	NEW Realtree AP	S-XL	70.00





BIG COUNTRY VEST

• 100% polyester fabric • Quiet and durable construction • Reinforced outer seams for durability • Quilted shoulder overlays • Advanced pocket design for carrying accessories **SIZES** S-3XL

CODE NUMBER	DESCRIPTION	SIZE	SUGG. RETAIL
30541501	Blaze	S-3XL	\$76.00



SAFETY VEST

• 100% polyester oxford • Zip front • Back license loop • Large snap flap shell pockets • Buckmark embroidery on front and back **SIZES** S-3XL

CODE NUMBER	DESCRIPTION	SIZE	SUGG. RETAIL
SAFETY VEST			
30510001	Blaze	S-3XL	\$20.00
JUNIOR SAFETY VEST			
30550001	Blaze	S-XL	18.00



JUNIOR SAFETY VEST

• 100% polyester oxford • Zip front • Back license loop • Large snap flap shell pockets • Buckmark embroidery on front and back • Cut specifically for junior builds **SIZES** S (6-8), M (10-12), L (14-16), XL (18-20)



Zip-off sleeves



Bellows pockets with Pocket Expander System

PHEASANTS FOREVER ZIP-OFF SLEEVE JACKET

• 12 oz., 100% cotton canvas • 100% polyester blaze overlay — over 400 square inches • Zip-off sleeves convert jacket into a vest • Available with Pheasants Forever embroidery • Large bloodproof front load game bag with zip opening for easy cleaning • Shell pockets with the Pocket Expander System for easy conversion to exposed shell loops • Hook and loop pocket flap for easy shell pocket access • D-rings for dog training accessories • Corduroy lined collar • Two zippered front pockets • Two-way front zipper with snap storm flap • Adjustable cuffs • REACTAR™ G2 pad pocket behind each shoulder patch (pad sold separately) **SIZES S-3XL**

CODE NUMBER	DESCRIPTION	SIZE	SUGG. RETAIL
30411632	Field Tan, with Pheasants Forever logo embroidery	S-XL 2XL-3XL	\$118.50 130.50
30411932	Field Tan, without embroidery	S-XL 2XL-3XL	118.50 130.50

PHEASANTS FOREVER — JOIN THE CAUSE.

Without the conservation efforts of Pheasants Forever, millions of acres of prime pheasant habitat would be lost. Pheasants Forever chapters all over the United States work to protect, restore and enhance wildlife habitat by establishing and maintaining local and regional projects. From encouraging farmers to leave longer wheat stubble, to the purchase of upland habitat land, Pheasants Forever continues to work to preserve America's favorite game bird. To become a member or volunteer, please call toll free (877) 773-2070. With every purchase of a Browning Pheasants Forever product, we proudly makes a contribution to this most worthy conservation organization.





REACTAR G2



PHEASANTS FOREVER VEST

- 12 oz., 100% cotton canvas • Bloodproof game bag with zip opening
- Available with Pheasants Forever embroidery • Shell pockets with the Pocket Expander System for easy conversion to exposed shell loops
- Two zippered front pockets • Zipper front • D-rings for dog training accessories • REACTAR™ G2 pad pocket behind each shoulder patch (pad sold separately) **SIZES** S-3XL

CODE NUMBER	DESCRIPTION	SIZE	SUGG. RETAIL
30511632	Field Tan, with Pheasants Forever logo embroidery	S-XL 2XL-3XL	\$83.00 95.00
30511932	Field Tan, without embroidery	S-XL 2XL-3XL	83.00 95.00



PHEASANTS FOREVER STRAP VEST

- Mesh-back game bag with a breathable, bloodproof laminate in the game bag • Shell pockets with the Pocket Expander System for easy conversion to exposed shell loops • Adjustable shoulder straps
- Adjustable front belt with speed buckle • Side adjustment straps
- Available with Pheasants Forever embroidery **SIZES** One size fits most

CODE NUMBER	DESCRIPTION	SIZE	SUGG. RETAIL
30511732	Field Tan, with Pheasants Forever logo embroidery	one size	\$71.00
30512032	Field Tan, without embroidery	one size	71.00



IS YOUR UPLAND CLOTHING UP TO SNUFF?

Pheasants Forever is an organization that has brought upland to the forefront of hunting in America today. Show your loyalty and enjoy lots of all-day comfort with our Pheasants Forever 100% cotton canvas bird vests, jackets, chaps and pants. Bust some brush and bust some birds in our Pheasants Forever hunting clothing.

PHEASANTS FOREVER CHAPS

- 12 oz., 100% cotton canvas • Briar-resistant overlay
 - Double sized adjustment loops with hook and loop closures • Snap side opening for easy on and off
 - Available with Pheasants Forever embroidery
- INSEAM LENGTHS** 28" Regular, 31" Tall

CODE NUMBER	DESCRIPTION	SIZE	SUGG. RETAIL
30011632	Field Tan, with Pheasants Forever logo embroidery	28" Inseam	\$63.50
		31" Inseam	70.00
30011932	Field Tan, without embroidery	28" Inseam	63.50
		31" Inseam	70.00

PHEASANTS FOREVER PANTS

- 12 oz., 100% cotton canvas • Briar-resistant overlay
 - Comfortable, work pant style fit • Deep front pockets
 - Tool pockets on legs • Zipper fly • Flap rear pockets
 - Available with Pheasants Forever embroidery
- SIZES** Waist 32"- 44" **INSEAM LENGTHS** 30", 32"

CODE NUMBER	DESCRIPTION	SIZE	SUGG. RETAIL
30211632	Field Tan, with Pheasants Forever logo embroidery	30" Inseam	\$76.00
		32" Inseam	
30211932	Field Tan, without embroidery	30" Inseam	76.00
		32" Inseam	



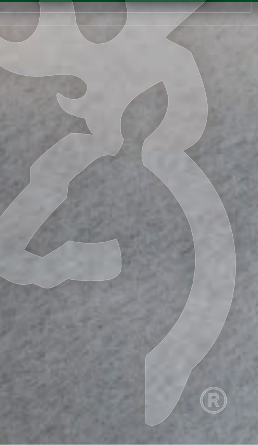

Bird'n Lite®



WIDE NYLON SHOULDER STRAPS TRANSFER THE LOAD TO YOUR SHOULDERS, YET STILL LET YOU SWING THROUGH THE BIRD NATURALLY

THE QUICK-RELEASE STERNUM STRAP HELPS KEEP THE WEIGHT CENTERED BETWEEN YOUR SHOULDERS FOR IMPROVED BALANCE AND LESS FATIGUE

BIRD'N LITE — WHERE TRADITION AND INNOVATION COME TOGETHER.

Upland hunters are immersed in tradition. It's all about being afield with a good dog, a well-traveled Citori and feeling the heft of shells and birds swinging in your favorite vest. Now's the time to upgrade your upland gear and check out our Bird'n Lite series. Bird'n Lite Jackets and Vests feature an integrated load-bearing system that lifts the load higher and balances it between your shoulders and hips for more comfort and stability, all without sacrificing the look of traditional upland hunting gear. With Bird'n Lite, you can carry more, with less effort, for far longer than you would ever have wanted to with your old hunting vest. Start a new tradition with our Bird'n Lite Jackets and Vests. See the entire Bird'n Lite System in action at browning.com.

THE FULLY-ADJUSTABLE LOAD BEARING STRAPS LET YOU PLACE YOUR LOAD'S CENTER OF GRAVITY WHERE IT'S MOST COMFORTABLE TO CARRY

ERGONOMICALLY-CONTOURED, PADDED ADJUSTABLE WAIST BELT OFFERS ADDED SUPPORT TO YOUR LOWER BACK AND ALLOWS PART OF THE LOAD TO BE CARRIED ON YOUR HIPS FOR GREATER COMFORT

QUICK-RELEASE COMPOSITE BUCKLE ALLOWS FOR QUICK ON AND OFF, BOTH AT THE TRUCK OR IN THE FIELD

Bird'n Lite®

BIRD'N LITE JACKET — YOU'LL NEVER GO AFIELD WITHOUT IT.

Now you can have the best of both worlds — a state-of-the-art load carrying system built right into a traditional looking jacket you'll be proud to wear afield. Bird'n Lite Jackets lift your load higher and let you select the ideal balance point between your shoulders and hips for both comfort and stability. The blaze orange shoulder and sleeve overlays let other hunters know exactly where you are, while the traditional khaki body helps hide the smudges and scuffs that are part of every upland hunt. The bloodproof game bag is easy to access, and there are pockets galore for every item you might want to take into the field. When you're ready to load up and move out on your next upland hunt, you're ready for a Browning Bird'n Lite Jacket.



STERNUM STRAP
KEEPS SHOULDER
STRAPS IN PLACE

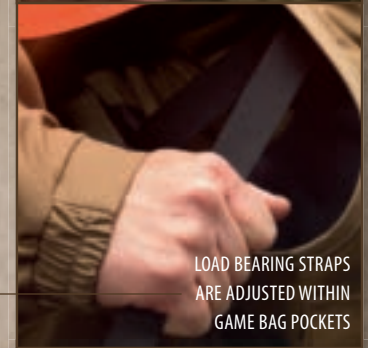

LOAD BEARING STRAPS
ARE ADJUSTED WITHIN
GAME BAG POCKETS

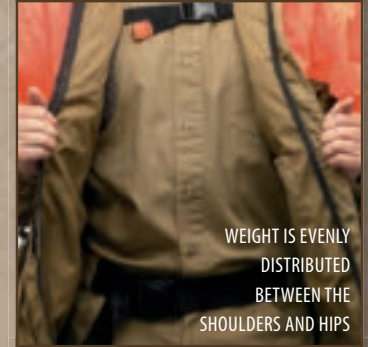

WEIGHT IS EVENLY
DISTRIBUTED
BETWEEN THE
SHOULDERS AND HIPS



ADJUSTABLE WAIST
BELT SECURES THE
LOAD TO YOUR HIPS

BROWNING BIRD'N LITE JACKET

- Browning Bird'n Lite Technology weight distribution system secures your load • Rugged, lightweight cotton/polyester shell fabric • Blaze shoulder overlays • Front-loading bloodproof game bag with zip-top opening and load stabilizing strap • Oversized shell pockets with internal shell loops and snap closures • Built-in rucksack with elastic top and buckle strap closure • Zipper front • Transmitter pocket with antenna loop • REACTAR™ G2 pad pockets behind each quilted shoulder patch (pad sold separately) • Lined handwarmer pockets behind shell pockets • Water bottle pockets • D-rings for accessories • Hook and loop adjustable elastic cuffs • Available with Pheasants Forever embroidery • Zip-through collar • License tab **SIZES** S-3XL

CODE NUMBER	DESCRIPTION	SIZE	SUGG. RETAIL
30468958	Khaki/Blaze, with Pheasants Forever embroidery	S-XL 2XL-3XL	\$175.00 186.50
30468858	Khaki/Blaze, without embroidery	S-XL 2XL-3XL	175.00 186.50



BIRD'N LITE VEST — THE FINEST FOR THE FIELD.

If covering miles of open ground laden with shells, birds, water, lunch, a jacket, training transmitters and all the sundry items you need in the field make you think you need a backpack instead of an upland vest, take a look at our Bird'n Lite Strap Vest. This innovative vest utilizes the patented Bird'n Lite Technology load bearing system that secures and distributes the weight of heavy loads, making walking all those miles much more comfortable. Gone are the days of heavy, swinging game bags, picking wet feathers off your water bottle and rubbing sore shoulders. Hitch up a Bird'n Lite Strap Vest and enjoy hunting all over hill and dale.

Bird'n Lite®



BROWNING BIRD'N LITE STRAP VEST

- Browning Bird'n Lite Technology weight distribution system secures your load
- Rugged, lightweight cotton/polyester shell fabric • Padded blaze shoulder straps
- Front-loading bloodproof game bag with load stabilizing strap • Oversized shell pockets with internal shell loops and snap closures • Built-in rucksack with elastic top
- Adjustable belt • Lined handwarmer pockets behind shell pockets • Water bottle pockets • Available with Pheasants Forever embroidery **SIZES** M/L, XL/2XL

CODE NUMBER	DESCRIPTION	SIZE	SUGG. RETAIL
30068958	Khaki/Blaze, with Pheasants Forever embroidery	M/L, XL/2XL	\$140.00
30068858	Khaki/Blaze, without embroidery	M/L, XL/2XL	140.00





BROWNING BIRD'N LITE VEST

- Browning Bird'n Lite Technology weight distribution system secures your load
- Rugged, lightweight cotton/polyester shell fabric
- Blaze shoulder overlays
- Front-loading bloodproof game bag with zip-top opening and load stabilizing strap
- Oversized shell pockets with internal shell loops and snap closures
- Built-in rucksack with elastic top
- Zipper front
- Transmitter pocket with antenna loop
- REACTAR™ G2 pad pockets behind each

quilted shoulder patch (pad sold separately) • Lined handwarmer pockets behind shell pockets • Water bottle pockets • D-rings for accessories • Available with Pheasants Forever embroidery • License tab **SIZES** S-3XL

REACTAR G2

CODE NUMBER	DESCRIPTION	SIZE	SUGG. RETAIL
30568958	Khaki/Blaze, with Pheasants Forever embroidery	S-XL 2XL-3XL	\$140.00 151.50
30568858	Khaki/Blaze, without embroidery	S-XL 2XL-3XL	140.00 151.50

BROWNING BIRD'N LITE PANT

- Rugged, lightweight cotton/polyester shell fabric
- Briar-resistant nylon overlays on front face and back calf
- Comfortable, relaxed fit
- Boot cut for easy fit over boots
- Zipper fly
- Flap rear pockets with snap closures
- Available with Pheasants Forever embroidery

SIZES S-3XL

CODE NUMBER	DESCRIPTION	SIZE	SUGG. RETAIL
30268958	Khaki, with Pheasants Forever embroidery	S-3XL	\$93.00
30268858	Khaki, without embroidery	S-3XL	93.00



BIRD'N LITE VEST AND PANT — COMPLETE YOUR HUNTING OUTFIT.

Complete your ensemble with the Bird'n Lite Vest and Pant. The vest offers all the latest Bird'n Lite features in a comfortable, more traditionally-styled upland bird vest. The pants have a relaxed fit for all-day comfort and are constructed of rugged poly/cotton twill with briar-resistant nylon overlays front and back. A zipper fly and snap-button flaps on the rear pockets make them a perfect pair of pants for upland game. Both the Bird'n Lite Vest and Pant are available with Pheasants Forever embroidery.

Bird'n Lite®



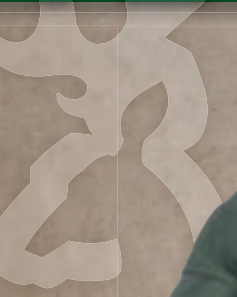

CROSS COUNTRY WINDKILL™ JACKET

• 3-layer, 4-way stretch fabric features a hard-faced, abrasion-resistant nylon shell, windproof and water-repellent WindKill™ laminate middle layer, and soft fleece lining • Highly breathable • Underarm ventilation zippers regulate heat • Two slash pockets, two chest pockets • Drawcord waist • Full-length zipper • Stand-up collar **SIZES** S-3XL



CODE NUMBER	DESCRIPTION	SIZE	SUGG. RETAIL
30413040	Khaki/Loden	S-XL	\$140.00
		2XL-3XL	151.50



CROSS COUNTRY UPLAND SHIRT

• 100% polyester fabric moves moisture away from the body • Blaze or Loden overlays and shoulder patch • REACTAR™ G2 pad pocket (pad sold separately) • Angled front pocket **SIZES** S-3XL

CODE NUMBER	DESCRIPTION	SIZE	SUGG. RETAIL
30119358	Khaki/Blaze	S-XL	\$55.00
		2XL-3XL	60.00
30119340	Khaki/Loden	S-XL	55.00
		2XL-3XL	60.00

REACTAR G2





CROSS COUNTRY PRO UPLAND JACKET

- 160 denier nylon shell with water-resistant, windproof lining • OverCast barrier design for water-resistant and windproof protection • Fully-taped seams on shoulders, collar and armholes for added waterproof protection • Brushed tricot body and sleeve lining for easy on and off • Full-length zipper with external storm flap
- Blaze shoulder overlays • Articulated shoulders for ease of movement
- REACTAR™ G2 pad pockets behind both shoulders (pad sold separately) • Front-loading bloodproof game bag with drain holes and zip-top opening • Fleece-lined collar • Two inverted-pleat bellows pockets with magnetic flap closures, elastic gussets for easy pocket expansion and shell loops • Lined handwarmer pockets on chest and behind bellows pockets • Attached hood zips into collar
- Hook and loop adjustable, water-resistant cuffs • Water bottle pockets • Internal security pockets **SIZES S-3XL**

CODE NUMBER	DESCRIPTION	SIZE	SUGG. RETAIL
30414858	Khaki/Blaze	S-XL 2XL-3XL	\$116.00 128.00



Hood zips into collar

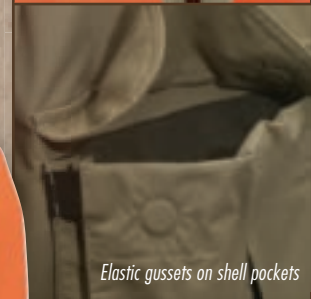

Elastic gussets on shell pockets



Articulated shoulders

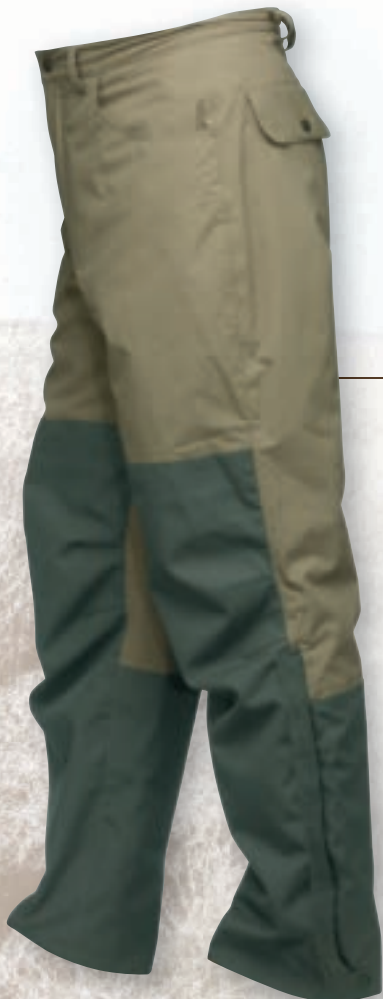

CROSS COUNTRY PRO UPLAND PANT

- 160 denier nylon shell with water-resistant, windproof lining • OverCast barrier design for water-resistant and windproof protection • Fully-taped seams • Taffeta leg lining for easy on and off • Briar-resistant nylon oxford overlays on front face and back calf • Comfortable, relaxed fit • Boot cut for easy fit over boots • Zipper fly • Flap rear pockets with snap closures • Fully-constructed waistband with kidney flap • Zip-to-knee leg openings with storm flaps • Articulated knees
- Two front pockets **SIZES S-3XL**

CODE NUMBER	DESCRIPTION	SIZE	SUGG. RETAIL
30214858	Khaki/Olive	S-XL 2XL-3XL	\$84.00 90.00



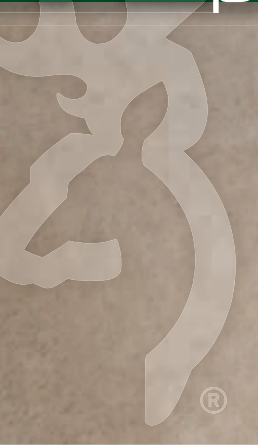

**UPLAND SHIRTS —
COMFORTABLE FIT FOR
DAY-LONG PERFORMANCE.**

Countless hours in the field have yielded a line-up of shirts designed to take comfort and durability to the next level. Our upland shirts provide you with easy mobility and a bind-free fit when shouldering a shotgun and swinging on game. Of course, these shirts are also stylish and look great when worn at your range or club.

**PRAIRIELANDS CANVAS
OVERLAY SHIRT**

- 100% cotton sandwashed canvas • Bi-swing action back for comfort and mobility
- Flap-closure pleated chest pocket • Mossy Oak® camo overlays • REACTAR™ G2 pad pocket (pad sold separately) • Antique brass logo snaps • Spread collar **SIZES** S-3XL

CODE NUMBER	DESCRIPTION	SIZE	SUGG. RETAIL
30111214	Dark Khaki/New Break-Up	S-XL 2XL-3X	\$61.00 67.50



PRAIRIELANDS UPLAND SHIRT

- 100% cotton canvas • Contrasting sleeve and shoulder
- Bi-swing action back for comfort and mobility • Chest pocket • REACTAR™ G2 pad pocket (pad sold separately)
- Padded shoulder patch • Longer sleeve placket for easy roll-up • Button-down collar **SIZES** S-3XL

CODE NUMBER	DESCRIPTION	SIZE	SUGG. RETAIL
30113742	Acorn/Olive	S-XL 2XL-3XL	\$58.00 64.00

PRAIRIELANDS BELTED GAME BAG

- 100% cotton canvas with rubberized mesh pocket to cool game
- Extra pockets for choke tubes, sunglasses or dog training transmitter • Pocket for optional 1.5 liter hydration bladder
- Game bag has bloodproof lining and mesh sides • Leather belt with brass buckle **SIZES** M (34"-38"), L (38"-43"), XL (44"-49")

CODE NUMBER	DESCRIPTION	SIZE	SUGG. RETAIL
30910583	Acorn	M, L, XL	\$88.00



BELTED DOVE GAME BAG

- 100% poly oxford fabric • Web belt with adjustable buckle
- Two large shell pockets with accessory pockets for choke tubes, glasses, etc. • Large bloodproof game bag with mesh sides for ventilation • Pockets slide on belt for easy positioning • Snap closures **SIZES** One size fits most

CODE NUMBER	DESCRIPTION	SIZE	SUGG. RETAIL
30910620	Mossy Oak Break-Up Infinity	one size	\$31.50



GAME VEST

- 100% poly oxford • Front load bloodproof game bag
- Elasticized shell loops • Large bellows pockets • Mesh sides and back for lightweight and increased ventilation
- SIZES** S-3XL

CODE NUMBER	DESCRIPTION	SIZE	SUGG. RETAIL
30517020	Mossy Oak Break-Up Infinity	S-XL	\$44.50
		2XL-3XL	50.50



DOVE VEST

- 7 oz. 55%/45% Cotton/poly twill fabric • Lightweight, comfortable design is ideal for hot weather • Mesh front and back panels provide greater breathability
- Two bellows shell pockets • Bloodproof rear game bag • Zippered front **SIZES** S-3XL

CODE NUMBER	DESCRIPTION	SIZE	SUGG. RETAIL
30510320	Mossy Oak Break-Up Infinity	S-XL	\$38.00
		2XL-3XL	44.50





Sand/Black

Sage/Black

Clay/Black

Black/Tan

TRAPPER CREEK MESH SHOOTING VESTS

- 100% poly mesh body for ventilation
 - Full-length 100% garment washed cotton twill shooting patch
 - Internal REACTAR™ G2 pad pocket (pad sold separately)
 - Four large shell pockets
 - Bar tacks at stress points
 - Side tab adjustments
 - Large rear pocket for hulls and other gear
- SIZES** S-3XL

CODE NUMBER	DESCRIPTION	SIZE	SUGG. RETAIL
30502628	NEW Sand/Black	S-3XL	\$55.00
30502654	NEW Sage/Black	S-3XL	55.00
30502668	NEW Clay/Black	S-3XL	55.00
30502689	NEW Black/Tan	S-3XL	55.00

REACTAR G2



Sage/Black

Black/Black

TRAPPER CREEK MESH HALF VEST

- Adjustable polyester web belt with speed buckle
 - Double, oversized shell pockets
 - Mesh shell pouch with zip bottom for easy emptying
- SIZES** One size fits most

CODE NUMBER	DESCRIPTION	SIZE	SUGG. RETAIL
30900754	NEW Sage/Black	one size	\$40.00
30900798	NEW Black/Black	one size	40.00



NEW



NEW

JUNIOR TRAPPER CREEK MESH SHOOTING VEST

- 100% poly mesh body for ventilation
 - Full-length 100% garment washed cotton twill shooting patch
 - Internal REACTAR™ G2 pad pocket (pad sold separately)
 - Two-way front zipper
 - Large shell pockets
 - Side tab adjustments
 - Large back pocket for empties or other gear
 - Inside security pocket
 - Buckmark and Claymaster embroidery
- SIZES** S (6-8), M (10-12), L (14-16), XL (18-20)

CODE NUMBER	DESCRIPTION	SIZE	SUGG. RETAIL
30505454	NEW Sage/Black	S-XL	\$50.00
30505489	NEW Black/Tan	S-XL	50.00

REACTAR G2

Sage/Black

Black/Tan



Stone/Tan



Clay/Tan

DUSTY MESH VEST

- 100% cotton, 10 oz. stonewash twill full-length shooting patches on right and left shoulders with sewn-in REACTAR™ G2 pad pockets (pad sold separately)
 - 100% polyester mesh body for ventilation
 - Two-way front zipper
 - Bellows shell pockets
 - Side tab adjustments
 - Large back pocket for empties or other gear
 - Inside security pocket
- SIZES** S-3XL

CODE NUMBER	DESCRIPTION	SIZE	SUGG. RETAIL
30502369	Stone/Tan	S-3XL	\$65.00
30502368	Clay/Tan	S-3XL	65.00

REACTAR G2





DELUXE MESH SHOOTING VEST

• Twill full-length shooting patch • Mesh body for ventilation • Two-way front zipper • Four large front shell pockets • Bar tacks at all stress points • Side tab adjustments • Large back pocket for empties or other gear • Built-in REACTAR™ G2 pad system • Split shoulder for ease of movement • 60% cotton, 40% poly twill • 100% polyester mesh **SIZES** Right-hand S-3XL, Left-hand M-2XL

CODE NUMBER	DESCRIPTION	SIZE	SUGG. RETAIL
30501779	Charcoal/Brown, Right-Hand	S-3XL	\$110.00
30502779	Charcoal/Brown, Left-Hand	M-2XL	110.00

REACTAR G2



SANTA FE PRO SHOOTING VEST

• Crazy Horse Leather full-length shooting patch and trim • Cotton twill and polyester mesh body for ventilation • Two-way front zipper • Four large front shell pockets • Bar tacks at all stress points • Back tab adjustments • Large back pocket for empties or other gear • Built-in REACTAR™ G2 pad system • Split shoulder for ease of movement • 100% polyester mesh • Interior security pocket **SIZES** S-2XL

CODE NUMBER	DESCRIPTION	SIZE	SUGG. RETAIL
30504154	Sage/Oak	S-2XL	\$195.00

REACTAR G2



SXS SUEDE SHOOTING VEST

• Polyester MicroSuede® full-length shooting patches on right and left shoulders with sewn-in REACTAR™ pad pockets (pad sold separately) • 100% polyester mesh body for ventilation • Two-way front zipper • Notched shoulders for easy movement • Four large shell pockets • Clip side adjustments • Large back pocket for empties or other gear • Inside security pocket • 3-D Buckmark embroidery on the front and Claymaster embroidery on the back

SIZES S-3XL

CODE NUMBER	DESCRIPTION	SIZE	SUGG. RETAIL
30501984	Olive/Brown	S-3XL	\$110.00

REACTAR G2

REACTAR G2



Charcoal/Yellow

REACTAR G2



Brown/Pink

REACTAR G2



Black/Brown

SPORTER II SHOOTING VEST FOR HER

- Polyester mesh front and back • Cotton twill trim • Full-length quilted shooting patches on right and left shoulders with sewn-in REACTAR™ G2 pad pockets (pad sold separately) • Button tab waist adjustment
- Two-way front zipper • Larger rear pocket for hulls and other gear • Buckmark embroidered pocket and Claymaster embroidered back yoke • Interior security pocket • Women's cut **SIZES S-2XL**

CODE NUMBER	DESCRIPTION	SIZE	SUGG. RETAIL
30506769	Charcoal/Yellow	S-2XL	\$72.50
30506788	Brown/Pink	S-2XL	72.50
30506789	Black/Brown	S-2XL	72.50

MOHAVE SHORT SLEEVE SHIRT FOR HER

- 100% polyester moisture-wicking pique fabric is perfect for hot weather • OdorSmart™ technology helps to control human odor
- Excellent moisture transfer • Crew neck
- Claymaster and Buckmark logo embroidery
- Women's cut **SIZES S-2XL**

CODE NUMBER	DESCRIPTION	SIZE	SUGG. RETAIL
30104341	Pink	S-2XL	\$40.00

REACTAR G2



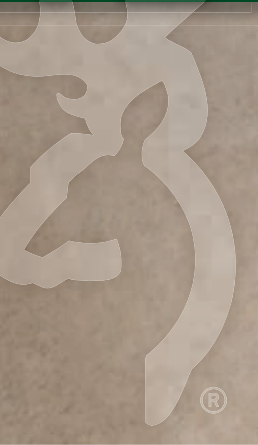

MOHAVE SHORT SLEEVE NTS POLO

- 100% polyester moisture-wicking pique fabric is perfect for hot weather
- OdorSmart™ technology helps to control human odor • Excellent moisture transfer
- Rib knit collar • Claymaster and Buckmark logo embroidery **SIZES** S-3XL

CODE NUMBER	DESCRIPTION	SIZE	SUGG. RETAIL
30104448	Sand	S-3XL	\$47.50
30104488	Brown	S-3XL	47.50
30104454	Pine	S-3XL	47.50



BADGER CREEK SHORT SLEEVE WOVEN SHOOTING SHIRT

- 100% garment-washed cotton • Internal REACTAR™ G2 pad pocket behind shooting patch (pad sold separately) • Mesh-lined turbo vent back for maximum air circulation
- Seven-button placket front • Button-down collar • Left front patch chest pocket
- SIZES** S-3XL



CODE NUMBER	DESCRIPTION	SIZE	SUGG. RETAIL
30103448	Sand	S-3XL	\$47.50
30103454	Pine	S-3XL	47.50
30103488	Brown	S-3XL	47.50
30103499	NEW Black	S-3XL	47.50



Black

REACTAR G2 PAD AND SHOOTING HARNESS

REACTAR G2

- REACTAR Shooting Pad: Our exclusive REACTAR G2 pad (REcoil ACTion ARrestor) absorbs recoil on the inside of vest, jacket or shirt without altering appearance or increasing length of pull • Uses patented, environmentally-friendly Impact Gel™ which reduces peak recoil • Only 8mm thick
- Lightweight • Flexible to form to the body

DIMENSIONS 3¾" W x 7" L • Harness has been updated for better fit • Includes REACTAR G2 pad • Heavy-duty 500 denier Cordura® • Reversible for use by right- or left-handed shooters • Elastic strap with buckle size adjustment **SIZES** One size fits most

CODE NUMBER	DESCRIPTION	SIZE	SUGG. RETAIL
309013	REACTAR G2 Pad, Gray	one size	\$27.50
309011	REACTAR Harness, Black	one size	50.00



REACTAR Harness



REACTAR G2 Pad

REACTAR G2

SHOULDER SAVER REACTAR NTS™ SHIRT

- Lightweight, stretchable polyester/Lycra® jersey fabric has superb moisture-moving and quick-drying properties • Anti-microbial to help kill odor-causing bacteria • Designed to be worn snug, Next to Skin, to keep REACTAR G2 Pad in place and move moisture • Oversized REACTAR G2 pad pocket on both shoulders (oversized REACTAR G2 pad included) **SIZES** S-3XL

CODE NUMBER	DESCRIPTION	SIZE	SUGG. RETAIL
30101347	REACTAR NTS Shirt, White	S-3XL	\$80.00



IMPACT GEL

REACTAR G2

REACTAR G2 PAD WITH IMPACT GEL™ FOR BETTER PERFORMANCE.

Shooting all day can take a heavy toll on your shoulder. Take the sting out of shooting with the REACTAR G2 pad. The REACTAR G2 pad features an ultra-flexible recoil absorption material called Impact Gel™ that absorbs recoil forces better than any other pad on the market. Most amazingly, the REACTAR G2 pad with Impact Gel performs so well at a thickness of only 8mm, it won't change your length of pull or affect your point of aim. To reap the benefits of greater comfort and less fatigue, try a Made in the USA REACTAR G2 pad today.

"There is no better endurance test on shooting gear than an Argentina dove hunt. After 3,300 shells fired in just three short days, I found Browning's new REACTAR shirt really performs. It's comfortable to wear, the pad is soft and molds right to your shoulder. The generous pad is oversized to cover a larger area on your shoulder so you are protected no matter where you shoulder your gun. The pad is thin enough that it doesn't affect mounting the gun or the length of pull. Best of all, I had no bruising or soreness. It's a must-have for anybody planning a full day of shooting, and it lives up to our motto, The Best There Is.®"

— Rafe Nielsen, Browning Product Manager



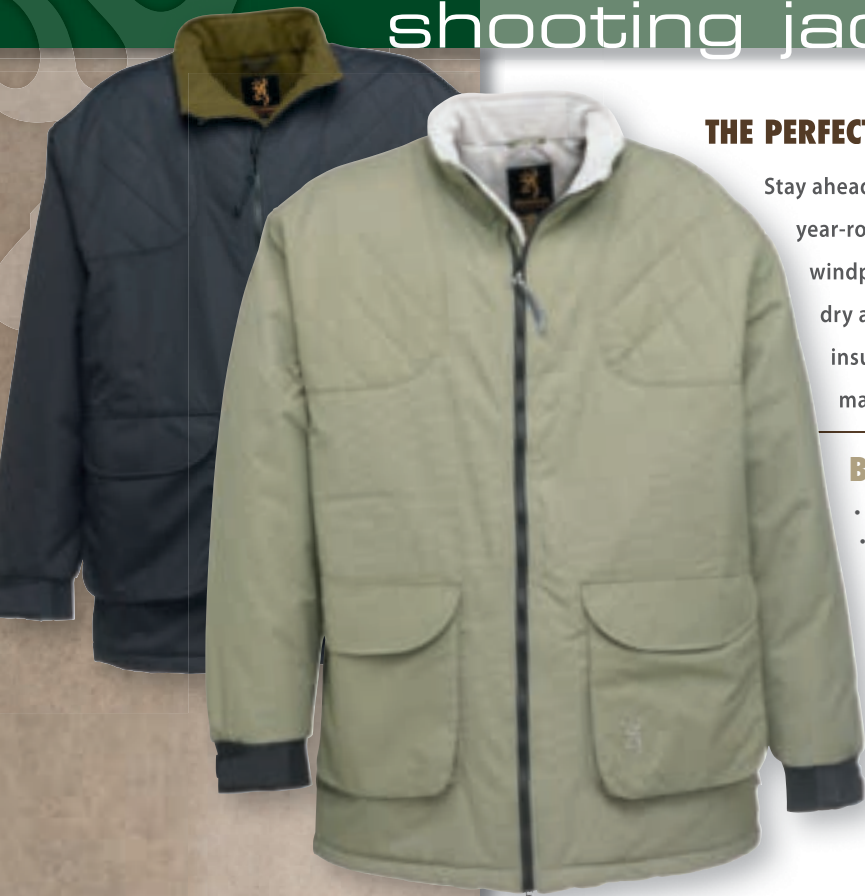

THE PERFECT JACKET FOR HOT SHOTS.

REACTAR™ G2

Stay ahead of your shooting competitors by dusting targets year-round in the Ballistic Shooting Jacket. The waterproof, windproof, breathable Pre-Vent® fabric keeps hardcore shooters dry and protected from the wind while the Thermolite® insulation adds warmth. Oversized shell pockets feature magnetic closures that hold the pocket flaps open or closed.

BALLISTIC INSULATED SHOOTING JACKET

- Pre-Vent® waterproof, windproof, breathable fabric • Warm insulation
- Double shooting patches accommodate both right- and left-hand shooters • REACTAR™ G2 pad pockets (pad sold separately) • Two bellows pockets with magnetic fasteners to hold flaps open or closed • T-cuffs • Stand-up, zip-through collar • Brushed tricot lining • Two-way front zipper • Neoprene cuffs with hook and loop adjustment tabs • Drawcord bottom • Buckmark and Claymaster embroideries **SIZES** S-3XL

CODE NUMBER	DESCRIPTION	SIZE	SUGG. RETAIL
30401354	Sage/Tan	S-3XL	\$160.00
30401399	Black/Green	S-3XL	160.00

PRE-VENT



A



B



C



D



E

LEATHER TAC-PRO GLOVES

- Unique textured palm enhances grip • Made from water- and perspiration-resistant Pittards® leather • Elasticized knuckles add comfort • Adjustable hook and loop closure with Buckmark embroidery • Washable, dries soft • Sizes: S-2XL

CODE NUMBER	DESCRIPTION	SIZE	SUGG. RETAIL
A 30701290	Black	S-2XL	\$85.00

MESH BACK SHOOTING GLOVES

- Lightweight, soft brushed synthetic suede • Stretch-mesh back for comfortable fit and enhanced air circulation • Hook and loop closure tab with Claymaster embroidery allows for adjustable, comfortable fit • Washable • Sizes: S-2XL

CODE NUMBER	DESCRIPTION	SIZE	SUGG. RETAIL
B 30701188	Tan/Black	S-2XL	\$32.50
C 30701190	Black	S-2XL	32.50

TRAPPER CREEK MESH BACK SHOOTING GLOVES

- Lightweight, soft brushed synthetic suede • Stretch-mesh back for comfortable fit and enhanced air circulation • Comfortable pull-on style • Washable • Sizes: S-2XL

CODE NUMBER	DESCRIPTION	SIZE	SUGG. RETAIL
D 30701399	Brown/Black	S-2XL	\$35.00

TRAPPER CREEK MESH BACK SHOOTING GLOVES, FOR HER

- Lightweight, soft brushed synthetic suede • Stretch-mesh back for comfortable fit and enhanced air circulation • Comfortable pull-on style • Washable • Sizes: S-2XL

CODE NUMBER	DESCRIPTION	SIZE	SUGG. RETAIL
E 30701488	Brown/Pink	S-2XL	\$35.00



CAPS — THE RIGHT CAP FOR EVERYONE.

We offer a wide selection of camo pattern caps, plus lightweight designs to keep you cool and looking great during the summer shooting competition months. Enjoy the comfortable fit and feel of a Browning cap while proudly displaying your favorite brand.



CAPS

CODE NUMBER	DESCRIPTION	CLOSURE	SUGG. RETAIL
RIMFIRE			
A	308379141 NEW MONBU	Hook and Loop Back	\$18.00
B	308379171 NEW MODB	Hook and Loop Back	18.00
C	308379201 NEW MOINF	Hook and Loop Back	18.00
D	308379211 NEW RTAP	Hook and Loop Back	18.00
E	308379221 NEW RTMX4	Hook and Loop Back	18.00
F	308379231 NEW RTMX1	Hook and Loop Back	18.00
NORTHFORK TWILL WITH REPEL-TEX BRIM			
G	308005171 NEW MODB/Brown	Hook and Loop Back	18.00
H	308005201 NEW MOINF/Brown	Hook and Loop Back	18.00
I	308005211 NEW RTAP/Brown	Hook and Loop Back	18.00
J	308005221 NEW RTMX4/Brown	Hook and Loop Back	18.00
DIRTY BIRD			
K	308131171 NEW MODB/Black	Hook and Loop Back	18.00
L	308131221 NEW RTMX4/Black	Hook and Loop Back	18.00
TATTER REED			
M	308130171 NEW Brown/MODB	Hook and Loop Back	20.00
N	308130221 NEW Taupe/RTMX4	Hook and Loop Back	20.00
RUGGED BUCKS			
O	308229201 NEW MOINF/Khaki	Hook and Loop Back	22.00
P	308229211 NEW RTAP/Brown	Hook and Loop Back	22.00
DEER SKULL AND RACK			
Q	308227201 MOINF	Hook and Loop Back	18.00
R	308227211 NEW RTAP	Hook and Loop Back	18.00
BIG BUCKMARK AND CAMO			
S	308204201 MOINF/Black	Hook and Loop Back	18.00
T	308204211 NEW RTAP/Black	Hook and Loop Back	18.00





QuikCamo



QUIK-CAMO FACE MASK CAP

- Brushed tricot fabric is quiet when moving through brush • Patent pending design features a drop down mesh face mask that hides your face quickly and easily • Face mask uses quick-drying, moisture-wicking breathable fabric • Eyewear compatible
- Ear holes for unobstructed hearing
- Mouth port for call access • Adjustable back • Mossy Oak® Duck Blind® and Realtree Max-4® camo caps have ear flaps • Buckmark embroidery

CAPS

	CODE NUMBER	DESCRIPTION	CLOSURE	SUGG. RETAIL
BREEZE MESH BACK				
A	308325201	MOINF/Tan	Hook and Loop Back	\$15.00
B	308325211	NEW RTAP/Black	Hook and Loop Back	15.00
EASTFORK				
C	308125201	MOINF	Hook and Loop Back	18.00
D	308125211	NEW RTAP	Hook and Loop Back	18.00
E	308125201R	MOINF/RMEF	Hook and Loop Back	18.00
GUNNER				
F	308129201	MOINF/Black	Hook and Loop Back	20.00
G	308129202	MOINF/Pink	Hook and Loop Back	20.00
3-D BUCKMARK FOR HER				
H	308179202	MOINF/Pink	Hook and Loop Back	18.00
I	308179212	NEW RTAP/Pink	Hook and Loop Back	18.00
WOODLAND CAMO				
J	308121411	Pink	Hook and Loop Back	18.00
NEEDLES WITH BUCKMARK				
K	308323241	Pink	Hook and Loop Back	18.00
L	308323291	Green	Hook and Loop Back	18.00
TATTER ALLTERRAIN				
M	308119241	Pink	Hook and Loop Back	15.00
N	308119291	Green	Hook and Loop Back	15.00
DIGI-CAMO				
O	308506291	Digi-Desert	Hook and Loop Back	18.00
QUIK-CAMO FACE MASK				
P	308128171	MODB	Hook and Loop Back	40.99
Q	308128201	MOINF	Hook and Loop Back	35.00
R	308128211	NEW RTAP	Hook and Loop Back	35.00
S	308128221	NEW RTMX4	Hook and Loop Back	40.00



SAFETY BLAZE CAPS – A SMART CHOICE IN THE FIELD.

A little visibility goes a long way, and wearing a Blaze cap in the field is a good idea. When upland hunting, a Blaze cap helps communicate to your hunting partners where you are in a corn field or tall grass. When big game hunting, Blaze lets other hunters see you from hundreds of yards away. But don't think for a second that a Blaze cap has to be boring. We offer several styles of Blaze caps that are both highly visible and look cool enough to wear to the mall and make it easier for your significant other to find you there too.

CAPS

CODE NUMBER	DESCRIPTION	CLOSURE	SUGG. RETAIL
SAFETY PLUS WITH 2-STRIPE BRIM			
T	308117011 Blaze/Yellow	Hook and Loop Back	\$18.00
SAFETY WITH 3-D BUCKMARK			
U	30840501 Blaze/Black	Hook and Loop Back	18.00
SAFETY PLUS WITH 3-D BUCKMARK			
V	308461001 Blaze/Yellow	Hook and Loop Back	18.00
EASTFORK BLAZE			
W	308125011 Blaze/Black	Hook and Loop Back	18.00
EASTFORK BLAZE ROCKY MOUNTAIN ELK FOUNDATION			
X	308125011R Blaze/Black	Hook and Loop Back	18.00
SAFETY PHEASANTS FOREVER EMBROIDERY			
Y	308126011 Blaze	Hook and Loop Back	18.00
DURA WAX WITH 3-D BUCKMARK			
Z	308412881 Brown	Hook and Loop Back	20.00
AA	308412511 Brown/Pink	Hook and Loop Back	20.00
LITE WAX WITH CORPORATE LOGO			
BB	308412581 Khaki	Hook and Loop Back	20.00
DURA WAX WITH CORPORATE LOGO			
CC	308412381 Olive	Hook and Loop Back	20.00
DD	3084121 Brown	Hook and Loop Back	20.00
REPEL-TEX CLOTH 2-TONE WITH 3-D BUCKMARK			
EE	308110341 Acorn/Olive	Hook and Loop Back	20.00
STRAW WITH REPEL-TEX BRIM			
FF	308106881 MOINF/Tan	Hook and Loop Back	22.50
RHINO HIDE			
GG	308328881 NEW Brown	Hook and Loop Back	15.00
NORTHFORK TWILL WITH REPEL-TEX BRIM			
HH	308005581 Khaki/Brown	Hook and Loop Back	18.00
II	308005841 Olive/Brown	Hook and Loop Back	18.00
JJ	308005991 NEW Black/Brn	Hook and Loop Back	18.00
RAGIN TATTER			
KK	308335511 NEW Pink/RTAP	Hook and Loop Back	20.00
LL	308335981 NEW Brn/RTAP	Hook and Loop Back	20.00





CAPS

	CODE NUMBER	DESCRIPTION	CLOSURE	SUGG. RETAIL
RUGGED BUCKS				
A	308229581	Khaki/MOINF	Hook and Loop Back	\$20.00
B	308229981	NEW Black/RTAP	Hook and Loop Back	20.00
SCOTT MESH BACK				
C	308337341	NEW Green	Snap and Tab	15.00
FANTASY FOREST MESH BACK				
D	308339511	NEW Pink/Brown	Snap and Tab	20.00
FASCINATING FOREST				
E	308339781	NEW Brown	Snap and Tab	20.00
78 BUCKMARK				
F	308338991	NEW Black	Hook and Loop Back	20.00
BLACK BUCK				
G	308008991	NEW Black	Hook and Loop Back	15.00
CORONADO PIQUE WITH BUCKMARK				
H	308007991	Black	Flex Fit	20.00
BREEZE MESH BACK				
I	308325241	Pink	Hook and Loop Back	15.00
J	308325381	Olive	Hook and Loop Back	15.00
K	308325681	Tan	Hook and Loop Back	15.00
FALINE SPANGLE				
L	308510511	Pink	Hook and Loop Back	18.00
M	308510991	NEW Black	Hook and Loop Back	18.00
BRIM SANDWICH TWILL WITH 3-D BUCKMARK				
N	308304211	Pink/Brown	Hook and Loop Back	18.00
O	308304521	Terra Cotta	Hook and Loop Back	18.00
P	308304641	NEW Olive/Black	Hook and Loop Back	18.00
Q	308304681	Mocha	Hook and Loop Back	18.00
R	308304711	Red	Hook and Loop Back	18.00
S	308304781	NEW Khaki/Black	Hook and Loop Back	18.00
T	308304791	Charcoal	Hook and Loop Back	18.00
U	308304981	NEW Brown/Gold	Hook and Loop Back	18.00



CAPS

CODE NUMBER	DESCRIPTION	CLOSURE	SUGG. RETAIL
SHRIKE TWILL WITH 3-D BUCKMARK			
V	Sand/Black	Hook and Loop Back	\$18.00
W	Sage/Black	Hook and Loop Back	18.00
X	Clay/Black	Hook and Loop Back	18.00
Y	NEW Black/Cream	Hook and Loop Back	18.00
CAP JACK FELT			
Z	Red/Black	Hook and Loop Back	20.00
JUNEAU FLEECE KNIT BEANIE			
AA	308519201 NEW MOINF	One Size	15.00
BB	308519211 NEW RTAP	One Size	15.00
KENAI KNIT BEANIE			
CC	308509011 NEW Blaze	One Size	15.00
DD	308509541 Sage	One Size	15.00
EE	308509841 NEW Olive	One Size	15.00
FF	308509881 NEW Brown	One Size	15.00
GG	308509991 Black	One Size	15.00
BISMARCK LITE FELT/OVERDYE HAT			
HH	30828028 Woods	S/M L/XL	80.00
II	30828088 Pecan Olive Drab	S/M L/XL	80.00



clothing sizing chart

FOR HER SIZES

	S	M	L	XL	2XL
SIZE	4 6 8	10 12 14	16 18 20		
NECK	11½" 12½" 12½"	13½" 13½" 14½"	15½" 15½"		
SLEEVE	30" 30" 31"	31" 32" 32"	33" 33" 34"		
BUST	33½" 34½" 35½"	36½" 38" 39½"	41" 43" 45"		
WAIST	25½" 26½" 27½"	28½" 30" 31½"	33" 35" 37"		
HIP	35½" 36½" 37½"	38½" 40" 41½"	43" 45" 47"		
INSEAM	30" 30" 30"	30" 32" 32"	32" 32" 32"		

JUNIOR SIZES

	S	M	L	XL
SIZE	6 8 10	12 14 16	18 20	
HEIGHT	45-48" 49-52" 53" 58" 59" 63" 66½" 68½"			
CHEST	26" 27" 28" 30" 31" 33" 35" 36½"			
WAIST	22½" 23½" 24" 25" 26" 27" 29" 30"			
HIP	27" 28" 30" 32" 33" 34" 34" 35½"			

Kid's caps: 6½", fits ages 18 months to 3 years old
Youth caps: 6¾", fits ages 4-9

MEN'S SIZES

SIZE	S	M	L	XL	2XL	3XL
NECK	14-14½"	15-15½"	16-16½"	17-17½"	18-18½"	18-19½"
SLEEVE	32-33"	33-34"	34-35"	35-36"	36-37"	36-37"
CHEST	37-39"	40-42"	43-45"	46-48"	49-51"	52-54"
WAIST	28-31"	32-35"	36-39"	40-43"	44-46"	47-49"

MEN'S GLOVES

SIZE	XS	S	M	L	XL
HAND	7-7½"	8-8½"	9-9½"	10-10½"	11-11½"

MEN'S GLOVES
Measure around the flat of the hand just below the knuckles, excluding the thumb.
Number of inches around hand equals glove size.

MEN'S APPAREL

Every garment is designed and built to the specifications on the charts above.
Offered in 3XL sizes in many styles, which are cut larger throughout.

decals



- High-quality vinyl resists cracking and fading
- Easy to apply and remove • Wide variety of colors and styles • Three sizes



Buckmark Decal Family Camo/Pink



Bouquet Buckmark, Black/Pink



Claymaster

BUCKMARK DECALS

DESCRIPTION	SIZE	COLOR	CODE NUMBER	SUGG. RETAIL
FLAT DECALS				
Buckmark Decal	4"	Camo	3922001914	\$3.00
Buckmark Decal	4"	White	3922004714	3.00
Buckmark Decal	4"	Silver	3922005914	3.00
Buckmark Decal	4"	Gold	3922007314	3.00
Buckmark Decal	4"	Black	3922009914	3.00
Buckmark Decal	6"	Camo	3922002916	5.00
Buckmark Decal	6"	Red/White/Blue	3922003116	5.00
Buckmark Decal	6"	Pink	3922004116	5.00
Buckmark Decal	6"	White	3922004716	5.00
Buckmark Decal	6"	Hot Pink	3922005116	5.00
Buckmark Decal	6"	Silver	3922005916	5.00
Buckmark Decal	6"	Chrome Silver	3922006916	5.00
Buckmark Decal	6"	Gold	3922007316	5.00
Buckmark Decal	6"	Black	3922009916	5.00
Buckmark Decal	12"	Camo	3922002911	15.00
Buckmark Decal	12"	Red/White/Blue	3922003111	15.00
Buckmark Decal	12"	NEW Pink	3922004111	15.00
Buckmark Decal	12"	White	3922004711	15.00
Buckmark Decal	12"	Gold	3922007311	15.00
Buckmark Decal 3-D	6"	Camo	3922012916	15.00
Buckmark Decal 3-D	6"	Red/White/Blue	3922013116	15.00
Buckmark Decal 3-D	6"	Silver	3922015916	15.00
Buckmark Decal 3-D	6"	Gold	3922017316	15.00
Buckmark Decal 3-D	6"	Black	3922019916	15.00
Claymaster Decal 3-D	3.5"	Orange	3922054	10.00
Buckmark Decal Reflective	6"	Amber	3922070642	6.00
Buckmark Decal Reflective	6"	Red	3922070661	6.00
Daisy Buckmark Decal	5"	Black/Pink	3922080551	10.00
Deer & Skull	5"	Black/Red	3922080561	10.00
Deer & Skull	5"	Black/Gold	3922080573	10.00
Deer & Skull	15"	Black/Gold	3922081573	18.00
Bouquet Buck	5"	Black/Pink	3922090551	10.00
Rugged Rack Trio	5"	Black/Orange	3922090582	10.00
Buckmark Faline Spangle	6"	NEW Pink	392220647	10.00
Buckmark Faline Spangle	6"	NEW Silver	392220659	10.00
Buckmark Family Decal	6"	MOBU/Pink	3922100014	20.00

HALL OF FAME

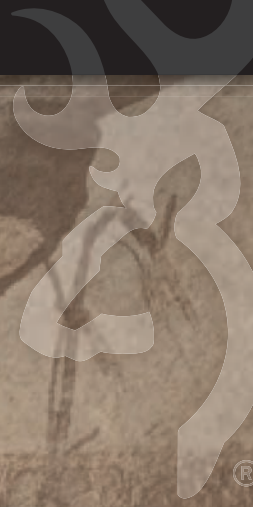

HALL OF FAME



RICK CAMUGLIA

is a long-time Browning shooter with multiple sporting clays titles, nearly all won with Browning autoloading shotguns. A short list of his victories includes multiple National and Regional FITASC Championships, nine-time New Mexico State Champion, two-time HOA Arizona State Champion and two-time HOA Colorado State Champion. He is also an eight-time NSCA All-American Team member. Rick prefers to shoot the Maxus® autoloader.

ANDY DUFFY

is the only shooter to win three NSCA National Championships, with back-to-back wins in 1994 and 1995. He has been on the NSCA All-American Team 17 times, Team USA 20 times and won more world, national and local sporting clays championship titles than he can shake a stick at. In 2005, he was honored by being inducted into the NSCA Hall-of-Fame. When Andy isn't dusting clays with his Citori®, you will find him instructing others in the ways of shotgunning.



MATT HUGHES

is a nine-time UFC® World Welterweight Champion and was inducted into the UFC Hall of Fame in 2010. Matt's toughness and work ethic are legendary in the UFC, something he attributes to growing up on a farm in rural Illinois. Matt spent a good portion of his early years hunting and shooting — passions that have never left him. Those passions now see him in front of the camera as the host of the Browning-sponsored "Trophy Hunters TV."

JOHNNY MEITZEN

started shooting competitively in 1987 and is currently a NSCA Level III instructor. He has won a number of shooting titles including two-time NSCA Nationals Vet Champion and two-time NSCA Nationals FITASC Vet Champion. Johnny is a six-time All-American Sporting Team member, two-time Team USA Sporting member and two-time Team USA FITASC member. He also has many state and zone championship titles to his credit. Johnny is a die-hard Citori® man. His current model of choice is the Citori 625 Sporting.



DEEANN MASSEY

was introduced to sporting clays shooting by her husband Jeff, who taught her to shoot in their backyard. She shot in her first tournament in the summer of 1996. In 1997, ten days before the Sporting Clays National Championship, she purchased her first 12 gauge Browning Gold. She used the Gold to tie for Ladies High Overall. Since then she has won two National Championships and has been a five-time runner-up. She has been on the 1st All-American Team twelve times and Team USA seven times. She has also won the Michigan State Ladies Championship twelve times, the Zone Three Ladies Championship ten times and has numerous other wins in local and regional competition. She has been a member of the Browning Pro Staff Team for thirteen years. DeeAnn currently shoots the Cynergy® over and under.





ROBBIE PURSER

started shooting skeet at the tender age of six. Over the years he has accumulated an impressive list of shooting titles including 1980 World Skeet Champion, 1991 and 1998 NSCA Champion, Zone 4 Champion, Quail Unlimited Champion, four-time Ducks Unlimited Champion, 2002 Sportsman Team Challenge Champion and an ESPN Great Outdoor Games gold medalist. He is also a twelve-time All-American Team member, a member of Team USA and a ten-time Georgia State Champion. All told, Robbie has more than 200 tournament wins to his credit — all with Browning autoloaders.



BRODY SIKES

is a rising star on the clay target scene, winning the 2010 North American Grand Prix FITASC event at Claythorne Lodge. Just 20 years old, Brody shoots a Browning Citori™ for clay targets and a Silver™ in the blind. A product of the popular SCTP development program, Brody and his Citori will be in the winner's circle for years to come.

ZAC COOPER

When Zac was born, his parents decided that instead of giving up hunting for a while, they would adapt to new ways of hunting. And at four months of age, Zac was on a plane to Iowa for a whitetail hunt. He took his first two deer at age five, and hunting has since become a way of life for Zac. He has gained national recognition for his speaking ability, and has been a guest speaker at such events as the 2009 QDMA National Convention, the University of Florida's Field Day, the Sportsman's Spectacular, and Florida's National Field Day. Zac is also a leader in school, serving in student government while maintaining straight-A grades. Zac has two long-term goals: To be a positive influence on today's youth and to help get them into the sport of hunting. See him in his hunting DVD titled "Little Man, Big Dreams."

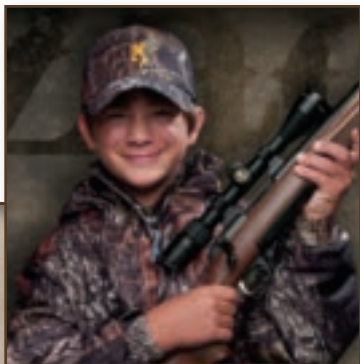

KRISTY LEE COOK

brought her amazing voice to the TV screen on the 7th season of "American Idol®." Now Kristy is a rising country music singer and hosts the Browning-sponsored TV show "Goin' Country." Kristy possesses an infectious passion for everything she does, whether it is performing, hunting or saving horses through the Kristy Lee Horse Heaven Foundation.



FRED ZINK

Fred founded Zink Calls™ in 2001 primarily to fulfill the needs of waterfowlers and professional callers who demanded high-end calls. A nationally-recognized goose caller in his own right, Zink's business continues to grow and set new standards in the call industry. Zink's high-octane 24/7 DVD series is designed to speak to hunters with exciting footage that shares the hunting experience with the viewers. In 2012, look for Fred to be shooting the Browning Maxus™ as he continues his quest to bring new hunters into the sport and grow the outdoor industry.



FOSTER AND MATT BARTHOLOW

are rising stars on the ATA trapshooting circuit, and both shoot Browning Citori shotguns. The brothers came up through the Scholastic Clay Target Program and have made their mark within the Open ranks. Whether in a shoot-off with legendary Leo Harrison III or winning the Preliminary Doubles event at the Grand American, both will tell you that the Citori shotgun is a workhorse that just keeps on shooting, round after round, year after year.



STEPHEN LE BLANC

A man of many talents, Stephen has a degree in wildlife biology, is a master taxidermist, an award-winning wildlife sculptor and an avid hunter. His impressive hunting résumé includes a North American Grand Slam of sheep and the Africa Big Five that consists of elephant, white rhino, cape buffalo, lion and leopard.



KIMLOR

INNOVATIVE HOME FASHIONS

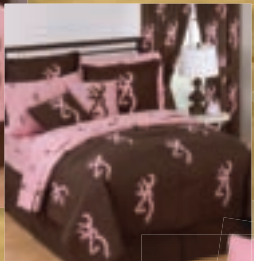

Browning trademarks licensed from Browning.

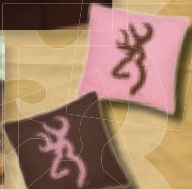

www.kimlor.com
 Phone 800.762.0007
 Fax 800.232.9060

These products manufactured and distributed by Kimlor Mills, Inc. Orangeburg, SC 29118



BROWNING

OUTDOOR COOKWARE

Now you can satisfy that urge to be a master Dutch oven chef. The Browning cast iron starter kit has everything you need to be a black pot professional. This kit is the perfect accessory for whatever you are cooking, at home or in the back country, and will help to make sure every meal is a masterpiece.

All Browning cast iron is pre-seasoned and ready to cook right out of the box. Easy to clean and maintain, Browning cast iron will be a family heirloom for generations.

CAST IRON SET

C30X-SR



- 12" Dutch Oven
- 12" Skillet
- 12" Universal Lid
- Gloves
- Lift Tool

Made Exclusively By:



www.campchef.com



BROWNING

BELTS

The Best There Is!

646.370.4650

www.browningleatherbelts.com



Tow & Stow™ Receiver Hitch

- Multiple Ball Sizes: 2 3/16", 2" & 1 7/8"
- Available in 3 adjustment lengths
- Raise or lower the hitch for a safe level tow
- Manufactured from steel
- Powder coated for a durable and long lasting finish
- 10,000 lbs. Trailer Weight /1,000 lbs. Tongue Weight



BROWNING

HITCHES



NEW STYLES - FOR 2012

HIGH PERFORMANCE HUNTING FOOTWEAR



BR8100 - Insulated Rubber Pull On Side Zipper

BR9104 - Insulated Waterproof Lace to Toe

1.800.441.4319 • www.browningfootwear.com

BROWNING
EYEWEAR AND ACCESSORIES

www.browningeyewear.com
Senatobia, MS 38668
Phone 800.416.0866 Fax 800.785.6563

BROWNING
SOCKS

Tall Merino Boot Western Boot Merino Wool Camo Merino Wool

Work Sock Dry Comfort Merino Wool Hiker Women's Angora Boot Kid's Camo Wool Blend

Browning Sock Collection
Provides Comfort and Protection for all Hunting, Hiking, Work and Casual Settings.

Carolina Hosiery Mills email: ekoury@carolinahosiery.com
tel 336.226.5581 fax 336.226.9721 www.browninghosiery.com



BROWNING

The Best There Is[®]

CASUAL SPORTSWEAR



SIGNATURE AUTOMOTIVE



GIFTS

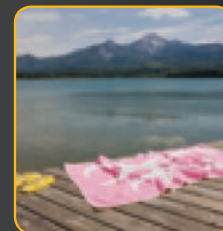

WWW.SPGCOMPANY.COM

1-800-553-1098

SPG
Signature Products Group

The Best There Is®



HU4030-014587

HU4030-014587 11 FOOT / 14 FOOT TRIPOD HUNTING STAND

- 300 POUND WEIGHT CAPACITY
- 360 DEGREE SWIVEL SEAT
- 26 INCH DIAMETER MESH PLATFORM
- SHOOTING REST
- 2 INCH SQUARE TUBING FRAME
- HOLDS UP TO 300 POUNDS



GR1008-013841A

GR1008-013841A DELUXE SMOKER

- SQUARE OFFSET FIREBOX AND SIDE GRILL
- COOKING CHAMBER: 840 SQUARE INCH COOKING SURFACE
- FIREBOX: 395 SQUARE INCH COOKING SURFACE
- HEAVY DUTY PORCELAIN COATED COOKING GRATES
- FRONT SHELF AND BOTTOM RACK FOR EXTRA STORAGE
- HEAVY DUTY STEEL CONSTRUCTION
- 16 INCH OVERSIZED WAGON STYLE WHEELS



OTHER BROWNING ITEMS: TRIPOD HUNTING STANDS, CHARCOAL GRILLS, TURKEY/FISH FRYERS, METAL COOLERS, BBQ TOOLS SETS, BUCKETS, BOAT SEATS & ACCESSORIES AND CARGO RACKS



Rankam (China) Manufacturing Company Limited

US office: Rankam Metal Products Manufactory Limited. 1618 W. Rosecrans Ave., Gardena, CA90249. USA
Tel: 248-330-8273 Monday thru Friday 8 A.M. to 5 P.M. Pacific Standard Time or by email browning@rankam.com



BROWNING
FISHING

Check out the line of equipment from **Browning Fishing in 2012.**

Topping off the broad range of Browning fishing products are the revolutionary Midas baitcasting reels—five state-of-the-art models that offer exceptional casting distance, amazing accuracy and the ability to perfectly fit any rod. Also in the lineup for 2012, Browning has perfected the take-along tackle bag with the 370 Satchel. In addition to its rugged construction, this one-of-a-kind tote provides room for all the gear you need.

FEED YOUR FEVER

GET GEAR PERFECT FOR ANY KIND OF FISHING



Browning 370 Satchel

For that next big fishing trip, grab the Browning 370! This large and tough bag lets you safely take along all your favorite fishing gear. • Durable PVC-backed nylon • Top-loading compartment for six 370 tackle boxes • Molded sunglass holder • Zippered side compartments • Removable shoulder strap • Secure, easy-access tool storage • Mesh rear pocket w/zipper • Color: Green/Gray • Imported • 20"x12"x15"

Browning Midas Baitcast Reel

With five "10-class" reels to choose from, Browning has a top-of-the-line, yet compact, Midas baitcaster that's ideal for any kind of fishing. • Powerful 1-pc. aluminum frame • Double-anodized, forged-aluminum V-spool • Aluminum recurve handle & drag star • 9 double-shielded stainless steel bearings, plus the Powerlock™ instant anti-reverse roller bearing • Externally-adjustable Fail-Safe Dual Braking w/centrifugal & magnetic cast control • Thumb bar spool release

FOR INFORMATION, PLEASE CALL: 1-800-227-7776
WWW.BROWNINGFISHING.COM



BROWNING
AIRGUNS

FIXED BARREL ACCURACY

UNDER LEVER POWERHOUSE

- Fiber optic sights
- Adjustable 2-stage trigger
- Automatic safety



LEVERAGE PELLET RIFLE

Velocity 1000 (177),
820 (22) FPS



©2011 Umarex USA • 7700 Chad Colley Blvd. • Fort Smith, AR 72916 • UmarexUSA.com



When going afield take
The Best There Is...
take Browning



www.browningbags.com

AmeriBag Outdoors • 5 AmeriBag Drive • Kingston, NY 12401 • 800.237.3224



Check out our
Browning Camping For Her



Browning has a rich tradition of providing exceptional products for the avid outdoorsman, and the Browning Camping line is no exception. Our furniture is wider and stronger, our pads and mats are thicker and more comfortable, and our tents and sleeping bags use larger zippers and better fabric. Along with all the other new and exciting products Browning Camping has to offer for 2012, we now have products designed specifically "for her." Be sure to check out the Pink Browning items listed on our website.



The Best There Is®

1.877.459.2825
www.browningcamping.com



Sleeping Bags • Furniture • Tents • Air Pads



POLARIS® AND BROWNING®, BRED TO HUNT.



HARDEST WORKING. SMOOTHEST RIDING®

The most powerful engines in their class, On-Demand True All-Wheel Drive, 12" of ground clearance, Lock and Ride® hunt accessories, and premium features. The new Sportsman XP 850 H.O. Browning Limited Edition and RANGER XP 800 Browning Limited Edition get you places others won't and carry out loads others can't. In other words, these machines hunt like no other.



GET THE PROOF.
To see Polaris vehicles in action, scan this code using any QR-code reader app on your smartphone.

TO SEE THE COMPLETE LINE OF BROWNING LIMITED EDITION POLARIS ATVs AND SIDE X SIDES, VISIT POLARIS.COM/BROWNING.

Always use common sense and proper equipment. Warning: ATVs can be hazardous to operate. For your safety, avoid operating Polaris ATVs or BROWNING on paved surfaces or public roads. Riders and passengers should always wear helmets, eye protection, protective clothing, and don't drink and operate. Always carry passengers unless the vehicle has been designed by the manufacturer for that purpose. Polaris and BROWNING ATVs are for riders aged 16 and older. Riders of BROWNING vehicles must be at least 18 years old with a valid driver's license. All ATVs must operate with a safety training course. For ATVs safety and training information in the U.S., call the UVA at (800) 860-2662, see your dealer, or call Polaris at (800) 340-3104. In Canada, see your local Polaris dealer about Polaris ATVs. Check your local laws before riding on trails. ©2013 Polaris Industries Inc. "Browning and Bred to Hunt" are trademarks of Browning Corporation. Browning and BROWNING design are registered trademarks of Browning Corporation.

THE BROWNING NAME IS STILL FIRST IN THE FIGHT FOR FREEDOM.

The name of John M. Browning remains legendary in elite military and police circles. No other individual has contributed more to the security of our great country and to the individual safety of many generations of our warriors.

As such, it's natural that the tactical reputation of John M. Browning be carried forward with pride among today's generation of elite tactical and security professionals.

Our mission was straightforward. Design the most functional and innovative tactical blades possible, using the finest materials and most modern manufacturing processes available to produce the ultimate knives for the working professional. The result is Browning's new Black Label Tactical Blades.

We think John M. Browning would be very proud that a new generation of warriors will proudly carry his name into today's battle for freedom.

Designed in the USA by Russ Kommer



RUSS KOMMER

Russ Kommer is a world leader in cutting edge knife design. Browning's Black Label Tactical Blades represent his latest project, bringing custom grade workmanship, exquisite materials and cutting edge design together to produce the most efficient and exotic tactical blades available anywhere, at any price.

Made in the USA



108BL

NEW

ALL-AMERICAN FIXED BLADES

TYPE Fixed blade **BLADES** Hollow ground satin finish 154CM stainless steel • Unique Black Label Tactical Blades logo **HANDLES** Full-tang construction • Textured black G-10 scales **SHEATH** Blade-Tech™ molded polymer sheath with Tek-Lok™ belt clip easily adjusts for carry angle and belt loop width **FEATURES** Special Black Label box • Made in the USA

The Blade-Tech™ molded polymer sheath features the Tek-Lok™ belt clip that easily adjusts for carry angle and belt loop width.

MODEL	DESCRIPTION	BLADE LENGTH	BLADE TYPE	CODE NUMBER	SUGG. RETAIL
NEW 104BL	Shadowfax	4 ⁵ / ₈ "	Mod. Drop Point	320104BL	\$249.95
NEW 102BL	Boot Dagger	3 ¹⁵ / ₁₆ "	Double Edge	320102BL	169.95
NEW 103BL	Arbitrator	5 ¹ / ₂ "	False Edge	320103BL	169.95
NEW 101BL	Deterrent	2 ³ / ₄ "	Talon Blade	320101BL	149.95
NEW 108BL	Volatile Push Dagger	2 ⁷ / ₈ "	Double Edge	320108BL	149.95



JARED WIHONGI

With 25 years of international martial arts experience under his multiple black belts (particularly the formidable Filipino blade fighting system of Pekiti-Tirsia Kali), New Zealand native and SWAT officer Jared Wihongi is a force to be reckoned with in the tactical knife world. He endorses Browning's Black Label Tactical Blades, knowing they meet the requirements of the most demanding professional operators.

JARED
WIHONGI



NEW

ALL-AMERICAN FOLDERS

TYPE Folding blade **BLADES** Hollow ground satin finish or black oxide 154CM stainless steel • Unique Black Label Tactical Blades logo

HANDLES Robust liner lock construction • Textured black G-10 scales • Four-way adjustable tactical pocket clip

FEATURES Special Black Label box • Made in the USA

MODEL	DESCRIPTION	BLADE LENGTH	BLADE TYPE	CODE NUMBER	SUGG. RETAIL
NEW 105BL	Perfect Storm	3 ⁷ / ₈ "	Tanto	320105BL	\$179.95
NEW 100BL	Hell Fire	3 ⁹ / ₁₆ "	Tanto	320100BL	174.95
NEW 107BL	Undisputed	3 ³ / ₈ "	Deep Belly	320107BL	164.95

Made in the USA



BLACK LABEL
TACTICAL BLADES

HARD CORE TACTICAL TOOLS.

These magnificent fixed blade knives are proof that Black Label beauty is more than skin deep. From their razor sharp partially serrated edges to their hardened steel glass breaking points, these robust blades are ready and able to help you cut, pry, slash and smash your way into or out of any tactical situation.



★ *Designed in the USA by Russ Kommer*

The hardened steel glass breaking point allows you to shatter auto or window glass for entry or escape.

HARD CORE UTILITY FIXED BLADES

NEW

TYPE Fixed blade **BLADES** Hollow ground black oxide 440 stainless steel • Stone Cold models have partially serrated edges • Unique Black Label Tactical Blades logo **HANDLES** Full-tang construction • Hardened steel glass breaking point • Textured black G-10 scales or hand-laced gray and tan digital camo paracord with knotted wrist lanyard • Lanyard hole **SHEATH** Blade-Tech™ molded polymer sheath with Tek-Lok™ belt clip on fixed blade models easily adjusts for carry angle and belt loop width **FEATURES** Special Black Label box

MODEL	DESCRIPTION	BLADE LENGTH	BLADE TYPE	CODE NUMBER	SUGG. RETAIL
NEW 117BL	Stone Cold Tanto Cord	5 5/8"	Tanto	320117BL	\$59.95
NEW 118BL	Stone Cold Spear Cord	5 5/8"	Spear Point	320118BL	59.95
NEW 115BL	Stone Cold Tanto G-10	5 5/8"	Tanto	320115BL	59.95
NEW 116BL	Stone Cold Spear G-10	5 5/8"	Spear Point	320116BL	59.95
NEW 130BL	First Priority	2 1/4"	Tanto	320130BL	49.95

**TRADITIONAL CLASSICS
MADE MODERN.**

No Browning tactical knife collection would be complete without these Point Blank models. A tribute to the classic U.S. military fighting blades of the past, their beefy clip point blades and hidden tangs are updated by using the most modern steels and molded modular polymer sheaths. The rugged and robust Pandemonium fixed and folding knives offer a new compound curve edge profile that makes the traditional deep belly blade shape even more useful.

**HARD CORE UTILITY FIXED
AND FOLDING BLADES**

NEW

TYPE Fixed blade on Point Blank • Fixed or folding blade on Pandemonium
BLADES Hollow ground, bead blasted or black oxide 440 stainless steel
 • Unique Black Label Tactical Blades logo **HANDLES** Hidden tang on Point Blank • Full-tang construction on Pandemonium fixed blade • Stacked leather or black G-10 scales **SHEATH** Blade-Tech™ molded polymer sheath with Tek-Lok™ belt clip on fixed blade models easily adjusts for carry angle and belt loop width **FEATURES** Special Black Label box



The sculpted finger grooves on the Point Blank fixed blade models offer improved grip in all conditions.

MODEL	DESCRIPTION	BLADE LENGTH	BLADE TYPE	CODE NUMBER	SUGG. RETAIL
NEW 112BL	Point Blank Leather	6"	Clip Point	320112BL	\$59.95
NEW 111BL	Point Blank G-10	6"	Clip Point	320111BL	59.95



MODEL	DESCRIPTION	BLADE LENGTH	BLADE TYPE	CODE NUMBER	SUGG. RETAIL
NEW 126BL	Pandemonium Fixed	4¼"	Compound	320126BL	\$49.95
NEW 124BL	Pandemonium Folder	3½"	Compound	320124BL	29.95

Designed
in the USA
by
Russ Kommer

TACTICAL UTILITY.

The heavy-duty folder is the must have, go-to utility tool of every tactical professional. Carried in your pocket, on your tactical vest, lashed to your web gear or discreetly tucked away in your briefcase or purse, the utility folder is the one blade that gets a real workout, day in and night out. Browning Black Label tactical folders are more than equal to any task and any situation.



NEW

TACTICAL UTILITY FOLDERS

TYPE Folding blade **BLADES** Hollow ground 440 stainless steel • Black oxide or titanium nitride (TiN) blade finish • Thumbstud • Unique Black Label Tactical Blades logo **HANDLES** Robust liner lock construction • Textured black G-10 scales • Four-way adjustable tactical pocket clip

FEATURES Stone Cold models have hardened glass breaking point and flipper blade opening tab • Special Black Label box

MODEL	DESCRIPTION	BLADE LENGTH	BLADE TYPE	CODE NUMBER	SUGG. RETAIL
NEW 123BL	Integrity TiN	3¾"	Tanto	320123BL	\$29.95
NEW 113BL	Stone Cold Tanto	3¾"	Tanto	320113BL	34.95
NEW 114BL	Stone Cold Spear Point	3¾"	Spear Point	320114BL	34.95
NEW 119BL	Flash Tanto	3¾"	Tanto	320119BL	24.95
NEW 120BL	Flash Spear Point	3¾"	Spear Point	320120BL	24.95



4-Way Pocket Clips can be adjusted for tip up or tip down carry on either side.



BLACK LABEL
TACTICAL BLADES

TACTICAL ELEGANCE.

Whoever said tactical blades had to be bold, black and brutish has never handled a Browning Black Label Sliver or Turning Point folder. These knives exude a subtle grace from every angle that we like to call "tactical elegance." Sleek yet strong, these compact blades represent the pinnacle of highly functional yet stylish tactical knives. You'll find they are equally at home for a day in the field or a night out on the town, and give you an added sense of personal security wherever they are carried.

**Designed
in the USA by
Russ Kommer**



NEW FULL DRESS FOLDERS

TYPE Folding blade **BLADES** Hollow ground 440C stainless steel • Satin or laser etched blade finish • Thumbstud • Unique Black Label Tactical Blades logo
HANDLES Robust liner lock construction • Textured black G-10 or carbon fiber grip scales • Two-way adjustable tactical pocket clip
FEATURES Special Black Label box

MODEL	DESCRIPTION	BLADE LENGTH	BLADE TYPE	CODE NUMBER	SUGG. RETAIL
NEW 134BL	Turning Point G-10	3"	Drop Point	320134BL	\$94.95
NEW 133BL	Turning Point Carbon	3"	Drop Point	320133BL	99.95
NEW 132BL	Sliver G-10	3"	Spearg Point	320132BL	94.95
NEW 131BL	Sliver Carbon Fiber	3"	Spearg Point	320131BL	99.95

GRAB A HANDFUL OF SHOCK N' AWE.

When the going gets tough, the tough reach for the ultimate Black Label Tactical Blade; the Shock N' Awe Tomahawk. Capable of anything from splitting kindling at your base camp to hacking your way out of a crashed helicopter, this tactical tool will make you one tough customer when serious trouble comes calling.

★ *Designed in the USA by Russ Kommer*



NEW

SHOCK N' AWE TOMAHAWK

- TYPE** Combat tomahawk **BLADE** Hollow ground, black powder coated sword-grade forged 1055 stainless steel • Curved penetration spike
- Unique Black Label Tactical Blades logo
 - HANDLES** One-piece handle with spiked pommel • Hand-wrapped black nylon paracord • Lanyard hole
 - SHEATH** Blade-Tech™ molded polymer sheath with Tek-Lok™ belt clip easily adjusts for carry angle and belt loop width
 - FEATURES** Special Black Label box

MODEL	DESCRIPTION	BLADE LENGTH	BLADE TYPE	CODE NUMBER	SUGG. RETAIL
NEW 110BL	Shock N' Awe Tomahawk	23 1/4"	Combat Tomahawk	320110BL	\$79.95

110BL

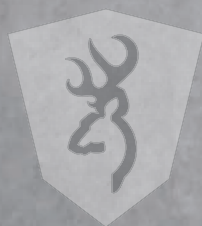

BLACK LABEL
TACTICAL BLADES

★ Designed
in the USA by
Russ Kommer

SPECIAL BLADES FOR SPECIAL OPERATORS.

Special tasks require special tools, and none fill the bill better than these highly specialized knives from Black Label Tactical Blades. From undercover neck knives to throwing knives and elegant tactical desk accessories, you'll be properly prepared to do battle with everyday paperwork or dangerous desperados.



A Kydex® neck sheath with matte black chain keeps the Tracer ready for instant use.

121BL



122BL



125BL

SPECIALTY KNIVES

NEW

TYPE Fixed blades **BLADES** Hollow ground, satin-finished 154CM or black oxide 440 stainless steel • Unique Black Label Tactical Blades logo **HANDLES** Full tang handle • G-10 handle scales on most models • Matte black ribbed aluminum alloy body and hardened glass breaking point on Tactical Pen **SHEATHS** Kydex® sheath on Tracer Neck Dagger and Tactical Letter Opener • Nylon sheath on Stick-It Throwing Knife Set **FEATURES** Special Black Label box

MODEL	DESCRIPTION	BLADE LENGTH	BLADE TYPE	CODE NUMBER	SUGG. RETAIL
NEW 121BL	Tracer Neck Dagger	2"	Double Edge	320121BL	\$19.95
NEW 122BL	Stick-It Throwing Set	4"	Double Edge	320122BL	\$39.95
NEW 125BL	Tactical Pen/Letter Opener Office Set	5"	Double Edge	320125BL	\$49.95



PRSRT BPM
U.S. POSTAGE PAID
PERMIT 179
OGDEN, UT

BROWNING
ONE BROWNING PLACE
MORGAN, UT 84050

A5



725
CITORI



BROWNING

Browning ▶ One Browning Place ▶ Morgan, UT 84050-9326
Distributed in Canada by: Browning Canada Sports Ltd./Ltee
5583 Chemin St-Francois ▶ St-Laurent, Quebec H4S 1W6

BROWNING.COM 800-333-3288

©Copyright, Browning, December 2012. No part of this catalog may be reproduced without the written permission of Browning. Printed in U.S.A. GAC1112200/11376

BE A SAFE SHOOTER Read and follow all safety information in the owner's manual provided with each firearm before using the firearm. Additional copies are available for free download on the Browning website. Browning endeavors to make the safest firearms possible, however, firearm safety begins with you. At all times treat any firearm with intense respect for its power and potential danger. Always point the muzzle in a safe direction. There is no excuse for careless or abusive handling of any firearm.



BROWNING IS COMMITTED TO SERVING YOU Every effort has been made to ensure that all product photographs, descriptions and specifications in this workbook are accurate; however, inadvertent errors may occur. Changes in design or materials due to our continual effort to improve products may result in specification changes before subsequent publications are issued. Browning reserves the right to modify or change specifications without notice. If you have any questions regarding Browning products, please write to Browning, One Browning Place, Morgan, UT 84050-9326.

